



Safe management of wastes from health-care activities

Second edition

Edited by Yves Chartier, Jorge Emmanuel, Ute Pieper,
Annette Prüss, Philip Rushbrook, Ruth Stringer,
William Townend, Susan Wilburn and Raki Zghondi

Safe management of wastes from health-care activities

2nd edition



WHO Library Cataloguing-in-Publication Data

Safe management of wastes from health-care activities / edited by Y. Chartier et al. – 2nd ed.

I. Medical waste. 2. Waste management. 3. Medical waste disposal – methods. 4. Safety management. 5. Handbook. I. Chartier, Yves. II. Emmanuel, Jorge. III. Pieper, Ute. IV. Prüss, Annette. V. Rushbrook, Philip. VI. Stringer, Ruth. VII. Townend, William. VIII. Wilburn, Susan. IX. Zghondi, Raki. X. World Health Organization.

ISBN 978 92 4 154856 4

(NLM classification: WA 790)

© World Health Organization 2014

All rights reserved. Publications of the World Health Organization (WHO) are available on the WHO web site (www.who.int) or can be purchased from WHO Press, World Health Organization, 20 Avenue Appia, 1211 Geneva 27, Switzerland (tel.: +41 22 791 3264; fax: +41 22 791 4857; e-mail: bookorders@who.int).

Requests for permission to reproduce or translate WHO publications – whether for sale or for non-commercial distribution – should be addressed to WHO Press through the WHO web site (www.who.int/about/licensing/copyright_form/en/index.html).

The designations employed and the presentation of the material in this publication do not imply the expression of any opinion whatsoever on the part of the WHO concerning the legal status of any country, territory, city or area or of its authorities, or concerning the delimitation of its frontiers or boundaries. Dotted lines on maps represent approximate border lines for which there may not yet be full agreement.

The mention of specific companies or of certain manufacturers' products does not imply that they are endorsed or recommended by WHO in preference to others of a similar nature that are not mentioned. Errors and omissions excepted, the names of proprietary products are distinguished by initial capital letters.

All reasonable precautions have been taken by WHO to verify the information contained in this publication. However, the published material is being distributed without warranty of any kind, either expressed or implied. The responsibility for the interpretation and use of the material lies with the reader. In no event shall the WHO be liable for damages arising from its use.

The named editors alone are responsible for the views expressed in this publication.

Declarations of interest

The members of the health-care waste-management working group completed the WHO standard form for declaration of interests prior to the meeting. At the start of the meeting, all participants were asked to confirm their interests, and to provide any additional information relevant to the subject matter of the meeting. It was from this working group that chapter authors and lead editors were selected.

None of the members declared current or recent (<1 year) financial interests related to commercial organizations.

Two members declared consultation contracts for work relevant to the subject matter of the meeting.

Bill Townend: Consultant for two industry nongovernment organizations, one of which – the International Solid Waste Association – is a nongovernmental organization in official relations with WHO, and provided technical and financial support for the publication.

Ute Pieper: Consultant in health-care waste management in projects financed by international agencies, development banks and bilateral government agreements.

These interests were not considered to give rise to a conflict with the aims of the meeting and the publication arising from the meeting and formed the basis of the expertise of the panel.

The following participants were adjudged to have no potentially conflicting interests in the subject matter of the meeting, based on their completed declarations: Jorge Emmanuel, Philip Rushbrook and Ruth Stringer.

Cover images (from top to bottom): tacartoons | Dreamstime.com; Jorge Emmanuel; J. Emmanuel; Sudoku | Dreamstime.com; J. Emmanuel; Global Methane Initiative (GMI) program; J. Emmanuel

Technical editing and design by Biotext, Australia

Printed in Malta

Contents

Foreword to the first edition	xiii
Acknowledgements	xv
Acronyms and abbreviations	xvii
1 Introduction	1
2 Definition and characterization of health-care waste	3
2.1 General definition and classification	3
2.1.1 Sharps waste	4
2.1.2 Infectious waste	4
2.2 Pathological waste	5
2.3 Pharmaceutical waste, including genotoxic waste	5
2.4 Chemical waste	6
2.5 Radioactive waste	8
2.6 Non-hazardous general waste	8
2.7 Sources of health-care waste	9
2.8 Generation of health-care waste	11
2.9 Physicochemical characteristics	15
2.10 Minimum approach to overall management of health-care waste	20
2.11 Desirable improvements to the minimum approach	21
2.12 References and further reading	21
3 Risks associated with health-care waste	25
3.1 Overview of hazards	25
3.1.1 Types of hazards	25
3.1.2 Persons at risk	25
3.1.3 Hazards from infectious waste and sharps	26
3.1.4 Hazards from chemical and pharmaceutical waste	28
3.1.5 Hazards from genotoxic waste	29
3.1.6 Hazards from radioactive waste	30
3.1.7 Hazards from health-care waste-treatment methods	30
3.2 Public sensitivity	31
3.3 Public health impact	31
3.3.1 Impacts of infectious waste and sharps	31
3.3.2 Impacts of chemical and pharmaceutical waste	34
3.3.3 Impacts of genotoxic waste	34
3.3.4 Impacts of radioactive waste	34
3.4 Survival of pathogenic microorganisms in the environment	34
3.5 The need for further research and epidemiological surveys	35
3.6 References and further reading	36
4 Legislative, regulatory and policy aspects of health-care waste	41
4.1 Importance of a national policy	41
4.2 Guiding principles	41
4.3 International agreements and conventions	42
4.3.1 The Basel Convention	42

4.3.2	The Bamako Convention	43
4.3.3	The Stockholm Convention.....	43
4.3.4	The environment and sustainable development conferences	43
4.3.5	United Nations Committee of Experts on the Transport of Dangerous Goods	44
4.3.6	United Nations Economic Commission for Europe	44
4.3.7	Aarhus Convention of the United Nations Economic Commission for Europe	45
4.4	Available guidance	45
4.4.1	World Health Organization Guidance	45
4.4.2	The International Solid Waste Association	46
4.4.3	ISWA policy document on health-care waste management.....	47
4.5	National legislation	47
4.6	Technical guidelines	48
4.7	Minimum approach to developing health-care waste-management policy	48
4.8	Desirable improvements to the minimum approach	48
4.9	References and further reading.....	49
5	Health-care waste-management planning.....	51
5.1	The need for planning	51
5.2	National plans	52
5.2.1	Purpose of a national health-care waste-management plan	52
5.2.2	Action plan for developing a national programme	52
5.3	Waste-management plan for a health-care facility	56
5.3.1	Assignment of responsibilities.....	56
5.3.2	Management structure, liaison arrangements and duties.....	57
5.3.3	Assessment of waste generation	61
5.3.4	Development of a hospital waste-management plan	62
5.3.5	Implementation of the waste-management plan	64
5.4	Minimum approach to planning	65
5.5	Desirable improvements to the minimum approach.....	65
5.6	References and further reading.....	65
6	Health-care waste minimization, reuse and recycling.....	67
6.1	The waste-management hierarchy	67
6.2	Waste minimization	68
6.3	Environmentally preferable purchasing	68
6.4	Green procurement.....	69
6.4.1	Recycling symbols for plastics	69
6.5	Safe reuse.....	70
6.6	Recycling and recovery.....	71
6.7	Environmental management systems	73
6.8	Minimum approach to waste minimization.....	74
6.9	Desirable improvements to the minimum approach	74
6.10	References and further reading.....	75
7	Segregation, storage and transport of health-care waste	77
7.1	Guiding principles	78
7.2	Segregation systems.....	78
7.2.1	Waste containers, colour codes and labels.....	78
7.2.2	Beyond basic segregation	82

	7.2.3	Waste containers: specifications and siting	83
	7.2.4	Setting and maintaining segregation standards	85
7.3		Collection within the health-care facility	86
7.4		Interim storage in medical departments	86
7.5		Onsite transport of waste	87
	7.5.1	General requirements	87
	7.5.2	Transport trolleys.....	87
	7.5.3	Routing.....	88
7.6		Central storage inside health-care facilities	89
	7.6.1	General requirements	90
	7.6.2	Hazardous waste storage.....	91
	7.6.3	Layout of waste-storage areas	94
	7.6.4	Documentation of the operation of storage places	95
7.7		Offsite transport of waste	95
	7.7.1	Logistic staff.....	95
	7.7.2	Vehicle requirements.....	96
	7.7.3	Labelling of the transport vehicle.....	97
	7.7.4	Cleaning of container and vehicle	99
	7.7.5	Transport documentation	99
7.8		Minimum approach to segregation, storage and transport	102
7.9		Desirable improvements to the minimal approach	102
7.10		References and further reading.....	103
8		Treatment and disposal methods	105
8.1		Selection of treatment methods	105
8.2		Overview of waste-treatment technologies	106
	8.2.1	Thermal processes	106
	8.2.2	Chemical processes	106
	8.2.3	Irradiation technologies	107
	8.2.4	Biological processes	107
	8.2.5	Mechanical processes.....	107
8.3		Suitability of treatment methods for infectious waste.....	107
8.4		Steam treatment technologies	108
	8.4.1	Autoclaves	108
	8.4.2	Integrated steam-based treatment systems	111
8.5		Microwave treatment technologies	112
8.6		Dry-heat treatment technologies	113
8.7		Chemical treatment technologies.....	113
	8.7.1	Internal shredding of waste	114
	8.7.2	Chemical disinfectants.....	114
	8.7.3	Microbial resistance.....	115
	8.7.4	Alkaline hydrolysis	116
8.8		Incineration	116
	8.8.1	Combustion.....	116
	8.8.2	Pyrolysis and gasification	117
	8.8.3	Required waste characteristics	118
	8.8.4	Energy recovery	118
	8.8.5	Types of incinerators for health-care waste.....	119

	8.8.6	Environmental control of incinerators	121
	8.8.7	Dust removal.....	124
8.9		Encapsulation and inertization	125
8.10		Emerging technologies.....	126
8.11		Applications of treatment and disposal methods to specific waste categories	127
	8.11.1	Sharps.....	127
	8.11.2	Anatomical waste, pathological waste, placenta waste and contaminated animal carcasses	128
	8.11.3	Pharmaceutical waste	129
	8.11.4	Cytotoxic waste	129
	8.11.5	Chemical waste	130
	8.11.6	Waste containing heavy metals.....	131
8.12		Land disposal	133
	8.12.1	Municipal and other external disposal sites.....	134
8.13		Minimum approach to treatment and disposal.....	136
8.14		Desirable improvements to the minimum approach	137
8.15		References and further reading	138
9		Collection and disposal of wastewater	147
	9.1	Characteristics of health-care wastewater	147
	9.2	Hazards of wastewater from health-care facilities.....	147
	9.2.1	Wastewater-related diseases.....	148
	9.2.2	Hazards from liquid chemicals in wastewater	149
	9.2.3	Hazards from pharmaceuticals in wastewater.....	149
	9.2.4	Hazards from radioactive substances.....	150
	9.2.5	Quantity of wastewater.....	150
	9.2.6	Quality of wastewater by hospital department	150
	9.3	Collection and pretreatment of liquid health-care waste.....	151
	9.3.1	Sewerage systems for health-care facilities.....	151
	9.3.2	Pretreatment of hazardous liquids	152
	9.4	Discharge into municipal sewage systems.....	153
	9.5	Onsite wastewater treatment	153
	9.5.1	Wastewater-treatment systems	153
	9.5.2	Disinfection of wastewater	155
	9.5.3	Disposal of sludge	155
	9.5.4	Emerging technologies.....	156
	9.5.5	Reuse of wastewater and sludge	156
	9.5.6	Offsite treatment and disposal in specialized facilities.....	157
	9.6	Operation and monitoring of sewerage systems.....	157
	9.6.1	Operation and maintenance of wastewater systems	157
	9.6.2	Monitoring of wastewater systems	157
	9.7	Minimum approach to wastewater management.....	158
	9.7.1	Sanitation system.....	158
	9.7.2	Minimal liquid hazardous waste-management system	158
	9.7.3	Basic wastewater-treatment systems	159
	9.8	Desirable improvements to the minimum approach.....	162
	9.9	References and further reading.....	163

10	Economics of health-care waste management	165
10.1	Guiding principles	165
10.2	Cost elements.....	166
10.2.1	Costs at a health-care facility level	166
10.2.2	Costs at a central treatment facility level	167
10.2.3	Costs at a national level.....	168
10.3	Cost estimation.....	168
10.4	Cost and financing.....	174
10.4.1	Methods of financing	174
10.4.2	Costing tools	175
10.4.3	Pricing models for a treatment provider	177
10.5	Recommendations for cost reductions.....	178
10.6	Minimum approach to health-care waste management costing	178
10.7	Desirable improvements to the minimum approach	179
10.8	References and further reading	179
11	Health and safety practices for health-care personnel and waste workers.....	181
11.1	Guiding principles	181
11.2	Occupational health risks	182
11.2.1	Health hazards	182
11.2.2	Cytotoxic safety.....	184
11.3	Exposure prevention and control	184
11.3.1	Hierarchy of controls (applied to bloodborne pathogens)	184
11.3.2	Dealing with spillages	185
11.3.3	Reporting accidents and incidents.....	187
11.3.4	Protective equipment	187
11.3.5	Occupational post-exposure prophylaxis.....	188
11.4	Training.....	189
11.5	Minimum approaches to health and safety practices	189
11.6	Desirable improvements to the minimum approach	189
11.7	References and further reading.....	190
12	Hospital hygiene and infection control	195
12.1	Guiding principles	195
12.2	Chain of infection	195
12.3	Epidemiology of nosocomial infections.....	195
12.3.1	Transition from exposure to infection.....	196
12.3.2	Sources of infection	197
12.3.3	Routes of transmission.....	197
12.4	Prevention of nosocomial infections	198
12.4.1	Standard precautions	198
12.4.2	Isolation of infected patients and standard precautions	200
12.4.3	Cleaning.....	200
12.4.4	Sterilization and disinfection.....	200
12.4.5	Hand hygiene.....	206
12.5	Measures for improving infection control	209
12.6	Minimum approach to hygiene and infection control.....	209
12.7	Desirable improvements to the minimum approach	210
12.8	References and further reading.....	210

13	Training, education and public awareness	213
13.1	Importance of training and education	213
13.2	Education and training of health-care personnel	214
13.2.1	Planning and implementation.....	214
13.2.2	Employees to be trained	216
13.2.3	Content of education programmes	216
13.2.4	Follow-up and refresher courses	217
13.2.5	Training responsibility	217
13.3	Implementation of a training course	217
13.3.1	The training package.....	217
13.3.2	Selection of participants.....	218
13.4	Training health-care waste handlers.....	219
13.4.1	Health-care personnel	219
13.4.2	Cleaning staff.....	219
13.4.3	Staff who transport waste	220
13.4.4	Treatment plant operators	221
13.4.5	Landfill operators	221
13.5	Integrating training with public education on risks of health-care waste	222
13.6	Minimum approach to training, education and public awareness.....	223
13.7	Desirable improvements to the minimum approach	223
13.7.1	Improvements to the minimum approach.....	223
13.7.2	Improvements to more advanced approaches	223
13.8	References and further reading	224
14	Health-care waste management in emergencies	225
14.1	Guiding principles	225
14.2	Phases for the safe management of health-care waste in emergencies	226
14.2.1	Phase one: rapid initial assessment	226
14.2.2	Phase two: emergency response	228
14.2.3	Phase three: recovery phase	233
14.3	Contingency planning and emergency preparedness	233
14.4	References and further reading	234
15	Future issues	237
15.1	Changing patterns of disease.....	237
15.1.1	Emerging diseases and multidrug-resistant organisms.....	237
15.1.2	Pandemics	237
15.2	Environmental issues.....	239
15.2.1	Climate change	239
15.2.2	Other environmental issues	240
15.3	Waste technology	241
15.4	Social, cultural and regulatory changes	242
15.5	References and further reading	243

Annex 1 Contributors to the first edition	245
Annex 2 Example training programmes in health-care waste management	247
Annex 3 Chemical destruction methods for cytostatic drugs.....	253
Annex 4 Clearance levels for radioactive waste.....	289
Annex 5 Accidental contamination by mutagenic and carcinogenic products.....	293
Annex 6 Disposal of pathological waste	297
Glossary	305

Tables

Table 2.1	Categories of health-care waste.....	4
Table 2.2	Chemical waste from health-care activities.....	7
Table 2.3	Examples of health-care waste from different sources	12
Table 2.4	Daily data-collection form.....	14
Table 2.5	Total and infectious waste generation by type of health-care facility (Pakistan, Tanzania, South Africa).....	17
Table 2.6	Total and infectious waste generation by type of health-care facility: high-income country (United States of America).....	18
Table 2.7	Bulk densities of health-care waste by components.....	18
Table 2.8	Average material composition of health-care waste	19
Table 2.9	Moisture content (%) of health-care waste components.....	19
Table 2.10	Heating value of health-care waste components.....	20
Table 3.1	Potential infections caused by exposure to health-care wastes, causative organisms and transmission vehicles.....	27
Table 3.2	Frequency of procedure that health-care workers were using at the moment of percutaneous injury, selected countries.....	32
Table 3.3	Viral hepatitis B infections caused by occupational injuries from sharps (USA).....	33
Table 5.1	Sample sheet for assessing waste generation.....	62
Table 7.1	WHO-recommended segregation scheme	79
Table 7.2	Advantages and disadvantages of needle cutters/destroyers	83
Table 7.3	Selected United Nations packaging symbols.....	97
Table 8.1	Typical reaction conditions and products from pyrolysis, gasification and incineration processes.....	118
Table 8.2	Emission guidelines for health-care waste incinerators	122
Table 10.1	Estimated capital and operating costs for available treatment methods.....	170
Table 10.2	Investment costs for incinerators in Indonesia	171
Table 10.3	Investment costs for incinerators in Africa.....	171
Table 10.4	Investment costs for large central incinerators that meet international standards.....	172
Table 10.5	Investment costs for alternative treatment solutions.....	172
Table 10.6	Positive and negative effects of fixed pricing.....	177
Table 10.7	Positive and negative effects of variable pricing.....	177
Table 11.1	Risk of transmission of infection following occupational exposure	182
Table 11.2	Hazards to health-care waste workers	183
Table 11.3	Example of a list of items for spillage cleaning	186
Table 12.2	The main forms of hand hygiene.....	206
Table 12.3	Ways to improve infection control.....	209
Table 14.1	Segregation of health-care waste in emergencies.....	229
Table 14.2	Summary of pharmaceutical disposal methods in and after emergencies.....	232
Table A2.1	Programme of the Certificate Programme in Health Care Waste Management.....	248
Table A2.2	Schedule for WHO-Euro's three-day course on health-care waste management	249
Table A2.3	Content of the UNEP health-care waste-management training modules.....	250

Table A3.1	Formulation of reconstituted and administration solutions of cytostatic drugs.....	282
Table A3.2	Efficiency of the degradation methods tested on 32 cytostatic drug formulations.....	286
Table A4.1	Generic clearance levels for solid waste.....	289
Table A4.2	Liquid discharge rates to sewers, rivers or other large water bodies.....	290
Table A4.3	Gaseous releases into the open air.....	291

Figures

Figure 2.1	Typical waste compositions in health-care facilities.....	3
Figure 2.2	Total and infectious waste generation in selected hospitals (kg per bed per day).....	15
Figure 2.3	Total and infectious waste generation in selected hospitals (kg per occupied bed per day or kg per patient per day).....	16
Figure 2.4	Total and infectious waste generation in small clinics, health centres and dispensaries (in kg per patient per day).....	16
Figure 5.1	Action plan for national programme of sound health-care waste management.....	54
Figure 5.2	Hospital waste-management structure.....	58
Figure 6.1	The waste-management hierarchy.....	67
Figure 7.1	Biohazard, radiation and chemical hazard symbols.....	79
Figure 7.2	Comparison of common hazardous waste symbols.....	80
Figure 7.3	Cardboard safety boxes.....	84
Figure 7.4	Example of a waste-segregation poster.....	85
Figure 7.5	Examples of interim waste storage places.....	87
Figure 7.6	Medical waste transport trolleys outside a hospital in Thailand.....	88
Figure 7.7	Example of a health care facility site plan with waste collection points (yellow circles).....	89
Figure 7.8	Example labels outside the storage facility.....	90
Figure 7.9	Example labels inside the storage facility.....	90
Figure 7.10	Label for a pathological waste storage room.....	91
Figure 7.11	Examples of storage places for chemical waste.....	93
Figure 7.12	Sketch of waste-storage area.....	94
Figure 7.14	Example of a vehicle used for transporting health-care waste in the United Kingdom.....	97
Figure 7.15	Specifications for placards (e.g. UN 3291 Infectious [Biomedical] Waste).....	99
Figure 7.16	Example of consignment note for carriage and disposal of infectious waste.....	100
Figure 7.17	Example of an emergency response intervention card.....	101
Figure 8.1	Simplified schematic of a pre-vacuum autoclave.....	109
Figure 8.2	Simplified schematic of batch and semicontinuous microwave technologies.....	113
Figure 8.3	Simplified flow scheme of the incineration process.....	117
Figure 8.4	Simplified schematic of a rotary kiln incinerator.....	120
Figure 8.5	Sample design of a concrete sharps vault.....	128
Figure 8.6	Routes of exposure to hazards caused by open dumping.....	134
Figure 8.7	Example of a low-cost pit cover.....	136
Figure 9.1	Deaths due to improper water and sanitation systems per 1000 population.....	148
Figure 9.2	Improper disposal of photochemicals into the sewerage system.....	152
Figure 9.3	Activated sludge wastewater-treatment system in a hospital in Sonla, Vietnam.....	154
Figure 9.4	Horizontal reed bed system.....	156
Figure 9.5	Basic hospital wastewater-treatment system with two treatment stages.....	159
Figure 9.6	Sample of a septic tank.....	160
Figure 9.7	Basic lagooning system at a hospital.....	162
Figure 11.1	Recommended protective clothing for health-care waste transportation in small hospitals in Thailand.....	188
Figure 12.1	The spread of nosocomial infections.....	199
Figure 12.2	Aide memoir for standard precautions in health care.....	204

Figure 12.3	Hand hygiene technique with alcohol-based formulation.....	207
Figure 12.4	Hand washing technique with soap and water.....	208
Figure 14.1	Construction of a pit for onsite waste burial.....	230
Figure 14.2	Special cells or trenches for disposal of biocontaminated wastes in a municipal dumping site (10 m long, 3 m wide and 2 m deep).....	231
Figure 14.3	Double-chamber incinerator in a health-care centre dumping site.....	231
Figure 15.1	Anticipated extension in the range of malaria in 2050.....	238
Figure A3.1	Schematic representation of procedure for destruction of doxorubicin or daunorubicin.....	256
Figure A3.2	Schematic representation of procedure for destruction of methotrexate or dichloromethotrexate using potassium permanganate/sulfuric acid.....	259
Figure A3.3	Schematic representation of procedure for destruction of methotrexate using aqueous alkaline potassium permanganate.....	261
Figure A3.4	Schematic representation of procedure for destruction of methotrexate using aqueous sodium hypochlorite.....	263
Figure A3.5	Schematic representation of procedure for destruction of cyclophosphamide and ifosfamide using alkaline hydrolysis in the presence of dimethylformamide.....	265
Figure A3.6	Schematic representation of procedure for destruction of cyclophosphamide using acid hydrolysis followed by addition of sodium thiosulfate and aqueous hydrolysis.....	268
Figure A3.7	Schematic representation of procedure for destruction of vincristine sulfate and vinblastine sulfate.....	271
Figure A3.8	Schematic representation of procedure for destruction of 6-thioguanine and 6-mercaptopurine.....	274
Figure A3.9	Schematic representation of procedure for destruction of cisplatin by reduction with zinc powder.....	276
Figure A3.10	Schematic representation of procedure for destruction of cisplatin by reaction with sodium diethyldithiocarbamate.....	278
Figure A3.11	Schematic representation of procedure for destruction of procarbazine using potassium permanganate in sulfuric acid.....	280
Figure A6.1	Example of a placenta pit.....	298
Figure A6.2	A dome biogester.....	301
Figure A6.3	A biogas plant.....	301

Boxes

Box 2.1	Common genotoxic products used in health care ^a	6
Box 2.2	Common recyclable materials from health-care facilities.....	9
Box 2.3	Major sources of health-care waste.....	9
Box 2.4	Minor sources of health-care waste.....	10
Box 3.1	Chain of infection.....	26
Box 3.2	Health sector contribution of mercury in the environment.....	29
Box 3.3	Cytotoxic drugs hazardous to eyes and skin.....	30
Box 3.4	Occupational transmission of HIV in France and the United States of America.....	33
Box 5.1	Parameters to be monitored by the waste-management officer.....	60
Box 5.2	Details to include in the waste-management plan.....	63
Box 6.1	Examples of practices that encourage waste minimization.....	68
Box 6.2	Reuse of medical devices in Canada.....	70
Box 6.3	Examples of sterilization methods for reusable items.....	71
Box 6.4	Recycling at the Heart of England NHS Foundation Trust.....	72
Box 6.5	Recycling infectious waste in Nepal.....	72
Box 6.6	Hospital food waste composting.....	73
Box 7.1	Recommendations for storage facilities for health-care waste.....	89
Box 7.2	Decay storage of radioactive waste – a sample calculation of decay storage time.....	94
Box 8.1	Characteristics of sodium hypochlorite (NaOCl) as a chemical disinfectant.....	115
Box 8.2	Essential elements for the design and operation of sanitary landfills.....	135

Box 10.1	Costs of construction and operation of a health-care waste-treatment plant (incinerator, autoclave, microwave, etc.)	169
Box 10.2	Tools for estimating total costs of health-care waste management	176
Box 11.1	Controls framework	185
Box 11.2	Example of general procedure for dealing with spillages.....	186
Box 12.1	Classification of pathogenic organisms.....	196
Box 13.1	Example of a training set-up.....	215
Box 13.2	Training tools examples (World Health Organization-related).....	218
Box 13.3	Training health-care personnel.....	219
Box 13.4	Training cleaning staff.....	220
Box 13.5	Training waste-transport staff.....	220
Box 13.6	Training treatment plant operators.....	221
Box 13.7	Issues to address when training treatment plant operators.....	222
Box 14.1	Rapid initial assessment.....	226
Box 14.2	Generic terms of reference for conducting a rapid initial assessment	227
Box 14.3	Issues to remember when collecting information in emergencies.....	227
Box 14.4	Key points to address during a recovery phase.....	233
Box 15.1	Key points relating to changing disease patterns.....	237
Box 15.2	Key points relating to climate change.....	239
Box 15.3	Key points relating to environmental issues.....	240
Box 15.4	Key points relating to waste technology	241
Box 15.5	Key points relating to social, cultural and regulatory changes	242

Foreword to the first edition

In pursuing their aims of reducing health problems and eliminating potential risks to people's health, health-care services inevitably create waste that may itself be hazardous to health. The waste produced in the course of health-care activities carries a higher potential for infection and injury than any other type of waste. Wherever waste is generated, safe and reliable methods for its handling are therefore essential.

Inadequate and inappropriate handling of health-care waste may have serious public health consequences and a significant impact on the environment. Sound management of health-care waste is thus a crucial component of environmental health protection.

In both the short term and the long term, the actions involved in implementing effective health-care waste management programmes require multisectoral cooperation and interaction at all levels. Policies should be generated and coordinated globally, with the management practices implemented locally. Establishment of a national policy and a legal framework, training of personnel, and raising public awareness are essential elements of successful health-care waste management.

Improved public awareness of the problem is vital in encouraging community participation in generating and implementing policies and programmes. Management of health-care waste should thus be put into a systematic, multifaceted framework, and should become an integral feature of health-care services.

To achieve this aim, the World Health Organization (WHO), together with WHO's European Centre for Environment and Health in Nancy, France, set up an international working group (in 1995) to produce a practical guide, addressing particularly the problems of health-care waste management in developing countries. The group included representatives of the private sector involved in waste management activities and members of the public.

This handbook, the result of their efforts, is intended to be comprehensive, yet concise, "user-friendly" and oriented towards practical management of health-care waste in local facilities. It provides guidelines for the responsible national and local administrators, and is the first publication to offer globally relevant advice on the management of health-care waste. The guidelines complement and supplement those produced in different regions in the past.

WHO strongly encourages the widespread implementation of these guidelines and is ready to assist users in adapting them to national settings. This handbook has been prepared as a practical response to the need for improved health-care waste management, especially in developing countries. Continuing efforts are being made to refine this response, and feedback from users of the handbook would be appreciated.

Comments and suggestions based on experience of this handbook's use may be sent to:

Department of Public Health, Environmental and Social Determinants of Health, World Health Organization, Geneva 27, CH-1211, Switzerland.

Acknowledgements

WHO wishes to express its appreciation to all whose efforts and valuable contributions made this production possible. In particular, WHO gratefully acknowledges the contributions of the following international experts who contributed to and reviewed the handbook.

Editorial

Yves Chartier, WHO, Switzerland
Jorge Emmanuel, UNDP GEF Global Healthcare Waste Project, United States of America
Ute Pieper, ETLog Health GmbH, Germany
Annette Prüss-Ustun, WHO, Switzerland
Philip Rushbrook, Foreign & Commonwealth Office, United Kingdom
Ruth Stringer, Health Care Without Harm, United Kingdom
William King Townend, International Environmental Consultancy, United Kingdom
Susan Wilburn, WHO, Switzerland
Raki Zghondi, WHO Regional Centre for Environmental Health Activities, Jordan

Authors

Ashok Agarwal, IGNOU, India
Franck Bouvet, UNICEF, Switzerland
Yves Chartier, WHO, Switzerland
Christopher Drew, Golder Consulting, United Kingdom
Jorge Emmanuel, UNDP GEF Global Healthcare Waste Project, United States of America
Ed Krisiunas, WNWN International, United States of America
Jan-Gerd Kühling, ETLog Health GmbH, Germany
Leo Leest, Management and Technical Solutions for Waste, the Netherlands
Ute Pieper, ETLog Health GmbH, Germany
Philip Rushbrook, Foreign & Commonwealth Office, London, United Kingdom
Ruth Stringer, Health Care Without Harm, United Kingdom
William King Townend, International Environmental Consultancy, United Kingdom
Andrew Trevett, UNICEF, United States of America
Susan Wilburn, WHO, Switzerland
Raki Zghondi, WHO Regional Centre for Environmental Health Activities, Jordan

Contributors

Ashok Agarwal, IGNOU, India
Franck Bouvet, UNICEF, Switzerland
Yves Chartier, WHO, Switzerland
Diego Daza, WHO, Colombia
Jorge Emmanuel, UNDP GEF Global Healthcare Waste Project, United States of America

Shinee Enkhsetseg, WHO, Germany
Ed Krisiunas, WNNW International, United States of America
Jan Gerd Kühling, ETLog Health GmbH, Germany
Leo Leest, Management and Technical Solutions for Waste, the Netherlands
Maria Mahon, GWB, United Kingdom
Victoria Masembe, JSI, Uganda
Nancy Muller, PATH, United States of America
Mahesh Nakarmi, Health Care Foundation Nepal, Nepal
Carib Nelson, PATH, United States of America
Ute Pieper, ETLog Health GmbH, Germany
Preethi Pratap, University of Illinois at Chicago School of Public Health, United States of America
Joanie Roberston, PATH, Vietnam
Marcia Rock, global health consultant, United States of America
Philip Rushbrook, Foreign & Commonwealth Office, London, United Kingdom
Dejana Selenic, CDC, United States of America
Ruth Stringer, Health Care Without Harm, United Kingdom
Ruma Tavorath, World Bank, India
William King Townend, International Environmental Consultancy, United Kingdom
Paul Williams, Consultant, United Kingdom
Anne Woolridge, Independent Safety Services Ltd, United Kingdom
Raki Zghondi, WHO Regional Centre for Environmental Health Activities, Jordan

WHO wishes to acknowledge gratefully the secretarial support of Lesley Robinson and Saydy Karbaj to the development of this volume.

WHO also gratefully acknowledges the experts who contributed to the first edition of this report (1999), whose names are listed in Annex 1.

The development of this second edition was made possible with the financial support and collaboration of the Bill & Melinda Gates Foundation, the International Solid Waste Association, the GAVI Alliance and the French Ministry of Social Affairs and Health.

In memoriam

The second edition of *Safe management of wastes from health-care activities* is dedicated to our distinguished colleague and dear friend **Yves Chartier (1958–2012)**, Public Health Engineer, who led the development of this work, and inspired involvement in and commitment to health-care waste management. Yves was the co-author of many WHO publications on environmental health in the health sector. This edition is also dedicated to our colleague **Carib Nelson (1956–2007)**, whose contributions consistently showed us a practical way through sound health-care waste management options.

Acronyms and abbreviations

ADR	<i>European agreement concerning the international carriage of dangerous goods by road</i>
AIDS	acquired immunodeficiency syndrome
AOX	absorbable organic iodinated compounds
ATSDR	United States Agency for Toxic Substances and Diseases Registry
BAT	best available techniques
BEP	best environmental practice
Blue Book	shortened title for this handbook, <i>Safe management of wastes from health-care activities</i>
CAT	cost-analysis tool
CDC	Centers for Disease Control and Prevention
CFU	colony forming unit
ClO ₂	chlorine dioxide
DEHP	diethylhexyl phthalate
DNA	deoxyribonucleic acid
ECAT	expanded cost-analysis tool
EMS	environmental management system
EPP	environmentally preferable purchasing
GEF	Global Environment Facility
HBV	hepatitis B virus
HCl	hydrochloric acid
HCV	hepatitis C virus
HEPA	high-efficiency particulate air
HIV	human immunodeficiency virus
H ₂ SO ₄	sulfuric acid
IARC	International Agency for Research on Cancer
IGNOU	Indira Gandhi National Open University
ILO	International Labour Organization
ISO	International Organization for Standardization
ISWA	International Solid Waste Association
MBR	membrane biological reactors
NaOCl	sodium hypochlorite
NGO	nongovernmental organization
NHS	National Health Service
PEP	post-exposure prophylaxis
PET	polyethylene terephthalate (also known as PETE)
POP	persistent organic pollutants
PPE	personal protective equipment
PVC	polyvinyl chloride
STAATT	State and Territorial Association on Alternate Treatment Technologies
TB	tuberculosis
UN	United Nations
UNDP	United Nations Development Programme

UNECE	United Nations Economic Commission for Europe
UNICEF	United Nations Children's Fund
UV	ultraviolet
WHO	World Health Organization

1

Introduction

This is the second edition of the World Health Organization (WHO) handbook on the safe, sustainable and affordable management of health-care waste – commonly known as “the Blue Book”. The original Blue Book was a comprehensive publication used widely in health-care centres and government agencies to assist in the adoption of national guidance. It also provided support to committed medical directors and managers to make improvements and presented practical information on waste-management techniques for medical staff and waste workers. The first edition in 1999 was published at an influential point in time. Public interest in emerging and developing countries to improve health services was growing, and poor waste practices within health-care facilities were being challenged increasingly by interest groups and communities. In the more developed countries, there was a renewed concern about consumption of resources and impacts on global changes to climate and the environment.

In many countries, knowledge about the potential for harm from health-care wastes has now become more prominent to governments, medical practitioners and civil society. Increasingly, managers and medical staff are expected to take more responsibility for the wastes they produce from their medical care and related activities. The indiscriminate and erratic handling and disposal of waste within health-care facilities is now widely recognized as a source of avoidable infection, and is synonymous with public perception of poor standards of health care.

It has been more than 10 years since the first edition of the Blue Book. During the intervening period, the requirements on generators of health-care wastes have evolved and new methods have become available. Consequently, WHO recognized that it was an appropriate time to update the original text. The purpose of the second edition is to expand and update the practical information in the original Blue Book. In June 2007, WHO held a workshop in Geneva with specialists from 31 countries. The specialists reviewed the Blue Book chapter by chapter and proposed new information to ensure the advice remains relevant to current demands on health-care facilities. During the following four years, every chapter was revised by authors from around the world. These authors gave their time voluntarily, and their drafts were extensively peer-reviewed before being edited into a final form.

The new Blue Book is designed to continue to be a source of impartial health-care information and guidance on safe waste-management practices. The editors’ intention has been to keep the best of the original publication and supplement it with the latest relevant information.

The audience for the Blue Book has expanded. Initially, the publication was intended for those directly involved in the creation and handling of health-care wastes: medical staff, health-care facility directors, ancillary health workers, infection-control officers and waste workers. This is no longer the situation. A wider range of people and organizations now have an active interest in the safe management of health-care wastes: regulators, policy-makers, development organizations, voluntary groups, environmental bodies, environmental health practitioners, advisers, researchers and students. They should also find the new Blue Book of benefit to their activities.

Chapters 2 and 3 explain the various types of waste produced from health-care facilities, their typical characteristics and the hazards these wastes pose to patients, staff and the general environment. Chapters 4 and 5 introduce the guiding regulatory principles for developing local or national approaches to tackling health-care waste management and transposing these into practical plans for regions and individual health-care facilities. Specific methods and technologies are described for waste minimisation, segregation and treatment of health-care wastes in Chapters 6, 7 and 8. These chapters introduce the basic features of each technology and the operational and environmental characteristics required to be achieved, followed by information on the potential advantages and disadvantages of each system.

To reflect concerns about the difficulties of handling health-care wastewaters, Chapter 9 is an expanded chapter with new guidance on the various sources of wastewater and wastewater treatment options for places not connected to central sewerage systems. Further chapters address issues on economics (Chapter 10), occupational safety (Chapter 11), hygiene and infection control (Chapter 12), and staff training and public awareness (Chapter 13).

A wider range of information has been incorporated into this edition of the Blue Book, with the addition of two new chapters on health-care waste management in emergencies (Chapter 14) and an overview of the emerging issues of pandemics, drug-resistant pathogens, climate change and technology advances in medical techniques that will have to be accommodated by health-care waste systems in the future (Chapter 15).

One further refinement has been a reformatting of most chapters to provide a more consistent appearance. Chapters begin with a list of basic questions to be answered and then describe the relevant concepts and techniques. They conclude with an outline of the minimum level of activity that should be present in a health-care facility, together with a summary of desirable improvements to this minimum. Finally, a list of the key points addressed in the chapter is provided as an aide memoire for readers.

Health-care waste will continue to be influenced by new social, economic and cultural circumstances. The revisions to the Blue Book ensure it remains an authoritative reference for the next decade, but work will not stop with this publication. WHO will continue to develop and improve its guidance, and welcome feedback.

The Editors

2

Definition and characterization of health-care waste

Key questions to answer

How is health-care waste defined and classified in national laws and regulations?

Which places in a health-care facility produce health-care waste?

Has a waste assessment of a health-care facility been conducted?

What are the composition, quantities and characteristics of health-care waste produced?

2.1 General definition and classification

The term health-care waste includes all the waste generated within health-care facilities, research centres and laboratories related to medical procedures. In addition, it includes the same types of waste originating from minor and scattered sources, including waste produced in the course of health care undertaken in the home (e.g. home dialysis, self-administration of insulin, recuperative care).

Between 75% and 90% of the waste produced by health-care providers is comparable to domestic waste and usually called “non-hazardous” or “general health-care waste”. It comes mostly from the administrative, kitchen and housekeeping functions at health-care facilities and may also include packaging waste and waste generated during maintenance of health-care buildings (Figure 2.1). The remaining 10–25% of health-care waste is regarded as “hazardous” and may pose a variety of environmental and health risks (see Chapter 3).

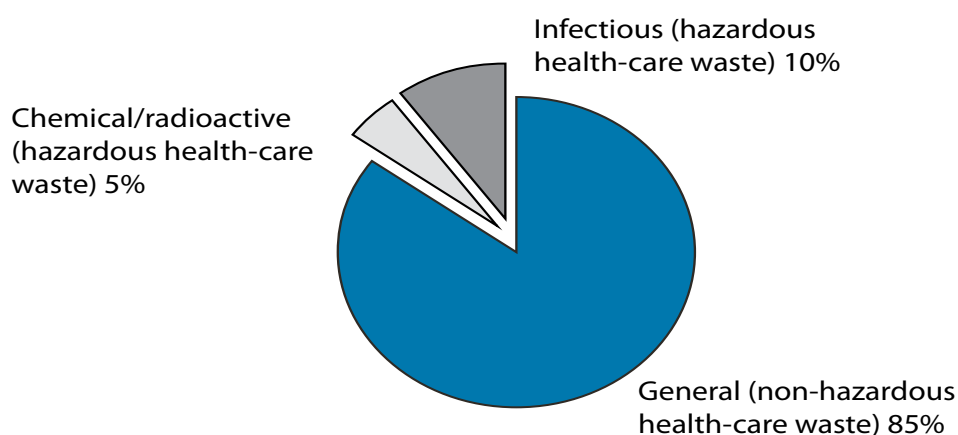

Figure 2.1 Typical waste compositions in health-care facilities

A classification of hazardous health-care waste is summarized in Table 2.1.

Table 2.1 Categories of health-care waste

Waste category	Descriptions and examples
Hazardous health-care waste	
Sharps waste	Used or unused sharps (e.g. hypodermic, intravenous or other needles; auto-disable syringes; syringes with attached needles; infusion sets; scalpels; pipettes; knives; blades; broken glass)
Infectious waste	Waste suspected to contain pathogens and that poses a risk of disease transmission (see section 2.1.2) (e.g. waste contaminated with blood and other body fluids; laboratory cultures and microbiological stocks; waste including excreta and other materials that have been in contact with patients infected with highly infectious diseases in isolation wards)
Pathological waste	Human tissues, organs or fluids; body parts; fetuses; unused blood products
Pharmaceutical waste, cytotoxic waste	Pharmaceuticals that are expired or no longer needed; items contaminated by or containing pharmaceuticals Cytotoxic waste containing substances with genotoxic properties (e.g. waste containing cytostatic drugs – often used in cancer therapy; genotoxic chemicals)
Chemical waste	Waste containing chemical substances (e.g. laboratory reagents; film developer; disinfectants that are expired or no longer needed; solvents; waste with high content of heavy metals, e.g. batteries; broken thermometers and blood-pressure gauges)
Radioactive waste	Waste containing radioactive substances (e.g. unused liquids from radiotherapy or laboratory research; contaminated glassware, packages or absorbent paper; urine and excreta from patients treated or tested with unsealed radionuclides; sealed sources)
Non-hazardous or general health-care waste	Waste that does not pose any particular biological, chemical, radioactive or physical hazard

2.1.1 Sharps waste

Sharps are items that could cause cuts or puncture wounds, including needles, hypodermic needles, scalpels and other blades, knives, infusion sets, saws, broken glass and pipettes. Whether or not they are infected, such items are usually considered highly hazardous health-care waste and should be treated as if they were potentially infected.

2.1.2 Infectious waste

Infectious waste is material suspected to contain pathogens (bacteria, viruses, parasites or fungi) in sufficient concentration or quantity to cause disease in susceptible hosts. This category includes:

- waste contaminated with blood or other body fluids
- cultures and stocks of infectious agents from laboratory work
- waste from infected patients in isolation wards.

Waste contaminated with blood or other body fluids include free-flowing blood, blood components and other body fluids; dressings, bandages, swabs, gloves, masks, gowns, drapes and other material contaminated with blood or other body fluids; and waste that has been in contact with the blood of patients undergoing haemodialysis (e.g. dialysis equipment such as tubing and filters, disposable towels, gowns, aprons, gloves and laboratory coats).

Laboratory cultures and stocks are highly infectious waste. Waste from autopsies, animal bodies, and other waste items that have been inoculated, infected, or in contact with highly infectious agents (based on the World Health Organization's [WHO] *Laboratory biosafety manual* (WHO, 2004) or other international or national risk-based classification of pathogens) are highly infectious waste. Discarded instruments or materials that have been in contact with persons or animals infected with highly infectious agents are also to be considered infectious waste.

Waste from infected patients in isolation wards includes excreta, dressings from infected or surgical wounds, and clothes heavily soiled with human blood or other body fluids. Waste from non-infective patients and that is not contaminated with blood or body fluids may be considered non-infectious. In low-resource settings, the infection-control or medical personnel should determine whether waste from non-isolation ward patients should be classified as infectious waste. They should apply the principles of the chain of infection (Chapter 3) to assess the risk of disease transmission from local practices used in the collection, handling, transport, treatment and disposal of waste.

2.2 Pathological waste

Pathological waste could be considered a subcategory of infectious waste, but is often classified separately – especially when special methods of handling, treatment and disposal are used. Pathological waste consists of tissues, organs, body parts, blood, body fluids and other waste from surgery and autopsies on patients with infectious diseases. It also includes human fetuses and infected animal carcasses. Recognizable human or animal body parts are sometimes called anatomical waste. Pathological waste may include healthy body parts that have been removed during a medical procedure or produced during medical research.

2.3 Pharmaceutical waste, including genotoxic waste

Pharmaceutical waste includes expired, unused, spilt and contaminated pharmaceutical products, prescribed and proprietary drugs, vaccines and sera that are no longer required, and, due to their chemical or biological nature, need to be disposed of carefully. The category also includes discarded items heavily contaminated during the handling of pharmaceuticals, such as bottles, vials and boxes containing pharmaceutical residues, gloves, masks and connecting tubing.

Genotoxic waste is highly hazardous and may have mutagenic (capable of inducing a genetic mutation), teratogenic (capable of causing defects in an embryo or fetus) or carcinogenic (cancer-causing) properties. The disposal of genotoxic waste raises serious safety problems, both inside hospitals and after disposal, and should be given special attention. Genotoxic waste may include certain cytostatic drugs (see below), vomit, urine or faeces from patients treated with cytostatic drugs, chemicals and radioactive material.

Technically, genotoxic means toxic to the deoxyribonucleic acid (DNA); cytotoxic means toxic to the cell; cytostatic means suppressing the growth and multiplication of the cell; antineoplastic means inhibiting the development of abnormal tissue growth; and chemotherapeutic means the use of chemicals for treatment, including cancer therapy.

Cytotoxic (chemotherapeutic or antineoplastic) drugs, the principal substances in this category, have the ability to kill or stop the growth of certain living cells and are used in chemotherapy of cancer. They play an important role in the therapy of various neoplastic conditions, but are also finding wider application as immunosuppressive agents in organ transplantation and in treating various diseases with an immunological basis. Cytotoxic drugs are most often used in specialized departments, such as oncology and radiotherapy units, whose main role is cancer treatment. Their use in other hospital departments and outside the hospital in clinics and elsewhere is also increasing.

Cytostatic drugs can be categorized as follows:

- alkylating agents: cause alkylation of DNA nucleotides, which leads to cross-linking and miscoding of the genetic stock;
- antimetabolites: inhibit the biosynthesis of nucleic acids in the cell;
- mitotic inhibitors: prevent cell replication.

Cytotoxic wastes are generated from several sources and can include the following:

- contaminated materials from drug preparation and administration, such as syringes, needles, gauzes, vials, packaging;
- outdated drugs, excess (leftover) solutions, drugs returned from the wards;
- urine, faeces and vomit from patients, which may contain potentially hazardous amounts of the administered cytostatic drugs or of their metabolites, and which should be considered genotoxic for at least 48 hours and sometimes up to 1 week after drug administration.

In specialized oncological hospitals, genotoxic waste (containing cytostatic or radioactive substances) may constitute as much as 1% of the total health-care wastes.

Common genotoxic substances, excluding radioactive substances, used in health care are listed in Box 2.1.

Box 2.1 Common genotoxic products used in health care^a

Classified as carcinogenic

Chemicals:

- benzene

Cytotoxic and other drugs:

- azathioprine, chlorambucil, chlornaphazine, ciclosporin, cyclophosphamide, melphalan, semustine, tamoxifen, thiotepa, treosulfan

Classified as possibly or probably carcinogenic

Cytotoxic and other drugs:

- azacitidine, bleomycin, carmustine, chloramphenicol, chlorozotocin, cisplatin, dacarbazine, daunorubicin, dihydroxymethylfuratrizine (e.g. Panfuran S – no longer in use), doxorubicin, lomustine, methylthiouracil, metronidazole, mitomycin, nafenopin, niridazole, oxazepam, phenacetin, phenobarbital, phenytoin, procarbazine hydrochloride, progesterone, sarcolysin, streptozocin, trichlormethine

^a Classified by working groups of the International Agency for Research on Cancer (IARC)

2.4 Chemical waste

Chemical waste consists of discarded solid, liquid and gaseous chemicals; for example, from diagnostic and experimental work and from cleaning and disinfecting procedures. Chemical waste from health care is considered to be hazardous if it has at least one of the following properties. More details on the nature of these risks are presented in Chapter 3:

- toxic (harmful)
- corrosive (e.g. acids of pH <2 and bases of pH >12)
- flammable
- reactive (explosive, water reactive, shock sensitive)
- oxidizing.

Non-hazardous chemical waste consists of chemicals with none of the above properties; for example, sugars, amino acids and certain organic and inorganic salts, which are widely used in transfusion liquids.

The most common types of hazardous chemicals used in health-care centres and hospitals, and the most likely to be found in waste, are described in the following paragraphs.

Formaldehyde is a significant source of chemical waste in hospitals. It is used to clean and disinfect equipment (e.g. haemodialysis or surgical equipment); to preserve specimens; to disinfect liquid infectious waste; and in pathology, autopsy, dialysis, embalming and nursing units.

Photographic fixing and developing solutions are used in X-ray departments where photographic film continues to be used. The fixer usually contains 5–10% hydroquinone, 15% potassium hydroxide and less than 1% silver. The developer contains approximately 45% glutaraldehyde. Acetic acid is used in both “stop” baths and fixer solutions.

Wastes containing solvents are generated in various departments of a hospital, including pathology and histology laboratories and engineering departments. Solvents include halogenated and non-halogenated compounds. Waste organic chemicals generated in health-care facilities include disinfecting and cleaning solutions, vacuum-pump and engine oils, insecticides and rodenticides. Waste inorganic chemicals consist mainly of acids and alkalis, oxidants and reducing agents.

Wastes from materials with high heavy-metal contents represent a subcategory of hazardous chemical waste and are usually highly toxic. Mercury is an example of a highly toxic yet common substance in health-care facilities. Mercury wastes are typically generated by spillage from broken clinical equipment, but their volume is decreasing in many countries with the substitution of mercury-free instruments (e.g. digital thermometers, aneroid blood-pressure gauges). Whenever possible, spilt drops of mercury should be recovered. Residues from dentistry also have high mercury contents. Cadmium waste comes mainly from discarded batteries. Reinforced wood panels containing lead are still used in radiation proofing in X-ray and diagnostic departments.

Many types of gas are used in health care and are often stored in portable pressurized cylinders, cartridges and aerosol cans. Many of these are reusable, once empty or of no further use (although they may still contain residues). However, certain types – notably aerosol cans – are single-use containers that require disposal. Whether inert or potentially harmful, gases in pressurized containers should always be handled with care; containers may explode if incinerated or accidentally punctured.

Table 2.2 lists the general classes of chemical waste found in health-care facilities.

Table 2.2 Chemical waste from health-care activities

Chemical waste	Examples
Halogenated solvents	Chloroform, methylene chloride, perchloroethylene, refrigerants, trichloroethylene
Non-halogenated solvents	Acetone, acetonitrile, ethanol, ethyl acetate, formaldehyde, isopropanol, methanol, toluene, xylenes
Halogenated disinfectants	Calcium hypochlorite, chlorine dioxide, iodine solutions, iodophors, sodium dichloroisocyanurate, sodium hypochlorite (bleach)
Aldehydes	Formaldehyde, glutaraldehydes, ortho-phthalaldehyde
Alcohols	Ethanol, isopropanol, phenols
Other disinfectants	Hydrogen peroxide, peroxyacetic acid, quarternary amines
Metals	Arsenic, cadmium, chromium, lead, mercury, silver
Acids	Acetic, chromic, hydrochloric, nitric, sulfuric
Bases	Ammonium hydroxide, potassium hydroxide, sodium hydroxide
Oxidizers	Bleach, hydrogen peroxide, potassium dichromate, potassium permanganate
Reducers	Sodium bisulfite, sodium sulfite
Miscellaneous	Anaesthetic gases, asbestos, ethylene oxide, herbicides, paints, pesticides, waste oils

2.5 Radioactive waste

Radioactive wastes are materials contaminated with radionuclides. They are produced as a result of procedures such as in vitro analysis of body tissue and fluid, in vivo organ imaging and tumour localization, and various investigative and therapeutic practices.

Radionuclides used in health care are in either unsealed (or open) sources or sealed sources. Unsealed sources are usually liquids that are applied directly, while sealed sources are radioactive substances contained in parts of equipment or encapsulated in unbreakable or impervious objects, such as pins, “seeds” or needles.

Radioactive health-care waste often contains radionuclides with short half-lives (i.e. half of the radionuclide content decays in hours or a few days); consequently, the waste loses its radioactivity relatively quickly. However, certain specialized therapeutic procedures use radionuclides with longer half-lives; these are usually in the form of small objects placed on or in the body and may be reused on other patients after sterilization. Waste in the form of sealed sources may have a relatively high radioactivity, but is only generated in low volumes from larger medical and research laboratories. Sealed sources are generally returned to the supplier and should not enter the waste stream.

The waste produced by health-care and research activities involving radionuclides and related equipment maintenance and storage can be classified as follows:

- sealed sources;
- spent radionuclide generators;
- low-level solid waste (e.g. absorbent paper, swabs, glassware, syringes, vials);
- residues from shipments of radioactive material and unwanted solutions of radionuclides intended for diagnostic or therapeutic use;
- liquid immiscible with water, such as liquid scintillation counting;
- residues used in radioimmunoassay, and contaminated pump oil;
- waste from spills and from decontamination of radioactive spills;
- excreta from patients treated or tested with unsealed radionuclides;
- low-level liquid waste (e.g. from washing apparatus);
- gases and exhausts from stores and fume cupboards.

2.6 Non-hazardous general waste

Non-hazardous or general waste is waste that has not been in contact with infectious agents, hazardous chemicals or radioactive substances and does not pose a sharps hazard. A significant proportion (about 85%) of all waste from health-care facilities is non-hazardous waste and is usually similar in characteristics to municipal solid waste. More than half of all non-hazardous waste from hospitals is paper, cardboard and plastics, while the rest comprises discarded food, metal, glass, textiles, plastics and wood.

In many places, community or regulatory requirements encourage materials recycling. In the past, all or most non-hazardous and municipal waste was discarded in dumps or landfills or burnt in municipal incinerators. Greater awareness of the environmental impacts of waste and the recognition that most of the non-hazardous waste from health-care facilities is potentially recyclable or compostable have changed the approaches to managing general waste (see Chapter 6).

Box 2.2 lists examples of common recyclable materials found in health-care facilities.

Box 2.2 Common recyclable materials from health-care facilities

Corrugated cardboard boxes
Newspapers and magazines
Polyethylene terephthalate (PET or PETE) (e.g. plastic water bottles, soft-drink bottles)
Polystyrene packaging
Wood (e.g. shipping pallets)
Paper (e.g. white office paper, computer printer paper, coloured ledger paper)
Metals (e.g. aluminium beverage cans and containers, food tin cans, other metal containers)
High-density polyethylene (HDPE) (e.g. plastic milk containers, containers for food, plastic bottles for saline solutions or sterile irrigation fluids)
Clear, coloured or mixed glass
Construction and demolition debris

In addition, durable goods such as used furniture, bed frames, carpets, curtains and dishware, as well as computer equipment, printer cartridges and photocopying toners, are also potentially reusable. Flowers, food waste from kitchen services and plant waste from grounds maintenance are examples of compostable waste.

2.7 Sources of health-care waste

Different types of health-care facilities can be viewed as major or minor sources of health-care waste, according to the quantities produced. The major sources are listed in Box 2.3.

Box 2.3 Major sources of health-care waste

Hospitals

University hospital
General hospital
District hospital

Other health-care facilities

Emergency medical care services
Health-care centres and dispensaries
Obstetric and maternity clinics
Outpatient clinics
Dialysis centres
Long-term health-care establishments and hospices
Transfusion centres
Military medical services
Prison hospitals or clinics

Related laboratories and research centres

Medical and biomedical laboratories
Biotechnology laboratories and institutions
Medical research centres

Mortuary and autopsy centres

Animal research and testing

Blood banks and blood collection services

Nursing homes for the elderly

Minor and scattered sources produce some health-care waste, but their quantities and composition will vary. These sources typically have some common features:

- They rarely produce radioactive or cytostatic waste.
- Human body parts are not normally produced.
- Sharps consist mainly of hypodermic needles.

Box 2.4 lists some minor sources of health-care waste. However, it should be recognized that the quantities of waste from the home treatment of medical conditions and long-term home-based care are rising significantly in many countries.

Box 2.4 Minor sources of health-care waste

Small health-care establishments

First-aid posts and sick bays

Physicians' offices

Dental clinics

Acupuncturists

Chiropractors

Specialized health-care establishments and institutions with low waste generation

Convalescent nursing homes

Psychiatric hospitals

Disabled persons' institutions

Activities involving intravenous or subcutaneous interventions

Cosmetic ear-piercing and tattoo parlours

Illicit drug users and needle exchanges

Funeral services

Ambulance services

Home treatment

The general composition of wastes is often characteristic of the type of medical facility and its health-care activities (see Table 2.3).

In the absence of clear laws and guidelines, determining the proper classification of specific waste items should be based on an understanding of the principles of disease transmission and hazardous chemical exposure. The infection-control officer at larger health-care facilities plays an important role in this process. An item should be considered an infectious waste if there is the likelihood that disease transmission can occur during the handling and disposal of the item in question. For disease transmission to occur, the chain of infection requires the presence of pathogens of sufficient virulence and dose, a mode of transmission (e.g. spills or breakage of containers, resulting in skin contact or airborne transmission), a portal of entry (such as an open wound, inhalation or exposure through the mucous membranes) and a susceptible host (e.g. cleaner, waste worker, scavenger at an open dump site). Some countries with strong occupational safety programmes and well-designed systems for collection, transportation and disposal may not consider certain items (e.g. waste with dried blood) as infectious waste; however, in other countries, those same items may have to be treated as infectious waste if proper waste containers are not available, waste workers have no personal protection or waste is discarded in open dump sites that are accessible to the public.

2.8 Generation of health-care waste

Knowing the types and quantities of waste produced in a health-care facility is an important first step in safe disposal. Waste-generation data are used in estimating the required capacities for containers, storage areas, transportation and treatment technologies. Waste-generation data can be used to establish baseline data on rates of production in different medical areas and for procurement specifications, planning, budgeting, calculating revenues from recycling, optimization of waste-management systems, and environmental impact assessments.

Health-care waste-generation data are best obtained from quantitative waste assessments. An assessment entails defining goals, planning, enlisting the cooperation of staff, procurement of equipment (e.g. weighing scales, personal protective equipment), data collection, analysis and recommendations. The process of waste assessment provides an opportunity to improve current practices, sensitize health workers about waste, and determine the potential for waste minimization. Implementing rigorous segregation can avoid over-sizing of equipment and result in cost savings.

The design of a waste-assessment programme can vary. Generally, data are collected regularly (typically daily) from each area of a facility, waste items are segregated into separate containers, each container is weighed and the weights produced are compared against the number of patients or beds in use. Data collection for a period of a few days provides limited information and may not accurately reflect weekly or seasonal variations. Data collection for a month or longer and repeated at different times in the year provides a more accurate picture and a better understanding of the quantities of waste generated in individual parts of a facility. For waste minimization, a breakdown of the amounts of recyclable materials is needed. In addition to calculating average rates, information regarding the spread of the data (data range or standard deviation) is important. An example of a data-collection form is given in Table 2.4. Instructions to data collectors should include worker safety, such as using personal protective equipment and avoiding physical contact with infectious items.

Table 2.3 Examples of health-care waste from different sources

Major sources (hospitals and medical centres)				
	Sharps	Infectious and pathological waste	Chemical, pharmaceutical and cytotoxic waste	Non-hazardous or general waste
Medical ward	Hypodermic needles, intravenous set needles, broken vials and ampoules	Dressings, bandages, gauze and cotton contaminated with blood or body fluids; gloves and masks contaminated with blood or body fluids	Broken thermometers and blood-pressure gauges, spilt medicines, spent disinfectants	Packaging, food scraps, paper, flowers, empty saline bottles, non-bloody diapers, non-bloody intravenous tubing and bags
Operating theatre	Needles, intravenous sets, scalpels, blades, saws	Blood and other body fluids; suction canisters; gowns, gloves, masks, gauze and other waste contaminated with blood and body fluids; tissues, organs, fetuses, body parts	Spent disinfectants Waste anaesthetic gases	Packaging; uncontaminated gowns, gloves, masks, hats and shoe covers
Laboratory	Needles, broken glass, Petri dishes, slides and cover slips, broken pipettes	Blood and body fluids, microbiological cultures and stocks, tissue, infected animal carcasses, tubes and containers contaminated with blood or body fluids	Fixatives; formalin; xylene, toluene, methanol, methylene chloride and other solvents; broken lab thermometers	Packaging, paper, plastic containers
Pharmacy store			Expired drugs, spilt drugs	Packaging, paper, empty containers
Radiology			Silver, fixing and developing solutions; acetic acid; glutaraldehyde	Packaging, paper
Chemotherapy	Needles and syringes		Bulk chemotherapeutic waste; vials, gloves and other material contaminated with cytotoxic agents; contaminated excreta and urine	Packaging, paper
Vaccination campaigns	Needles and syringes		Bulk vaccine waste, vials, gloves	Packaging
Environmental services	Broken glass		Disinfectants (glutaraldehyde, phenols, etc.), cleaners, spilt mercury, pesticides	Packaging, flowers, newspapers, magazines, cardboard, plastic and glass containers, yard and plant waste
Engineering			Cleaning solvents, oils, lubricants, thinners, asbestos, broken mercury devices, batteries	Packaging, construction or demolition waste, wood, metal
Food services				Food scraps; plastic, metal and glass containers; packaging

Table 2.3 *continued*

Minor sources				
	Sharps	Infectious and pathological waste	Chemical, pharmaceutical and cytotoxic waste	Non-hazardous or general waste
Physicians' offices	Needles and syringes, broken ampoules and vials	Cotton, gauze, dressings, gloves, masks and other materials contaminated with blood or other body fluids	Broken thermometers and blood-pressure gauges, expired drugs, spent disinfectants	Packaging, office paper, newspapers, magazines, uncontaminated gloves and masks
Dental offices	Needles and syringes, broken ampoules	Cotton, gauze, gloves, masks and other materials contaminated with blood and other body fluids	Dental amalgam, spent disinfectants	Packaging, office paper, newspapers, magazines, uncontaminated gloves and masks
Home health care	Lancets and insulin injection needles	Bandages and other material contaminated with blood or other body fluids	Broken thermometers	Domestic waste

Table 2.4 Daily data-collection form

Date _____
 Name of data collector _____
 Name of health facility _____
 Number of occupied beds _____
 Number of outpatients _____

Department	Type of waste ^a	Weight (kg)	Volume (litre)	Notes ^b

^a The type of waste should be consistent with the classifications used in the country (e.g. sharps, infectious, pathological/anatomical, chemical, pharmaceutical, radioactive or general [non-hazardous] waste). General waste may be broken down further according to types of recyclable materials.
^b Improper segregation practices, descriptions of containers in use, the level of fill of sharps containers or waste bags, and accidental spills should be noted.

If a quantitative waste assessment is not possible, other commonly used methods include a survey questionnaire asking staff to estimate waste quantities, or observations and interviews with staff. When extrapolating data from measurements at individual facilities or from survey questionnaires, consideration should be given to sampling size and the selection of representative facilities.

Many factors affect the rate of waste generation, including:

- level of activity (often measured in terms of the number of occupied beds, number of patients per day, and/or number of staff);
- type of department (e.g. general ward, surgical theatre, office);
- type or level of facility (e.g. clinic, provincial hospital);
- location (rural or urban);
- regulations or policies on waste classification;
- segregation practices;
- temporal variations (e.g. weekday versus weekend, seasonal);
- level of infrastructure development of the country.

Variations in waste generation according to the type or level of health-care facility, or between rural and urban health-care facilities, may reflect differences in services provided, scale, organizational complexity, availability of resources and the number of medical and other staff. Regulations or policies on waste classification as well as segregation practices affect the breakdown of waste-generation rates. Dissimilarities among low-, middle- and high-income countries may be partly due to differences in resources, services provided, available waste-management systems and the proportion of single-use disposable items.

Average waste generation rates are calculated in kilograms (kg) per day or kg per year. Kilograms per occupied bed per day, and kg per patient per day, are used especially when comparing different health-care facilities with different levels of activities. If inpatient occupancy rates and the daily number of outpatients are not available,

the total number of beds is often used to estimate kg per bed per day. For analysing departments within a health system, Tudor (2007) suggests using kg per person per month (where “person” refers to both patients and staff) as a more accurate and stable measure of activity, and as a tool to identify departments that could benefit from waste reduction, reuse and recycling.

Waste-generation data from other countries must be used with caution because of the wide variability even within a country and the many factors that influence the rates. The data in Figures 2.2 to 2.4, and in Tables 2.5 and 2.6, are provided as indicative values and should be viewed only as examples. They may be useful for order-of-magnitude estimations, but should not be used for detailed planning, budgeting or procurement. Even a limited survey will probably provide more reliable data on local waste generation than any estimate based on data from other countries or types of establishment.

2.9 Physicochemical characteristics

One aspect of a waste assessment is the characterization of the physicochemical composition of health-care waste. This information is essential in developing waste-minimization plans. Setting up an efficient recycling programme requires an understanding of the composition of general (non-hazardous) waste. Physicochemical parameters of the infectious portion of the waste stream are useful in establishing equipment specifications or operating parameters for treatment technologies. For example, some steam and microwave treatment systems rely on a minimum amount of moisture to be present in waste; some chemical systems are affected by the organic load and water content; and incineration is influenced by the percentage of incombustibles (ash), heating (calorific) value and moisture content of waste.

Physical properties, such as bulk density (uncompacted mass per unit volume), are used to estimate storage, transport and treatment chamber capacities, as well as specifications for compactors, shredders and other size-reduction equipment. Common to any waste classification, the physicochemical characteristics of health-care waste will vary from country to country and between health-care facilities within a country.

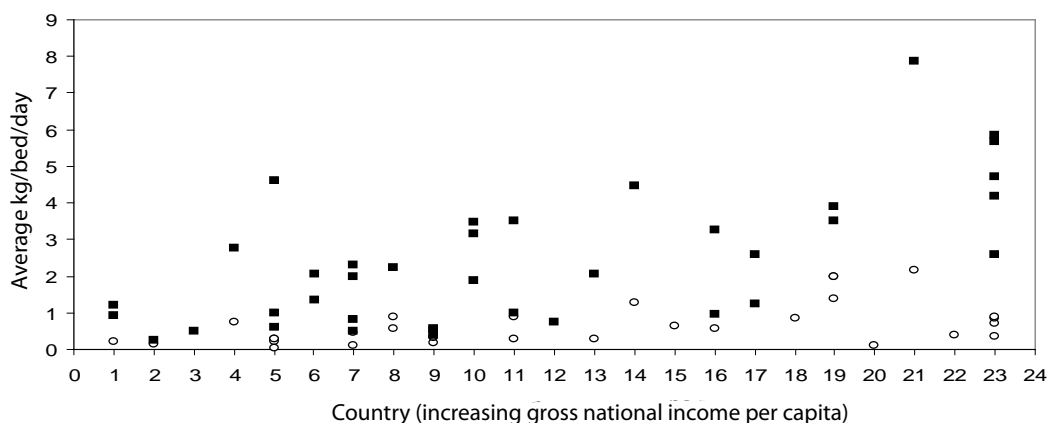

■ = total health-care waste; ○ = infectious waste; points represent averages; vertical columns are ranges of data
 1-Bangladesh (includes clinics), 2-Cambodia, 3-Lao PDR, 4-Nigeria, 5-Vietnam, 6-Pakistan, 7-India, 8-Guyana, 9-Philippines, 10-Jordan, 11-Colombia, 12-Peru, 13-Thailand, 14-Iran, 15-Bulgaria, 16-Brazil (includes health centres and laboratories), 17-Turkey; 18-Taiwan (China), 19-Portugal, 20-Hong Kong (China), 21-Kuwait, 22-Italy, 23-United States of America
 Source: Emmanuel (2007)

Figure 2.2 Total and infectious waste generation in selected hospitals (kg per bed per day)

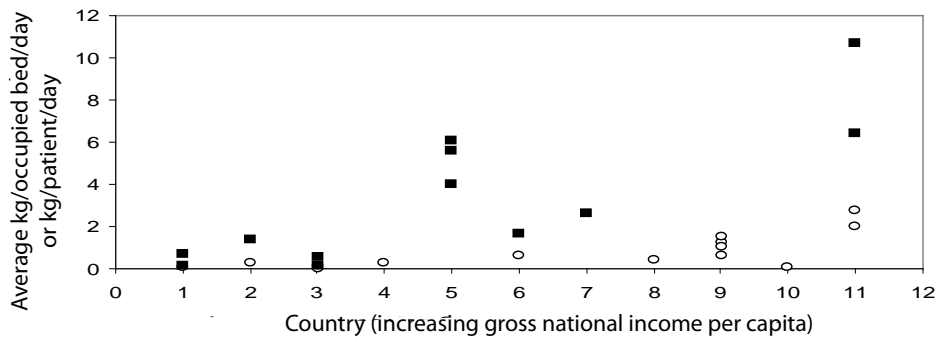

■ = total health-care waste; ○ = infectious waste

1-Tanzania, 2-Vietnam, 3-Mongolia, 4-Bhutan, 5-Jordan, 6-Ecuador, 7-Peru, 8-Bulgaria, 9-South Africa, 10-Mauritius, 11-United States of America

Source: Emmanuel (2007)

Figure 2.3 Total and infectious waste generation in selected hospitals (kg per occupied bed per day or kg per patient per day)

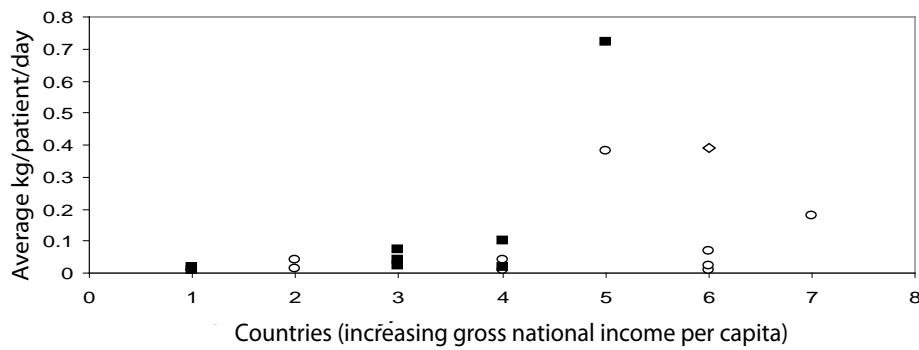

■ = total health-care waste; ○ = infectious waste

1-Tanzania, 2-Bangladesh, 3-Pakistan, 4-Mongolia, 5-Ecuador, 6-South Africa, 7-Mauritius

Source: Emmanuel (2007)

Figure 2.4 Total and infectious waste generation in small clinics, health centres and dispensaries (in kg per patient per day)

Table 2.5 Total and infectious waste generation by type of health-care facility (Pakistan, Tanzania, South Africa)

Type of health-care facility	Total health-care waste generation	Infectious waste generation
Pakistan		
Hospitals	2.07 kg/bed/day (range: 1.28–3.47)	
Clinics and dispensaries	0.075 kg/patient-day	0.06 kg/patient-day
Basic health units	0.04 kg/patient-day	0.03 kg/patient-day
Consulting clinics	0.025 kg/patient-day	0.002 kg/patient-day
Nursing homes	0.3 kg/patient-day	
Maternity homes	4.1 kg/patient-day	2.9 kg/patient-day
Tanzania		
Hospitals	0.14 kg/patient-day	0.08 kg/patient-day
Health centres (urban)	0.01 kg/patient-day	0.007 kg/patient-day
Rural dispensaries	0.04 kg/patient-day	0.02 kg/patient-day
Urban dispensaries	0.02 kg/patient-day	0.01 kg/patient-day
South Africa		
National central hospital		1.24 kg/patient-bed/day
Provincial tertiary hospital		1.53 kg/patient-bed/day
Regional hospital		1.05 kg/patient-bed/day
District hospital		0.65 kg/patient-bed/day
Specialized hospital		0.17 kg/patient-bed/day
Public clinic		0.008 kg/patient-day
Public community health centre		0.024 kg/patient-day
Private day-surgery clinic		0.39 kg/patient-day
Private community health centre		0.07 kg/patient-day

Sources: Pakistan data from four hospitals and other facilities in Karachi; Pescod Et Saw (1998). Tanzania data based on a survey of facilities in Dar es Salaam; Christen (1996), used with permission. South Africa data from a survey of 13 hospitals and 39 clinics in Gauteng and Kwa Zulu Natal; clinics have no beds and may not be open all week; community health centres have up to 30 beds and operate 7 days a week; DEAT (2006)

Table 2.6 Total and infectious waste generation by type of health-care facility: high-income country (United States of America)

Type of health-care facility	Total health-care waste generation	Infectious waste generation
Metropolitan general hospitals	10.7 kg/occupied bed/day	2.79 kg/occupied bed/day
Rural general hospitals	6.40 kg/occupied bed/day	2.03 kg/occupied bed/day
Psychiatric and other hospitals	1.83 kg/occupied bed/day	0.043 kg/occupied bed/day
Nursing homes	0.90 kg/occupied bed/day	0.038 kg/occupied bed/day
Laboratories	7.7 kg/day	1.9 kg/day
Doctor's office (group practice, urban)	1.78 kg/physician-day	0.67 kg/physician-day
Doctor's office (individual, urban)	1.98 kg/physician-day	0.23 kg/physician-day
Doctor's office (rural)	0.93 kg/physician-day	0.077 kg/physician-day
Dentist's office (group practice)	1.75 kg/dentist-day	0.13 kg/dentist-day
Dentist's office (individual)	1.10 kg/dentist-day	0.17 kg/dentist-day
Dentist's office (rural)	1.69 kg/dentist-day	0.12 kg/dentist-day
Veterinarian (group practice, metropolitan)	4.5 kg/veterinarian-day	0.66 kg/veterinarian-day
Veterinarian (individual, metropolitan)	0.65 kg/veterinarian-day	0.097 kg/veterinarian-day
Veterinarian (rural)	7.7 kg/veterinarian-day	1.9 kg/veterinarian-day

Source: Survey of 37 hospitals, 41 nursing homes, 20 laboratories, 8 funeral homes, 41 doctors' offices, 64 dentists' offices and 17 veterinarians in Florida, United States of America; Sengupta (1990)

Different average bulk densities for health-care waste have been reported in the literature: 594 kg/m³ (urban hospitals, Tanzania; Mata & Kaseva, 1999); 218 kg/m³ for total waste, 211 kg/m³ for general waste and 226 kg/m³ for contaminated waste (hospitals, Peru; Diaz et al., 2008); 151 kg/m³ for general waste and 262 kg/m³ for contaminated waste (urban hospitals, Philippines; Pescod & Saw, 1998); and 110 kg/m³ including boxes and 100 kg/m³ without boxes (large hospital, Italy; Liberti et al., 1994). More detail on the bulk densities for different components of health-care waste found in Ecuador and Canada is given in Table 2.7.

Table 2.7 Bulk densities of health-care waste by components

Canada		Ecuador	
Component	kg/m ³	Component	kg/m ³
Human anatomical	800–1200	General wastes	596
Plastics	80–2300	Kitchen wastes	322
Swabs, absorbents	80–1000	Yard wastes	126
Alcohol, disinfectants	800–1000	Paper/cardboard	65
Animal infected anatomical	500–1300	Plastic/rubber	85
Glass	2800–3600	Textiles	120
Bedding, shavings, paper, faecal matter	320–730	Sharps	429
Gauze, pads, swabs, garments, paper, cellulose	80–1000	Food wastes	580
Plastics, polyvinyl chloride (PVC), syringes	80–2300	Medicines	959
Sharps, needles	7200–8000		
Fluid, residuals	990–1010		

Sources: Ontario Ministry of the Environment (1986); Diaz et al. (2008)

Determination of the material composition of general waste is important when setting up recycling programmes. Table 2.8 shows the average material compositions of health-care waste from hospitals in different countries.

Table 2.8 Average material composition of health-care waste

Jordan ^a		Peru		Turkey		Taiwan (China)		Kuwait		Italy	
Component	%	Component	%	Component	%	Component	%	Component	%	Component	%
Paper	38	Mixed paper	22	Paper	16	Paper	34	Paper	24	Paper	34
		Cardboard	5	Cardboard	5			Cardboard	8		
Plastic	27	Plastic	12	Plastic	41	Plastic	26	Plastic	18	Plastics	46
Glass	10	Glass	8	Glass	7	Glass	7	Glass	10	Glass	8
Metals	5			Metal	2	Metal	4	Metal	9	Metal	0.4
				Food	17	Food	15	Food	12		
Textiles	11	Cotton/ gauze	18	Textiles	10	Textiles	9	Textiles	11		
		Placenta	8							Anatomical	0.1
Garbage	9	Other	27	Other	3	Other	3	Other	8	Liquids	12

^a Kitchen waste excluded

Sources: Jordan data based on a 224-bed hospital; Awad, Obeidat & Al-Shareef (2005). Peru data based on an average of 6 hospitals; Ministerio de Salud (1995). Turkey data based on 4 hospitals; Altin et al. (2003). Taiwan (China) data based on an average of 3 hospitals; Chih-Shan & Fu-Tien (1993). Kuwait data from 2 hospitals; Hamoda, El-Tomi & Bahman (2005). Italy data based on 120 samples from a 1900-bed hospital; Liberti et al. (1994)

The moisture content of different components of overall health-care waste and infectious waste is shown in Table 2.9. Wide differences are noted. Health-care waste from a 1900-bed hospital in Italy had an average moisture level of 26.76%, with a standard deviation of 8.48%, based on 409 samples (Liberti et al., 1994). Some departments, such as obstetrics, paediatrics and dialysis, had moisture levels as high as 50%. Lower moisture content was found in the waste from four hospitals in Turkey. They had an average moisture content of 14.15%. In addition, these hospitals had an average percentage of incombustibles of about 8% (Altin et al., 2003).

Table 2.9 Moisture content (%) of health-care waste components

Overall health-care waste (%)					Infectious waste (%)	
Component	Ecuador	Component	Jordan	Turkey	Component	Canada
Paper/cardboard	16	Paper	22–57	4.5	Human anatomical	70–90
Food	45	Food		63	Plastics	0–1
Textile	30	Textile	37–68	8.6	Swabs, absorbents	0–30
Plastic/rubber	15	Plastic	11–54	2.8	Alcohol, disinfectants	0–0.2
Kitchen waste	47	Garbage	37–57		Animal-infected anatomical	60–90
Garden wastes	40	Carton		5	Glass	0
Medicines	64	Metal		2.25	Bedding, shavings, paper, faecal matter	10–50
		Glass		2.05	Gauze, pads, swabs, garments, paper, cellulose	0–30
		Other		8	Plastics, polyvinyl chloride, syringes	0–1
					Sharps, needles	0–1
					Fluid, residuals	80–100

Sources: Diaz et al. (2008); Awad, Obeidat & Al-Shareef (2005); Altin et al. (2003); Ontario Ministry of the Environment (1986)

The percentages of residues from infectious hospital waste, based on 409 samples from a hospital in Italy, were 66% at 110 °C, 15% at 550 °C, and 14% at 1000 °C. A low heating value of wet hazardous health-care waste was measured at 3500 kcal/kg (14.65 MJ/kg). The ranges of heating values for different components of health-care waste are provided in Table 2.10.

Table 2.10 Heating value of health-care waste components

Component	Heating value (as fired)	
	MJ/kg	kcal/kg
Human anatomical	2–8.4	400–2000
Plastics	32–46	7700–11000
Swabs, absorbents	13–28	3100–6700
Alcohol, disinfectants	25–32	6100–7800
Animal infected anatomical	2–15	500–3600
Glass	0	0
Bedding, shavings, paper, faecal matter	9–19	2200–4500
Gauze, pads, swabs, garments, paper, cellulose	13–28	3100–6700
Sharps, needles	0–0.1	0–30
Fluid, residuals	0–5	0–1100

Source: Based on Milburn (1990)

The approximate chemical composition of hospital waste is 37% carbon, 18% oxygen and 4.6% hydrogen, as well as numerous other elements (Liberti et al., 1994). The toxic metals that are found in health-care waste and that are readily emitted during combustion include lead, mercury, cadmium, arsenic, chromium and zinc. In the past, elemental compositions were used to estimate the products of combustion, but this can be misleading since health-care waste varies widely. Moreover, persistent organic pollutants such as polychlorinated dioxins and furans cannot be predicted reliably from basic elemental compositions. These dioxins and furans are toxic at extremely low concentrations. However, decreasing the percentage of halogenated plastics (such as polyvinyl chloride) reduces the amounts of hydrogen chloride and other halogenated pollutants. As much as 40% of plastic waste in modern hospitals is chlorinated plastics. To facilitate recycling, common plastics are now frequently labelled with internationally recognized symbols and numbers: 1 – polyethylene terephthalate, 2 – high-density polyethylene, 3 – polyvinyl chloride, 4 – low-density polyethylene, 5 – polypropylene, 6 – polystyrene and 7 – other. Unfortunately, many polyvinyl chloride products in health care, such as blood bags, gloves, enteral feeding sets and film wraps, are not labelled.

2.10 Minimum approach to overall management of health-care waste

All personnel dealing with health-care waste should be familiar with the main categories of health-care waste as set out in either national or local regulations on waste classification. As a minimum, managers responsible for health-care waste should conduct a walk-through of the facility to identify the medical areas that produce waste, to obtain an initial estimate of the types and quantities of waste generated, and to understand how the waste is handled and disposed of. A rapid assessment, combining observations with interviews and survey questionnaires, should provide sufficient data to identify problems and begin the process of addressing them.

2.11 Desirable improvements to the minimum approach

Beyond the minimal requirements, health-care facilities should adopt an organized approach to waste characterization to obtain accurate data. This approach is necessary to develop or improve the waste management system in use. Undertaking a formal waste assessment entails planning and preparation. From a systematic assessment, one could:

- identify locations in the health-care facility where good waste segregation is undertaken and where segregation practices need to be improved
- determine the potential for recycling and other waste-minimization measures
- estimate the quantities of hazardous health-care waste that require special handling
- obtain data to specify and size waste collection and transport equipment, storage areas, treatment technology and disposal arrangements to be used.

Key points to remember

Between 75% and 90% of the waste produced by health-care facilities is non-hazardous or general health-care waste, and only 10% to 25% of health-care waste has a hazard that requires careful management.

The distinct categories of health-care waste are sharps, infectious waste, pathological waste, pharmaceutical (including cytotoxic) waste, hazardous chemical waste, radioactive waste and non-hazardous general waste. Infectious waste can be further classified as wastes contaminated with blood or other body fluids, cultures and stocks, and waste from isolation wards. Hazardous chemical waste includes halogenated and non-halogenated solvents, disinfectants, toxic metals such as mercury, and other organic and inorganic chemicals.

Health-care waste comes from many sources, including major sources such as hospitals, clinics and laboratories, as well as minor sources such as doctors' offices, dental clinics and convalescent homes.

A significant portion of non-hazardous, general waste is recyclable or compostable.

Waste generation rates vary widely and are best estimated by local measurements.

Physicochemical characteristics of wastes vary widely and influence the suitability of individual recycling, collection, storage, transport, treatment and disposal systems.

2.12 References and further reading

References

Altin S et al. (2003). Determination of hospital waste composition and disposal methods: a case study. *Polish Journal of Environmental Studies*, 12(2):251–255.

Awad AR, Obeidat M, Al-Shareef M (2005). Mathematical-statistical models of generated hazardous hospital solid waste. *Journal of Environmental Science and Health, Part A*, 39(2):313–327.

Chih-Shan L, Fu-Tien J (1993). Physical and chemical composition of hospital waste. *Infection Control and Hospital Epidemiology*, 14(3):145–150.

Christen J (1996). *Dar es Salaam Urban Health Project. Health care waste management in district health facilities: situational analysis and system development*. St Gallen, Switzerland, Swiss Centre for Development Cooperation in Technology and Management.

DEAT (Department of Environmental Affairs and Tourism) (2006). *National Waste Management Strategy implementation South Africa: projections for health care risk waste generation*. DEAT Report Number 12/9/6. Republic of South Africa, Department of Environmental Affairs and Tourism.

- Diaz LF et al. (2008). Characteristics of health care waste. *Waste Management*, 28(7):1219–1226.
- Emmanuel J (2007). *Survey of health care waste characteristics and generation data from different countries*. New York, United Nations Development Programme Global Environment Facility Global Demonstration Project on Health Care Waste.
- Hamoda HM, El-Tomi HN, Bahman QY (2005). Variations in hospital waste quantities and generation rates. *Journal of Environmental Science and Health*, A40:467–476.
- Liberti L et al. (1994). Optimization of infectious hospital waste management in Italy. Part I: Waste production and characterization study. *Waste Management and Research*, 12(5):373–385.
- Mato RAM, Kaseva ME (1999). A critical review of industrial and medical waste practices in Dar es Salaam City. *Resources, Conservation and Recycling*, 25:271–287.
- Milburn T (1990). Biomedical Waste Incineration BACT Application Considerations. In: *Proceedings of the Third National Symposium on Infectious Waste Management*. Cited in Barton R et al. (1989). *State of the art assessment of medical waste thermal treatment*. Irvine, California, Energy & Environmental Research Corporation.
- Ministerio de Salud, Direccion General de Salud Ambiental [Ministry of Health, General Direction Environmental Health] (1995). *Diagnostico situacional del manejo de los residuos solidos de hospitales administrados per el Ministerio de Salud [Situational analysis of hospital solid waste in hospitals administered by the Ministry of Health]*. Lima, Peru, Ministerio de Salud, Direccion General de Salud Ambiental.
- Ontario Ministry of the Environment (1986). *Incinerator design and operating criteria – Volume II, Biomedical waste incineration*. Ontario, Ontario Ministry of the Environment.
- Pescod MB, Saw CB (1998). *Hospital waste management in four cities: A synthesis report*. Nieuwehaven, Netherlands, Urban Waste Expertise Programme, WASTE (UWEP Working Document 8).
- Sengupta S (1990). *Medical waste generation, treatment and disposal practices in the state of Florida*. Gainesville, State University System of Florida, Florida Center for Solid and Hazardous Waste Management (Report 90-3).
- Tudor TL (2007). Towards the development of a standardized measurement unit for health care waste generation. *Resources, Conservation and Recycling* 50:319–333.
- WHO (World Health Organization) (2004). *Laboratory biosafety manual*, 3rd ed. Geneva, World Health Organization.

Further reading

- Economopoulos AP (1993). *Environmental technology series: assessment of sources of air, water and land pollution. A guide to rapid source inventory techniques and their use in formulating environmental control strategies. Part 1: Rapid inventory techniques in environmental pollution*. Geneva, World Health Organization.
- Halbwachs H (1994). Solid waste disposal in district health facilities. *World Health Forum*, 15:363–367.
- Johannessen LM (1997). Management of health care waste. In: *Proceedings of the Environment '97 Conference*, 16–18 February 1997, Cairo. Dokki-Giza, Egyptian Environmental Affairs Agency.
- NCSA (National Conservation Strategy [Coordinating] Agency) (1996). *Study on the management of medical wastes*. Gaborone, Botswana, National Conservation Strategy (Co-ordinating) Agency (Report No. NCS/GTZ 7/96, in cooperation with the German Agency for Technical Cooperation, coordinated by Integrated Skills Ltd).

PAHO (Pan American Health Organization) (1994). *Hazardous waste and health in Latin America and the Caribbean*. Washington, DC, Pan American Health Organization.

Secretariat of the Basel Convention (2003). *Technical guidelines on the environmentally sound management of biomedical and health care wastes (Y1; Y3)*. Basel Convention series/SBC No. 2003/3. Châtelaine, Secretariat of the Basel Convention/United Nations Environment Programme.

WHO (World Health Organization) (1985). *Management of waste from hospitals and other health care establishments*. Report on a WHO meeting, Bergen, 28 June – 1 July 1983. EURO Reports and Studies, No. 97. Copenhagen, World Health Organization.

WHO CEPIS (Council of European Professional Informatics Societies) (1994). *Guia para el manejo interno de residuos solidos hospitalarios* [Guide to the internal management of solid hospital waste]. Lima, World Health Organization/Pan American Sanitary Engineering and Environmental Sciences Center.

3

Risks associated with health-care waste

Key questions to answer

What are the main types of hazards associated with health-care waste?

What are the benefits from good health-care waste management?

Who is at risk from health-care waste?

What are the public health risks of health-care waste?

What are the environmental risks of health-care waste?

3.1 Overview of hazards

This chapter is concerned with identifying the types of hazards associated with health-care waste and who may be at risk from them by describing the public and environmental health impacts that need to be controlled. The large component of non-hazardous health-care waste is similar to municipal waste and should not pose any higher risk than waste produced in households. It is the smaller hazardous health-care waste component that needs to be properly managed so that the health risks from exposure to known hazards can be minimized. Protection of the health of staff, patients and the general public is the fundamental reason for implementing a system of health-care waste management.

3.1.1 Types of hazards

The hazardous nature of health-care waste is due to one or more of the following characteristics:

- presence of infectious agents
- a genotoxic or cytotoxic chemical composition
- presence of toxic or hazardous chemicals or biologically aggressive pharmaceuticals
- presence of radioactivity
- presence of used sharps.

3.1.2 Persons at risk

All individuals coming into close proximity with hazardous health-care waste are potentially at risk from exposure to a hazard, including those working within health-care facilities who generate hazardous waste, and those who either handle such waste or are exposed to it as a consequence of careless actions.

The main groups of people at risk are:

- medical doctors, nurses, health-care auxiliaries and hospital maintenance personnel
- patients in health-care facilities or receiving home care
- visitors to health-care facilities
- workers in support services, such as cleaners, people who work in laundries, porters

- workers transporting waste to a treatment or disposal facility
- workers in waste-management facilities (such as landfills or treatment plants), as well as informal recyclers (scavengers).

The general public could also be at risk whenever hazardous health-care waste is abandoned or disposed of improperly. The hazards associated with scattered, small sources of health-care waste should not be overlooked. These sources include pharmaceutical and infectious waste generated by home-based health care, and contaminated disposable materials such as from home dialysis and used needles from insulin injection, or even illicit intravenous drug use.

3.1.3 Hazards from infectious waste and sharps

Infectious waste should always be assumed to potentially contain a variety of pathogenic microorganisms. This is because the presence or absence of pathogens cannot be determined at the time a waste item is produced and discarded into a container. Pathogens in infectious waste that is not well managed may enter the human body through several routes:

- through a puncture, abrasion or cut in the skin
- through mucous membranes
- by inhalation
- by ingestion.

The transmission of infection and its control is illustrated by a “chain of infection” diagram (Box 3.1). Each link in the chain must be present and in the precise sequential order for an infection to occur. Health workers should understand the significance of each link and the means by which the chain of infection can be interrupted. Consequently, good health-care waste management can be viewed as an infection-control procedure. It is also important to note that breaking any link in the chain will prevent infection, although control measures for health-care waste are most often directed at the “mode of transmission” stage in the chain of infection.

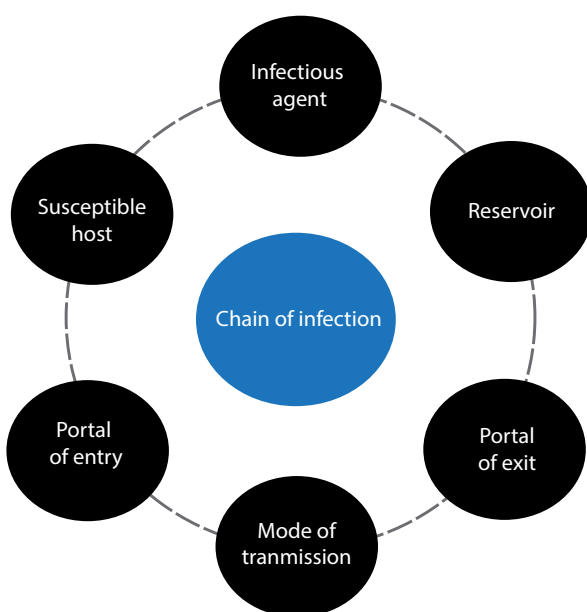

Box 3.1 Chain of infection

Infectious agent: a microorganism that can cause disease

Reservoir: a place where microorganisms can thrive and reproduce (e.g. in humans, animals, inanimate objects)

Portal of exit: a means for a microorganism to leave the reservoir (e.g. respiratory, genitourinary and gastrointestinal tracts; skin and mucous membranes; and the placenta)

Mode of transmission: how the microorganism moves from one place to another (e.g. contact, droplets, airborne)

Portal of entry: an opening allowing the microorganism to invade a new host

Susceptible host: a person susceptible to the disease, lacking immunity or physical resistance to prevent infection

Source: Adapted from Korn & Lux (2001)

Examples of infections that might be caused by exposure to health-care waste are listed in Table 3.1, together with the body fluids that are the usual vehicles of transmission and that contaminate waste items. Concentrated cultures of pathogens and contaminated sharps (particularly hypodermic needles) are the waste items that pose the most acute potential hazards to health.

Table 3.1 Potential infections caused by exposure to health-care wastes, causative organisms and transmission vehicles

Type of infection	Examples of causative organisms	Transmission vehicles
Gastroenteric infections	Enterobacteria, e.g. <i>Salmonella</i> , <i>Shigella</i> spp., <i>Vibrio cholerae</i> , <i>Clostridium difficile</i> , helminths	Faeces and/or vomit
Respiratory infections	<i>Mycobacterium tuberculosis</i> , measles virus, <i>Streptococcus pneumoniae</i> , severe acute respiratory syndrome (SARS)	Inhaled secretions, saliva
Ocular infection	Herpesvirus	Eye secretions
Genital infections	<i>Neisseria gonorrhoeae</i> , herpesvirus	Genital secretions
Skin infections	<i>Streptococcus</i> spp.	Pus
Anthrax	<i>Bacillus anthracis</i>	Skin secretions
Meningitis	<i>Neisseria meningitidis</i>	Cerebrospinal fluid
Acquired immunodeficiency syndrome (AIDS)	Human immunodeficiency virus (HIV)	Blood, sexual secretions, body fluids
Haemorrhagic fevers	Junin, Lassa, Ebola and Marburg viruses	All bloody products and secretions
Septicaemia	<i>Staphylococcus</i> spp.	Blood
Bacteraemia	Coagulase-negative <i>Staphylococcus</i> spp. (including methicillin-resistant <i>S. aureus</i>), <i>Enterobacter</i> , <i>Enterococcus</i> , <i>Klebsiella</i> and <i>Streptococcus</i> spp.	Nasal secretion, skin contact
Candidaemia	<i>Candida albicans</i>	Blood
Viral hepatitis A	Hepatitis A virus	Faeces
Viral hepatitis B and C	Hepatitis B and C viruses	Blood and body fluids
Avian influenza	H5N1 virus	Blood, faeces

There is particular concern about infection with human immunodeficiency virus (HIV) and hepatitis viruses B and C, for which there is strong evidence of transmission from injury by syringe needles contaminated by human blood, which can occur when sharps waste is poorly managed. Although theoretically any needle-stick injury can lead to the transmission of bloodborne infections, there is some evidence that hollow needles are associated with a higher risk of transmission than solid needles, such as suture needles (Puro, Petrosillo & Ippolito, 1995; Trim & Elliott, 2003; Ganczak, Milona & Szych, 2006). Sharps represent a double risk. They may not only cause physical injury but also infect these wounds if they are contaminated with pathogens. The principal concern is that infection may be transmitted by subcutaneous introduction of the causative agent (e.g. viral blood infections).

The existence in health-care facilities of bacteria resistant to antibiotics and chemical disinfectants may also contribute to the hazards created by poorly managed health-care waste. It has been demonstrated that plasmids from laboratory strains contained in health-care waste were transferred to indigenous bacteria via the waste disposal system (Novais et al., 2005). Moreover, antibiotic-resistant *Escherichia coli* have been shown to survive in an activated sludge plant, although there does not seem to be significant transfer of this organism under normal conditions of wastewater disposal and treatment.

3.1.4 Hazards from chemical and pharmaceutical waste

Many of the chemicals and pharmaceuticals used in health care are hazardous. They are commonly present in small quantities in health-care waste, whereas larger quantities may be found when unwanted or outdated chemicals and pharmaceuticals are sent for disposal. Chemical wastes may cause intoxication, either by acute or chronic exposure, or physical injuries – the most common being chemical burns. Intoxication can result from absorption of a chemical or pharmaceutical through the skin or the mucous membranes, or from inhalation or ingestion. Injuries to the skin, the eyes or the mucous membranes of the airways can occur by contact with flammable, corrosive or reactive chemicals (e.g. formaldehyde and other volatile substances).

Laboratory staff are regularly exposed to dozens of chemicals during the course of their work, especially in specialist and research hospitals.

The hazardous properties most relevant to wastes from health care are as follows:

- **Toxic.** Most chemicals are toxic at some level of exposure. Fumes, dusts and vapours from toxic materials can be especially harmful because they can be inhaled and pass quickly from the lungs into the blood, permitting rapid circulation throughout the body.
- **Corrosive.** Strong acids and alkali bases can corrode completely through other substances, including clothing. If splashed on the skin or eyes, they can cause serious chemical burns and permanent injury. Some of these also break down into poisonous gases, which further increase their hazardousness.
- **Explosive.** Some materials can explode when exposed to heat or flame, notably flammable liquids when ignited in confined spaces, and the uncontrolled release of compressed gases.
- **Flammable.** Compounds with this property catch fire easily, burn rapidly, spread quickly and give off intense heat. Many materials used and stored in medical areas, laboratories and maintenance workshops are flammable, including solvents, fuels and lubricants.
- **Chemically reactive.** These materials should be used with extreme caution and stored in special containers. Some can burn when exposed to air or water, some when mixed with other substances. It is important to note that reactive materials do not have to be near heat or flames to burn. They may burn spontaneously in the presence of air and also give off vapours that may be harmful if inhaled.

Common chemical waste types

Mercury

Mercury is a naturally occurring heavy metal. At ambient temperature and pressure, mercury is a silvery-white liquid that readily vaporizes and may stay in the atmosphere for up to a year. When released to the air, mercury is transported by air currents, ultimately accumulating in marine and lake bottom sediments. In these environments, bacteria can transform inorganic mercury compounds into an organic form – methyl mercury – which is known to accumulate in fish tissue and subsequently affect humans through the food chain (Box 3.2).

Mercury is highly toxic, especially in elemental form or as methyl mercury. It may be fatal if inhaled and harmful if absorbed through the skin. Around 80% of the inhaled mercury vapour is absorbed into the blood through the lungs. The nervous, digestive, respiratory and immune systems and kidneys can be harmed, as well as the lungs. Adverse health effects from mercury exposure can be tremors, impaired vision and hearing, paralysis, insomnia, emotional instability, developmental deficits during fetal development, and attention deficit and developmental delays during childhood. Recent studies suggest that mercury may have no threshold below which some adverse effects do not occur (WHO, 2005).

Box 3.2 Health sector contribution of mercury in the environment

Mercury is used in several medical devices, especially fever thermometers and blood-pressure monitoring equipment. These represent a hazard in terms of both breakage and long-term disposal. A less well-known source of mercury in medical waste is batteries, particularly the small button batteries. American and European manufacturers are removing mercury from their products, but it may still be present in those produced elsewhere (EC, 2006; Department of Environmental Protection, 2009). Many health-care facilities have adopted a policy of gradual replacement with mercury-free alternatives.

Health-care facilities also contribute up to 5% of the release of mercury to water bodies through untreated wastewater. Environment Canada estimates that one third of mercury load in sewerage systems comes from dental practices.

Health-care waste incineration is one of the main sources of mercury release into the atmosphere from health-care facilities. The United States Environmental Protection Agency estimates that medical incinerators may have historically contributed up to 10% of mercury air releases.

In the United Kingdom, more than 50% of total mercury emissions come from mercury contained in dental amalgam, and laboratory and medical devices.

Sources: Risher (2003); WHO (2005)

Silver

The use of mercury in health care is decreasing. Conversely, silver, another toxic heavy metal, is being used in ever more applications, including as a bactericide and in nanotechnology. In large doses, it can turn a person's skin permanently grey. There is increasing concern with both regulators and others about the potential effects of silver, including the possibility that bacteria develop resistance to the metal and subsequently also develop a resistance to antibiotics (Chopra, 2007; Senjen & Illuminato, 2009).

Disinfectants

Disinfectants, such as chlorine and quaternary ammonium, are used in large quantities in health-care facilities, and are corrosive. It should also be noted that reactive chemicals such as these may form highly toxic secondary compounds. Where chlorine is used in an unventilated place, chlorine gas is generated as a by-product of its reaction with organic compounds. Consequently, good working practices should be used to avoid creating situations where the concentration in air may exceed safety limits.

Pesticides

Obsolete pesticides, stored in leaking drums or torn bags, can directly or indirectly affect the health of anyone who comes into contact with them. During heavy rains, leaking pesticides can seep into the ground and contaminate groundwaters. Poisoning can occur through direct contact with a pesticide formulation, inhalation of vapours, drinking contaminated water or eating contaminated food. Other hazards may include the possibility of spontaneous combustion if improperly stored, and contamination as a result of inadequate disposal, such as open burning or indiscriminate burying.

3.1.5 Hazards from genotoxic waste

Special care in handling genotoxic waste is essential. The severity of the hazards for health-care workers responsible for the handling or disposal of genotoxic waste is governed by a combination of the substance toxicity itself and the extent and duration of exposure. Exposure to genotoxic substances in health care may also occur during the preparation of, or treatment with, particular drugs or chemicals. The main pathways of exposure are inhalation of dust or aerosols, absorption through the skin, ingestion of food accidentally contaminated with cytotoxic drugs, ingestion as a result of bad practice, such as mouth pipetting, or from waste items. Exposure may also occur through contact with body fluids and secretions of patients undergoing chemotherapy.

The cytotoxicity of many antineoplastic drugs is cell-cycle specific, targeted on specific intracellular processes such as DNA synthesis and mitosis. Other antineoplastics, such as alkylating agents, are not phase specific but are cytotoxic at any point in the cell cycle. Experimental studies have shown that many antineoplastic drugs are

carcinogenic and mutagenic; secondary neoplasia (occurring after the original cancer has been eradicated) is known to be associated with some forms of chemotherapy.

Many cytotoxic drugs are extreme irritants and have harmful local effects after direct contact with skin or eyes (Box 3.3). Cytotoxic drugs may also cause dizziness, nausea, headache or dermatitis. Additional information on health hazards from cytotoxic drugs may be obtained on request from the International Agency for Research on Cancer (IARC).¹

Any discharge of genotoxic waste into the environment could have disastrous ecological consequences.

Box 3.3 Cytotoxic drugs hazardous to eyes and skin

Alkylating agents

Vesicant (blistering) drugs: aclarubicin, chlormethine, cisplatin, mitomycin

Irritant drugs: carmustine, cyclophosphamide, dacarbazine, ifosfamide, melphalan, streptozocin, thiotepa

Intercalating agents

Vesicant drugs: amsacrine, dactinomycin, daunorubicin, doxorubicin, epirubicin, pirarubicin, zorubicin

Irritant drugs: mitoxantrone

Vinca alkaloids and derivatives

Vesicant drugs: vinblastine, vincristine, vindesine, vinorelbine

Epipodophyllotoxins

Irritant drugs: teniposide

3.1.6 Hazards from radioactive waste

The nature of illness caused by radioactive waste is determined by the type and extent of exposure. It can range from headache, dizziness and vomiting to much more serious problems. Radioactive waste is genotoxic, and a sufficiently high radiation dose may also affect genetic material. Handling highly active sources, such as those used in diagnostic instruments (e.g. gallium sealed sources) may cause much more severe injuries, including tissue destruction, necessitating the amputation of body parts. Extreme cases can be fatal.

The hazards of low-activity radioactive waste may arise from contamination of external surfaces of containers or improper mode or duration of waste storage. Health-care workers, and waste-handling and cleaning personnel exposed to radioactivity are most at risk.

3.1.7 Hazards from health-care waste-treatment methods

In addition to the specific hazards posed by different types of health-care waste, there are occupational hazards associated with waste-treatment processes. Some are similar to those common in industries using machinery:

- Flue gases from waste incinerators may have an impact on people living and working close to a treatment site. The health risk is most serious where an incinerator is improperly operated or poorly maintained. If poorly controlled, emissions from waste incinerators may cause health concern from particulates (associated with increased cardiovascular and respiratory mortality and morbidity); volatile metals, such as mercury and cadmium (associated with damage to the immune system, neurological system, lungs and kidneys); and dioxins, furans and polycyclic aromatic hydrocarbons (which are known carcinogens but may also cause other serious health effects) (Fritsky, Kumm & Wilken, 2001; Levendis et al., 2001; Matsui, Kashima & Kawano, 2001; Brent & Rogers, 2002; Lee et al., 2002; Rushton, 2003; Lee, Ellenbecker & Moure-Eraso, 2004; Segura-Muñoz et al., 2004).

¹ See <http://www.iarc.fr>

- Ash from the incineration of hazardous health-care waste may continue to pose a risk. Burnt-out needles and glass may have been disinfected but can still cause physical injury. Furthermore, incinerator ash may contain elevated concentrations of heavy metals and other toxic items, and the ash provides ideal conditions for the synthesis of dioxins and furans, because it is often exposed for a long time to a temperature range of 200–450 °C.
- Autoclave and steam disinfection treatment methods can also pose potential hazards that need to be managed. In particular, good maintenance and operation should be undertaken to avoid physical injuries from high operating temperatures and steam generation. Post-waste treatment water contains organic and inorganic contaminants. The concentrations should be monitored to ensure that discharges to sewerage systems are within regulated limits.
- Health-care waste treatment mechanical equipment, such as shredding devices and waste compactors, can cause physical injury when improperly operated or inadequately maintained.
- Burial of health-care waste in landfill sites may pose hazards to workers and public. The risks are often difficult to quantify, and the most likely injury comes from direct physical contact with waste items. Chemical contaminants or pathogens in landfill leachate may be released into surface streams or groundwater. On poorly controlled land-disposal sites, the presence of fires and subsurface burning waste poses the further hazard of airborne smoke. The smoke may contain heavy metals and other chemical contaminants that over time may affect the health of site workers and the general public.

3.2 Public sensitivity

Quite apart from fear of health hazards, the general public is sensitive about the visual impact of anatomical waste, particularly recognisable human body parts, including fetuses. There are no normal circumstances where it is acceptable to dispose of anatomical waste inappropriately, such as dumping in a landfill.

In Muslim and some other cultures, especially in Asia, religious beliefs require human body parts to be returned to a patient's family and buried in cemeteries.

3.3 Public health impact

3.3.1 Impacts of infectious waste and sharps

In the year 2000, sharps injuries to health-care workers were estimated to have caused about 66 000 hepatitis B (HBV), 16 000 hepatitis C (HCV) and 200–5000 HIV infections among health-care workers (Prüss-Ustun et al., 2005). For health-care workers, the fractions of these infections that are due to percutaneous occupational exposure to HBV, HCV and HIV are 37%, 39% and 4%, respectively. It is estimated that more than two million health-care workers are exposed to percutaneous injuries with infected sharps every year (Prüss-Üstün et al., 2005). In certain facilities and countries, health-care workers may have several percutaneous sharps injuries per year, although this could be avoided by training on the safe management of sharps. Table 3.2 lists the common medical and waste-management procedures that led to a sharps injury, in selected countries. Scavengers on waste disposal sites are also at significant risk from used sharps (although these risks are not well documented). The risk of a sharps injury among patients and the public is much lower.

Table 3.2 Frequency of procedure that health-care workers were using at the moment of percutaneous injury, selected countries

Country (reference)	Procedure involved in the accident (%) ^a					
	Recapping	Stuck by colleague	Disassembling device	During disposal	Unattended needle	Movement of patient
New Zealand (Lum et al., 1997)	15.0	NR	NR	21.0	NR	NR
Nigeria (Adegboye et al., 1994)	18.0	18.0	10.0	NR	NR	29.0
South Africa (Karstaedt & Pantanowitz, 2001)	17.4	7.2	3.0	9.6	4.8	23.4
Taiwan (Guo et al., 1999)	32.1	3.1	2.6	6.1	NR	NR
USA (Mangione et al., 1991)	12.0	NR	NR	13.0	8.0	NR

NR, not reported; USA, United States of America

^a The percentages do not sum to 100% because individual studies reported different categories of procedures from those in this table.

Source: Rapiti, Prüss-Üstün & Hutin (2005)

The annual rates of injuries from sharps in medical waste for health-care and sanitary service personnel, within and outside hospitals, were estimated by the United States Agency for Toxic Substances and Diseases Registry (ATSDR) in its report to Congress on medical waste (ATSDR, 1990). Many injuries are caused by recapping of hypodermic needles before disposal into sharps containers, by unnecessary opening of these containers, and by using materials that are not puncture-proof to construct these containers.

Box 3.4 summarizes data on occupational transmission of HIV. As of 30 June 1999, 191 American workers had been reported to the Centers for Disease Control and Prevention's (CDC's) national surveillance system for occupationally acquired HIV infection. Of this number, 136 workers reported occupational exposures to blood, body fluids, or laboratory specimens containing HIV, and were considered possible cases of occupationally acquired HIV infection (Beltrami et al., 2000). The risk of viral hepatitis B and C infection from contact with health-care waste may be more significant, because these viruses are viable outside a host for longer than HIV.

The ATSDR report estimated the annual numbers of HBV infections resulting from injuries from sharps among medical personnel and waste-management workers (Table 3.3). The annual number of HBV infections in the United States of America resulting from exposure to health-care waste was between 162 and 321, out of an overall yearly total of 300 000 cases from all causes.

There were insufficient data on other infections linked to health-care waste to allow any conclusions to be reached. However, on the basis of the figures for HBV, all personnel handling health-care waste should be immunized against the disease. A similar approach is not possible for HBC, because no vaccine is available.

Box 3.4 Occupational transmission of HIV in France and the United States of America

France

In 1992, eight cases of human immunodeficiency virus (HIV) infection were recognized as occupational infections. Two of these cases, involving transmission through wounds, occurred in waste handlers.

USA

In 1997, the Centers for Disease Control and Prevention (CDC) recognized 52 HIV infections as occupational infections, 45 of which were caused by percutaneous exposure, and 5 of which were caused by mucocutaneous exposure.

The infections caused by percutaneous exposure occurred through the following pathways:

- 41 hollow-bore needles
- 2 broken glass vials
- 1 scalpel
- 1 unknown sharp object.

Source: Bouvet & Groupe d'Etude sur le Risque d'Exposition au Sang, 1993; CDC, 1998

Table 3.3 Viral hepatitis B infections caused by occupational injuries from sharps (USA)

Professional category	Annual number of people injured by sharps	Annual number of HBV infections caused by injury
Nurses:		
in hospital	12 600–22 200	56–96
outside hospital	28 000–48 000	26–45
Hospital laboratory workers	800–7500	2–15
Hospital housekeepers	11 700–45 300	23–91
Hospital technicians	12 200	24
Physicians and dentists in hospital	100–400	<1
Physicians outside hospital	500–1700	1–3
Dentists outside hospital	100–300	<1
Dental assistants outside hospital	2600–3900	5–8
Emergency medical personnel (outside hospital)	12 000	24
Waste workers (outside hospital)	500–7300	1–15

HBV, hepatitis B virus; USA, United States of America
Source: ATSDR (1990)

An outbreak of hepatitis B in Gujarat, India, in 2009 is thought to have claimed the lives of 60 people and was blamed on the reuse of injection equipment. It led to the discovery of a black market where used needles and syringes were repackaged and resold (Harhay et al., 2009; Solberg, 2009).

In any health-care facility, nurses and housekeeping personnel are the main groups at risk of injury, with annual injury rates in the USA at 10–20 per 1000 workers. The highest rates of occupational injury among all workers exposed to health-care waste are reported by cleaning personnel and waste handlers. In the USA, the annual rate is 180 per 1000 workers. The most numerous work-related injuries among health-care workers and waste collectors are sprains and strains caused by lifting and overexertion, and not from the hazardous components of health-care waste.

3.3.2 Impacts of chemical and pharmaceutical waste

There is no scientifically documented evidence of widespread illnesses among the general public due to chemical or pharmaceutical waste from hospitals. Excreted pharmaceuticals from patients do find their way into waterways, which can contribute to potentially serious environmental effects, including toxicity to wildlife and the generation of antibiotic resistance in bacteria (e.g. Guardabassi et al., 1998).

Pharmacists, anaesthetists, and nursing, auxiliary and maintenance personnel may be at risk of respiratory or dermal diseases caused by exposure to chemicals and pharmaceuticals. To minimize this type of occupational risk, less hazardous chemicals should be substituted whenever possible and protective equipment provided to all personnel likely to be exposed. Buildings in which hazardous chemicals are used should be properly ventilated, and personnel handling hazardous materials should be trained in preventive measures and emergency care in case of accident.

3.3.3 Impacts of genotoxic waste

There are very little data on the long-term health impacts of genotoxic health-care waste. This is partly because of the difficulty of assessing human exposure to this type of compound. A study undertaken in Finland found an excess of spontaneous abortions during pregnancy and malformations in children of females with a history of working with anticancer agents (Sorsa et al., 1985). Studies in Canada and the United States of America have shown similar results (Valanis, Vollmer & Steele, 1999; Dranitsaris et al., 2005). A meta-analysis of 14 studies between 1966 and 2004 found no significant association between exposure to cytotoxic drugs and congenital malformations, but identified an association with spontaneous abortion (Dranitsaris et al., 2005)

Numerous published studies have investigated the potential health hazard associated with the handling of antineoplastic drugs, manifested by increased urinary levels of mutagenic compounds in exposed workers and an increased risk of abortion. A study by Sessink et al. (1992) demonstrated that exposure of personnel cleaning hospital urinals exceeded that of nurses and pharmacists. These individuals were less aware of the potential danger and took fewer precautions. The concentration of cytotoxic drugs in the air inside hospitals has been examined in a number of studies designed to evaluate health risks linked to such exposure.

3.3.4 Impacts of radioactive waste

Several accidents resulting from improper disposal of radioactive health-care waste have been reported.

One extreme case from Brazil demonstrated a carcinogenic impact on the general population from an unintended exposure to radioactive waste from a health-care facility. While moving to a new site, a radiotherapy institute left a sealed radioactive source in equipment at its old premises. An individual who gained access to these premises removed the sealed source, took it home and broke open the casing to reveal the radioactive material. As a consequence, 249 people were exposed, of whom several died or suffered severe health problems (IAEA, 1988).

With the exception of the Brazil incident, no reliable scientific data are available on the impact from the routine generation and handling of radioactive health-care waste. The only recorded accidents involve exposure to ionizing radiations in health-care facilities as a result of unsafe operation of X-ray apparatuses, improper handling of radiotherapy solutions or inadequate control of doses of radiation during radiotherapy.

3.4 Survival of pathogenic microorganisms in the environment

Pathogenic microorganisms have limited ability to survive in the environment. This ability is specific to each microorganism and is a function of its resistance to environmental conditions, such as temperature, humidity, ultraviolet irradiation, availability of organic substrate material and presence of predators.

The hepatitis B virus is very persistent in dry air and can survive for up to one week under optimal conditions, and has been detected in discarded needles (Cocchi et al., 1984; Painsil et al., 2010; Walsh Pierce & Hart, 1987). It is also resistant to brief exposure to boiling water and remains viable for up to 10 hours at a temperature of 60 °C. It can survive exposure to some antiseptics and to 70% ethanol.

By contrast, HIV is much less resistant. It survives for no more than 15 minutes when exposed to 70% ethanol and only three to seven days at ambient temperature. It is inactivated at 56 °C.

Bacteria are less resistant than viruses. Prions – agents of degenerative neurological diseases such as Creutzfeldt–Jakob disease and kuru – bind strongly to soil and are very resistant (Johnson et al., 2006; Saunders, Bartelt-Hunt & Bartz, 2008).

With the exception of waste containing pathogenic cultures or excreta from infected patients, the microbial load of health-care waste is generally not very high. Furthermore, health-care wastes do not seem to provide favourable media for the survival of pathogens, perhaps because they frequently contain antiseptics. Results from several studies have shown that the concentration of indicator microorganisms in health-care waste is generally no higher than in domestic waste and that survival rates are low.

In evaluating the survival or spread of pathogenic microorganisms in the environment, the role of vectors such as rodents and insects should be considered. This applies to management of health-care waste both within and outside health-care facilities. Vectors such as rats, flies and cockroaches, which feed or breed on organic waste, are well-known passive carriers of microbial pathogens; their populations may increase dramatically where there is mismanagement of waste.

3.5 The need for further research and epidemiological surveys

Very few data are available on the health impacts of exposure to health-care waste, particularly in the case of developing countries. However, because the amount of waste produced globally is growing faster than the infrastructure to deal with it, it is thought that at least half the world's population is at risk from environmental, occupational or public-health exposure to poor health-care waste management (Harhay et al., 2009).

Better assessment of both risks and effects of exposure would permit improvements in health-care waste management and in the planning of adequate protective measures. Unfortunately, the classical application of epidemiology to the problem is difficult because of methodological complications and uncertainties regarding evaluation of both exposure and health outcome. The great diversity of hazardous wastes that can be involved and of circumstances of exposures is a particularly problematic feature of all such evaluations. Nevertheless, suspected cases of adverse health effects from health-care waste should be adequately documented, with precise descriptions of exposure, identification and quantification of exposed individuals or populations, and recording of the eventual outcome.

Within health-care establishments, the surveillance of infection and record keeping are important tools to identify indications of inadequate waste-management practices or contamination of the immediate environment. Surveillance allows an outbreak of infection or other hazard to be recognized and investigated. It also provides a basis for introducing control measures, assessing their efficacy, reinforcing routine preventive measures and determining the level of avoidable infection.

Key points to remember

Individuals, public health and the environment are exposed to potential risks inherent in health-care waste.

Elevated risk is most likely to occur from poorly managed sharps waste and to a lesser extent from infectious waste, chemical and pharmaceutical waste, and radioactive waste.

Concentrated cultures of pathogens and contaminated sharps (particularly hypodermic needles) are probably the waste items that represent the most acute potential hazards to health.

Whenever possible, minimizing the generation of hazardous health waste is the best practice to prevent the occurrence of risks from the waste.

Very few data are available on the impact on medical and support workers from most components in health-care waste, but this should not prevent the use of sensible measures for safe waste handling and treatment at every health-care facility.

3.6 References and further reading

References

Adegboye AA et al. (1994). The epidemiology of needlestick and sharp instrument accidents in a Nigerian hospital. *Infection Control and Hospital Epidemiology*, 15(1):27–31.

ATSDR (Agency for Toxic Substances and Disease Registry) (1990). *The public health implications of medical waste: a report to congress*. Atlanta, Georgia, US Department of Health and Human Services, Agency for Toxic Substances and Disease Registry.

Beltrami EM et al. (2000). Risk and management of blood-borne infections in health care workers. *Clinical Microbiology Reviews*, 13(3):385–407.

Bouvet E, Groupe d'Etude sur le Risque d'Exposition au Sang (GERES) (1993). Risque professionnel d'infection par le virus de l'immunodéficience humaine. Synthèse des connaissances actuelles et évolution de la prévention [Risk for health professionals of infection with human immunodeficiency virus. Current knowledge and developments in preventive measures]. *Médecine et Maladies Infectieuses*, 23:28–33.

Brent A, Rogers D (2002). Establishing the propensity for dioxin formation using a plume temperature model for medical waste incinerator emissions in developing countries. *Journal of the Air & Waste Management Association*, 52:811–821.

CDC (Centers for Disease Control and Prevention) (1998). Public health service guidelines for the management of health-care worker exposures to HIV and recommendations for postexposure prophylaxis. *Morbidity and Mortality Weekly Reports*, 47(RR-7):1–28.

Chopra I (2007). The increasing use of silver-based products as antimicrobial agents: a useful development or a cause for concern? *Journal Antimicrobial Chemotherapy*, 59:587–590.

Cocchi P et al. (1984). Risk of contracting hepatitis B from discarded syringes. *Lancet*, 1:1356.

Department of Environmental Protection (2009). *Mercury-free button batteries: their reliability and availability*, Augusta, Maine, State of Maine Department of Environmental Protection.

Dranitsaris G et al. on behalf of the Safe Handling of Cytotoxics Working Group (2005). Are health care providers who work with cancer drugs at an increased risk for toxic events? A systematic review and meta-analysis of the literature. *Journal of Oncology Pharmacy Practice*, (2):69–78.

- EC (European Commission) (2006). Directive 2006/66/EC of the European Parliament and of the Council of 6 September 2006 on batteries and accumulators and waste batteries and accumulators and repealing Directive 91/157/EEC. *Official Journal of the European Union*, L 266:1–13.
- Fritsky K, Kumm J, Wilken M (2001). Combined PCDD/F destruction and particulate control in a baghouse: experience with a catalytic filter system at a medical waste incineration plant. *Journal of the Air and Waste Management Association*, 51:1642–1649.
- Ganczak M, Milona M, Szych Z (2006). Nurses and occupational exposures to bloodborne viruses in Poland. *Infection Control and Hospital Epidemiology*, 27(2):175–180.
- Guardabassi L et al. (1998). Antibiotic resistance in *Acinetobacter* spp. isolated from sewers receiving waste effluent from a hospital and a pharmaceutical plant. *Applied and Environmental Microbiology*, 64(9):3499–3502.
- Guo YL et al. (1999). Needlestick and sharps injuries among health-care workers in Taiwan. *Epidemiology and Infection*, 122:259–265.
- Harhay MO et al. (2009). Health care waste management: a neglected and growing public health problem worldwide. *Tropical Medicine and International Health*, 14(11):1414–1417.
- IAEA (International Atomic Energy Agency) (1988). *The radiological accident in Goiânia*. Vienna, International Atomic Energy Agency.
- Johnson CJ et al. (2006). Prions adhere to soil minerals and remain infectious. *PLoS Pathogens*, 2(4):e32.
- Karstaedt AS, Pantanowitz L (2001). Occupational exposure of interns to blood in an area of high HIV seroprevalence. *South African Medical Journal*, 91(1):57–61.
- Korn SP, Lux J (2001). *Infection control for nursing students*. Chicago, Truman College (<http://faculty.ccc.edu/tr-infectioncontrol/index.htm>).
- Lee B, Ellenbecker M, Moure-Eraso R (2004). Alternatives for treatment and disposal cost reduction of regulated medical wastes. *Waste Management*, 24:143–151.
- Lee W-J et al. (2002). Emission of polycyclic aromatic hydrocarbons from medical waste incinerators. *Atmospheric Environmental*, 36:781–790.
- Levendis YA et al. (2001). PAH and soot emissions from burning components of medical waste: examination/surgical gloves and cotton pads. *Chemosphere*, 42:775–783.
- Lum D et al. (1997). Needle stick injuries in country general practice. *New Zealand Medical Journal*, 110:122–125.
- Mangione CM, Gerberding JL, Cummings SR (1991). Occupational exposure to HIV: frequency and rate of underreporting of percutaneous and mucocutaneous exposure by medical house staff. *American Journal of Medicine*, 90(1):85–90.
- Matsui M, Kashima Y, Kawano M (2003). Dioxin-like potencies and extractable organohalogen (EOX) in medical, municipal and domestic waste incinerator ashes in Japan. *Chemosphere*, 53:971–980.
- Novais C et al. (2005). Environmental contamination with vancomycin-resistant enterococci from hospital sewage in Portugal. *Applied and Environmental Microbiology*, 71(6):3364–3368.
- Paintsil E et al. (2010). Survival of hepatitis C virus in syringes: implication for transmission among injection drug users. *Journal of Infectious Diseases*, 202(7):984–990.

- Prüss-Üstün A, Rapiti E, Hutin Y (2005). Estimating the global burden of disease attributable to contaminated sharps injuries among health care workers. *American Journal of Industrial Hygiene*, 48(6):482–490.
- Puro V, Petrosillo N, Ippolito G (1995). Risk of hepatitis C seroconversion after occupational exposures in health care workers. *American Journal of Infection Control*, 23(5):273–277.
- Rapiti E, Prüss-Üstün A, Hutin Y (2005). *Sharps injuries – assessing the burden of disease from sharps injuries to health care workers at national and local levels*. Environmental Disease Burden Series No. 11. Geneva, World Health Organization.
- Risher JF (2003). *Elemental mercury and inorganic mercury compounds: human health effects*. Geneva, World Health Organization (<http://www.who.int/ipcs/publications/cicad/en/cicad50.pdf>).
- Rushton L (2003). Health hazards and waste management. *British Medical Bulletin*, 68:183–197.
- Saunders S, Bartelt-Hunt S, Bartz J (2008). Prions in the environment: occurrence, fate and mitigation. *Prion*, 2(4):162–169.
- Segura-Muñoz SI et al. (2004). Trace metal distribution in surface soil in the area of a municipal solid waste landfill and a medical waste incinerator. *Bulletin of Environmental Contamination and Toxicology*, 72:157–164.
- Senjen R, Illuminato I (2009). *Nano and biocidal silver*. Washington DC, FoE Australia, FoE USA (http://www.foe.org/sites/default/files/Nano-silverReport_US.pdf).
- Sessink PJM et al. (1992). Occupational exposure to antineoplastic agents at several departments in a hospital. Environmental contamination and excretion of cyclophosphamide and ifosfamide in urine of exposed workers. *International Archives of Occupational and Environmental Health*, 64:105–112.
- Solberg KE (2009). Trade in medical waste causes deaths in India. *Lancet*, 373(9669):1067.
- Sorsa M, Hemminki K, Vanio H (1985). Occupational exposure to anticancer drugs: potential real hazards. *Mutation Research*, 154:135–149.
- Trim JC, Elliott TS (2003). A review of sharps injuries and preventative strategies. *Journal of Hospital Infection*, 53(4):237–242.
- Valanis B, Vollmer WM, Steele P (1999). Occupational exposure to antineoplastic agents: self-reported miscarriages and stillbirths among nurses and pharmacists. *Journal of Occupational and Environmental Medicine*, 41(8):632–638.
- Walsh SS, Pierce AM, Hart CA (1987). Drug abuse: a new problem. *British Medical Journal*, 295(6597):526–527.
- WHO (World Health Organization) (2005). *Mercury in health care policy paper*. Geneva, World Health Organization (http://www.who.int/water_sanitation_health/medicalwaste/mercurypolpap230506.pdf).

Further reading

- Allwood M, Wright P, eds (1993). *The cytotoxic handbook*. Oxford, Radcliffe Medical Press.
- ATSDR (Agency for Toxic Substances and Disease Registry) (1999). *Toxicological profile for mercury*. US Department of Health and Human Services, Agency for Toxic Substances and Disease Registry (<http://www.atsdr.cdc.gov/toxprofiles/tp.asp?id=115&tid=24>).
- Ayliffe GAJ et al., eds (1992). *Control of hospital infection: a practical handbook*, 3rd ed. London, Chapman & Hall Medical.

- Babich H (1985). Reproductive and carcinogenic health risks to hospital personnel from chemical exposure. A literature review. *Environmental Health*, 48(2):52–56.
- Benhamou S et al. (1986). Mutagenicity in urine from nurses handling cytostatic agents. *European Journal of Cancer and Clinical Oncology*, 22:1489–1493.
- Estryn-Behar M, Prugnaud JL, Sainte-Laudry J (1983). Hypersensibilité immédiate et antimitotiques. Nécessité de protection du personnel soignant [Immediate hypersensitivity and antimetabolites. The need to protect caregivers]. *Journal de Pharmacie Clinique*, 2:131–143.
- FAO (Food and Agriculture Organization of the United Nations) (1995). *Prevention of accumulation of obsolete pesticide stocks. Provisional guidelines*. Document no. GCP/INT/572/NET. Rome, Food and Agriculture Organization of the United Nations.
- Finch GR, Smith DW (1986). The survival of antibiotic-resistant *E. coli* in an activated sludge plant. *Environmental Technology Letters*, 7:487–494.
- Gealt MA et al. (1985). Transfer of plasmids pBR322 and pBR325 in wastewater from laboratory strains of *Escherichia coli* to bacteria indigenous to the waste disposal system. *Applied Environmental Microbiology*, 49(4):836–841.
- Heptonstall J, Porter K, Gill ON (1993). *Occupational transmission of HIV. Summary of published reports*. Atlanta, GA, Centers for Disease Control and Prevention.
- IARC (International Agency for Research on Cancer) (1991). *IARC monographs on the evaluation of carcinogenic risk of chemicals to humans: some antineoplastic and immunosuppressive agents*. IARC Monographs No. 26. Lyon, International Agency for Research on Cancer.
- IARC (1994). *IARC monographs on the evaluation of carcinogenic risks to humans: list of IARC evaluations*. IARC Monographs. Lyon, International Agency for Research on Cancer (<http://monographs.iarc.fr/ENG/Classification/index.php>).
- Kubitschke A et al. (2007). Injuries from needles contaminated with hepatitis C virus: how high is the risk of seroconversion for medical personnel really? *Internist (Berl.)*, 48(10):1165–1172.
- Lee MG (1988). The environmental risks associated with the use and disposal of pharmaceuticals in hospitals. In: *Proceedings of 3rd European Conference. Risk assessment of chemicals in the environment*, 491–504.
- Loft F, Abiteboul D (1994). Infections professionnelles par le VIH en France. Le point au 31 décembre 1993 [Health professionals infected with HIV in France. The situation at 31 December 1993]. *Bulletin Épidémiologique Hebdomadaire*, 5(2):111–113.
- McCay PH, Ocampo-Sosa AA, Fleming GTA (2010). Effect of subinhibitory concentrations of benzalkonium chloride on the competitiveness of *Pseudomonas aeruginosa* grown in continuous culture. *Microbiology*, 156:30–38.
- Pyy L, Sorsa M, Hakala E (1988). Ambient monitoring of cyclophosphamide in manufacture and hospitals. *American Industrial Hygiene Association Journal*, 49:314–317.
- Saurel-Cubizolles MJ, Job-Spira M, Estryn-Behar M (1983). Ectopic pregnancy and occupational exposure to antineoplastic drugs and fetal loss in nurses. *Lancet*, 341:1169–1171.
- Selevan SG et al. (1985). A study of occupational exposure to antineoplastic drugs and fetal loss in nurses. *New England Journal of Medicine*, 19:1173–1178.
- Stücker I et al. (1990). Risk of spontaneous abortion among nurses handling antineoplastic drugs. *Scandinavian Journal of Work, Environment and Health*, 16:102–107.

WHO (World Health Organization) (1992). *The hospital in rural and urban districts. Report of a WHO study group on the functions of hospitals at the first referral level.* WHO Technical Report Series No. 819. Geneva, World Health Organization.

WHO (1995). *Survey of hospital wastes management in South-East Asia Region.* New Delhi, World Health Organization.

WHO (2004). *Review of health impacts from microbiological hazards in health-care wastes.* Geneva, World Health Organization.

4

Legislative, regulatory and policy aspects of health-care waste

Key questions to answer

Is there a national policy on the management of wastes produced by health-care facilities?

Have any policies been developed at a regional or local level?

What points should be taken into consideration when producing a policy?

Has any national legislation been enacted to control the management of health-care waste?

Are there any practical guidelines for health-care managers to use locally, based on national or international standards?

Is there any system of enforcement of health-care waste laws and regulations?

4.1 Importance of a national policy

It is possible for improvements in waste management to begin in pioneering local health-care facilities. However, to have an impact more widely across a country usually requires active government intervention. The most common first step by a government ministry is to describe the changes needed in a national health-care waste-management policy. This should be seen as an important step in creating a successful and sustainable health-care waste-management system, which all health-care facilities can work towards. A policy can be viewed as a blueprint that drives decision making at a political level and should mobilize government effort and resources to create the conditions to make changes in health-care facilities.

A national policy should identify the needs and problems in the country, as well as taking into account the relevant international agreements and conventions adopted nationally that govern public health, sustainable development, the environment and safe management of hazardous waste.

Once a national policy has been prepared, typically legislation and supporting regulations governing health-care waste management, if needed, should be developed. To be most effective, regulations should describe what is expected from health-care staff and explain the methods for their enforcement. It is possible that professional organizations or influential institutions will supplement official regulations with practical guidelines and manuals, codes of good professional practice and advice shared between experienced managers. A national policy should make allowances for regional differences, and variations in local capacity and socioeconomic conditions. In addition, there are useful internationally available guidance documents produced; for example, by the World Health Organization (WHO), United Nations Environment Programme – Secretariat of the Basel Convention, and several nongovernmental organizations (NGOs) (e.g. WHO, 2005b).

4.2 Guiding principles

Five principles are widely recognised as underlying the effective and controlled management of wastes. These principles have been used by many countries when developing their policies, legislation and guidance:

- **The “polluter pays” principle** implies that all producers of waste are legally and financially responsible for the safe and environmentally sound disposal of the waste they produce. This principle also attempts to assign liability to the party that causes damage.

- The **“precautionary” principle** is a persuasive principle governing health and safety protection. It was defined and adopted under the Rio Declaration on Environment and Development (UNEP, 1972) as Principle 15: “Where there are threats of serious or irreversible damage to the environment, lack of full scientific certainty should not be used as a reason for postponing cost-effective measures to prevent environmental degradation”.
- The **“duty of care” principle** stipulates that any person handling or managing hazardous substances or wastes or related equipment is ethically responsible for using the utmost care in that task. This principle is best achieved when all parties involved in the production, storage, transport, treatment and final disposal of hazardous wastes (including health-care waste) are appropriately registered or licensed to produce, receive and handle named categories of waste.
- The **“proximity” principle** recommends that treatment and disposal of hazardous waste take place at the closest possible location to its source to minimize the risks involved in its transport. Similarly, every community should be encouraged to recycle or dispose of the waste it produces, inside its own territorial limits, unless it is unsafe to do so.
- The **“prior informed consent principle”** as embodied in various international treaties is designed to protect public health and the environment from hazardous waste. It requires that affected communities and other stakeholders be apprised of the hazards and risks, and that their consent be obtained. In the context of health-care waste, the principle could apply to the transport of waste and the siting and operation of waste-treatment and disposal facilities.

4.3 International agreements and conventions

The following international agreements and conventions are particularly relevant to the management of wastes from health-care facilities, the protection of the environment and sustainable development, and should be taken account of when preparing waste-management policy and legislation.

4.3.1 The Basel Convention

The Basel Convention on the Control of Trans-Boundary Movements of Hazardous Wastes and their Disposal (the Basel Convention) is the most comprehensive global environmental treaty on hazardous and other wastes. It has 170 member countries (parties) and aims to protect human health and the environment against the adverse effects resulting from the generation, management, transboundary movements and disposal of hazardous and other wastes.

The Basel Convention regulates the transboundary movements of hazardous and other wastes by applying the “prior informed consent” principle. Shipments without consent to and from non-parties are illegal unless there is a special agreement that contains provisions no less environmentally sound than the convention. Each party is required to introduce appropriate national or domestic legislation to prevent and punish illegal traffic in hazardous and other wastes. In addition, the convention obliges its parties to ensure that hazardous and other wastes are managed and disposed of in an environmentally sound manner. To this end, parties are expected to minimize the quantities that are moved across borders, to treat and dispose of wastes as close as possible to their place of generation, and to prevent or minimize the generation of wastes at source. Strong controls have to be applied from the moment of the generation of a hazardous waste to its storage, transport, treatment, reuse, recycling, recovery and final disposal.

The Basel Convention specifically refers to:

- Y1 – Clinical wastes from medical care in hospitals, medical centres and clinics
- Y3 – Waste pharmaceuticals, drugs and medicines.

The convention also has a category of hazardous characteristics defined as “H 6.2 – Infectious substances – substances or wastes containing viable microorganisms or their toxins which are known or suspected to cause disease in animals or humans.”

In addition, the convention secretariat has produced the comprehensive document *Technical guidelines on the environmentally sound management of biomedical and health care wastes (Y1; Y3)* (UNEP, 2003).

The Basel Convention is modified periodically through decisions made at the regular Conference of the Parties to the Basel Convention. Notably, the conference agreed (Decision III/1) to prohibit hazardous waste shipments from industrialized countries to developing countries.

4.3.2 The Bamako Convention

The Bamako Convention on the Import into Africa and the Control of Trans-Boundary Movement and Management of Hazardous Wastes within Africa (the Bamako Convention) is a treaty of African nations prohibiting the import of any hazardous (including radioactive) waste. The Bamako Convention was negotiated by 12 nations of the Organization of African Unity at Bamako, Mali, in January 1991, and came into force in 1998. Impetus for the Bamako Convention arose from criticism of the failure of the Basel Convention to prohibit trade of hazardous waste to less developed countries, and from the realization that many developed nations were exporting toxic wastes to Africa. The Bamako Convention uses a format and language similar to that of the Basel Convention, but is much stronger in prohibiting all imports of hazardous waste.

4.3.3 The Stockholm Convention

The Stockholm Convention on Persistent Organic Pollutants (POPs) (the Stockholm Convention) is a global treaty to protect human health and the environment from persistent organic pollutants (POPs). POPs are chemicals that remain intact in the environment for long periods, become widely distributed geographically, accumulate in the fatty tissue of living organisms and are toxic to humans and wildlife. POPs circulate globally and can cause damage wherever they travel.

Under Article 5 and Annex C, governments that are party to the convention are required to reduce or eliminate releases from unintentional production of POPs – in particular, polychlorinated dibenzo-p-dioxins and dibenzofurans. These chemicals are formed and released to the environment by medical waste incinerators and other combustion processes. Governments must require the use of best available techniques and promote best environmental practices for new incinerators within four years after the convention comes into force for the country.

The *Guidelines on best available techniques and provisional guidance on best environmental practices* (UNEP, 2006) were released in 2006. Section V.A.II deals specifically with health-care waste. Best environmental practices (BEP) include source reduction, segregation, resource recovery and recycling, training, and proper collection and transport. The best available techniques (BAT) guidelines for health-care waste incinerators require a combination of specified primary and secondary measures to achieve air emission levels of polychlorinated dibenzo-p-dioxins and dibenzofurans no higher than 0.1 ng I-TEQ/Nm³ (at 11% O₂), as well as dioxin and furan concentrations less than 0.1 ng I-TEQ/litre of wastewater from the flue gas treatment. The Stockholm Convention states that “priority consideration” be given to alternative processes that have similar usefulness but that avoid the formation and release of these chemicals. The BAT/BEP guidelines describe alternative technologies such as steam sterilization, advanced steam sterilization, microwave treatment, dry-heat sterilization, alkaline hydrolysis and biological treatment (UNEP, 2006).

4.3.4 The environment and sustainable development conferences

The concept of the environment and the pattern of action at national and international level to safeguard it evolved in the years leading up to the United Nations Stockholm Conference 1972. Then, in the mid-1980s, the concept of sustainable development was defined by the World Commission on Environment and Development (Brundtland Commission). In simple terms, it is defined as follows:

Sustainable development is development that meets the needs of the present without compromising the ability of future generations to meet their own needs.

For a fuller definition, see the World Commission on Environment and Development report (1987), *Our common future*.

Sustainable development was given new form and direction by the World Summit on Sustainable Development in Johannesburg in 2002. This United Nations conference led to a 300-page plan for achieving sustainable development in the 21st century, called “Agenda 21”. Ten years later in 2002, the Earth Summit was held and a Plan of Implementation was agreed. The United Nations Commission for Sustainable Development was charged with carrying out the plan, based upon a strategy of two-year implementation cycles.

4.3.5 United Nations Committee of Experts on the Transport of Dangerous Goods

The United Nations Economic and Social Council’s Committee of Experts on the Transport of Dangerous Goods has developed recommendations for governments and international organizations responsible for the transport of dangerous goods, or its regulation. The development of recommendations was triggered by new technical progress, the advent of new substances and materials, the exigencies of modern transport systems, and, above all, an increasing requirement to ensure the safety of people, property and the environment.

The recommendations do not apply to the bulk transport of dangerous goods in seagoing or inland navigation bulk carriers or tank vessels, which are subject to other international or national regulations.

The recommendations concerning the transport of dangerous goods are presented as an annex to the *United Nations Recommendations on the transport of dangerous goods – model regulations* (United Nations Economic and Social Council’s Committee of Experts on the Transport of Dangerous Goods, 2009). The model regulations present a basic scheme of provisions that will allow uniform development of national and international regulations governing the various modes of transport; yet they remain flexible enough to accommodate any special requirements that might have to be met. It is expected that governments, intergovernmental organizations and other international organizations, when revising or developing regulations for which they are responsible, will conform to the principles of these model regulations, thus contributing to worldwide harmonization. Furthermore, the new structure, format and content should be followed to the greatest extent possible to create a more user-friendly approach, to facilitate the work of enforcement bodies and to reduce the administrative burden. Although only recommendations, the model regulations have been drafted in the mandatory sense (i.e. the word “shall” is used throughout the text rather than “should”). They do not apply to the bulk transport of dangerous goods in sea-going or inland navigation bulk carriers or tank-vessels, which is subject to special international or national regulations.

The model regulations cover principles of classifying and defining classes; listing the principal dangerous goods; general packing requirements; testing procedures, marking, labelling or placarding; and transport documents. In addition, special requirements relate to particular classes of goods. With this system, carriers, consignors and inspecting authorities benefit from simplified transport, handling and control, and from a reduction in time-consuming formalities. In general, obstacles to international transport will be reduced and at the same time the advantages should become increasingly evident as trade in goods categorized as “dangerous” steadily grows.

4.3.6 United Nations Economic Commission for Europe

The *European agreement concerning the international carriage of dangerous goods by road* (ADR) was negotiated in Geneva on 30 September 1957 under the auspices of the United Nations Economic Commission for Europe (UNECE, 2010). It entered into force on 29 January 1968. There are 43 signatories to the ADR, covering countries in the European Union and beyond (e.g. the Russian Federation and the Kingdom of Morocco). The ADR itself is short and simple. The key element states that, apart from some excessively dangerous goods, other dangerous goods may be carried internationally in road vehicles subject to compliance with packaging and labelling conditions for the goods in question (laid down in Annex A), and vehicle construction, equipment and operation conditions (laid down in Annex B). Annexes A and B have been regularly amended and updated since the ADR entered into force. The last amendments entered into force on 1 January 2007 and, subsequently, a revised consolidated version was published – ECE/TRANS/185, Vol. I and II (“ADR 2007”).

The ADR's structure is consistent with that of the *United Nations recommendations on the transport of dangerous goods, model regulations*; the *International maritime dangerous goods code* (of the International Maritime Organization); the *Technical instructions for the safe transport of dangerous goods by air* (of the International Civil Aviation Organization); and the *Regulations concerning the international carriage of dangerous goods by rail* (of the Intergovernmental Organisation for International Carriage by Rail).

4.3.7 Aarhus Convention of the United Nations Economic Commission for Europe

The Convention on Access to Information, Public Participation in Decision-Making and Access to Justice in Environmental Matters (the Aarhus Convention) was adopted on 25 June 1998 in Aarhus, Denmark, at the Fourth Ministerial Conference in the 'Environment for Europe' process. The Aarhus Convention was a new kind of environmental agreement, linking environmental rights and human rights. The convention acknowledges that we owe an obligation to future generations. It establishes that sustainable development can be achieved only through the involvement of all stakeholders, and links government accountability with environmental protection. The subject of the Aarhus Convention goes to the heart of the relationship between people and governments. It is not only an environmental agreement; it is also a convention about government accountability, transparency and responsiveness. The Aarhus Convention grants the public rights and imposes on parties and public authorities obligations regarding access to information, and public participation and access to justice (UNECE, 2000).

4.4 Available guidance

4.4.1 World Health Organization Guidance

The WHO policy paper, *Safe health-care waste management* (WHO, 2004), recommends that countries conduct assessments before choosing health-care management methods. WHO suggests that government organizations adopt the strategies outlined below:

- Short-term strategies
 - Production of all syringe components using the same plastic to facilitate recycling.
 - Selection of polyvinyl chloride-free medical devices.
 - Identification and development of recycling options wherever possible (e.g. for plastic, glass).
 - Research into, and promotion of, new technology or alternative to small-scale incineration.
 - Until countries in transition and developing countries have access to health-care waste-management options that are safer for the environment and health, incineration may be an acceptable response when used appropriately. Key elements of appropriate operation of incinerators include effective waste reduction and waste segregation, placing incinerators away from populated areas, satisfactory engineered design, construction following appropriate dimensional plans, proper operation, periodic maintenance, and staff training and management.
- Medium-term strategies
 - Further efforts to reduce the number of unnecessary injections, to reduce the amount of hazardous health-care waste that needs to be treated.
 - Research into the health effects of chronic exposure to low levels of dioxin and furan.
 - Risk assessment to compare the health risks associated with (a) incineration, and (b) exposure to health-care waste.

- Long-term strategies
 - Effective, scaled-up promotion of non-incineration technologies for the final disposal of health-care waste to prevent the disease burden from (a) unsafe health-care waste management, and (b) exposure to dioxins and furans.
 - Support to countries in developing a national guidance manual for sound management of health-care waste.
 - Support to countries in developing and implementing a national plan, policies and legislation on health-care waste.
 - Promotion of the principles of environmentally sound management of health-care waste as set out in the Basel Convention.
 - Support to allocate human and financial resources to safely manage health-care waste in countries.

WHO also recommends the *Core principles for achieving safe and sustainable management of health-care waste* (WHO, 2007). These principles require that everyone associated with financing and supporting health-care activities should provide for the costs of managing health-care waste. In particular:

- Governments should
 - allocate a budget to cover the costs of establishment and maintenance of sound health-care waste management systems;
 - request donors, partners and other sources of external financing to include an adequate contribution towards the management of waste associated with their interventions;
 - implement and monitor sound health-care waste management systems, support capacity building, and ensure worker and community health.
- Donors and partners should
 - include a provision in their health programme assistance to cover the costs of sound health-care waste-management systems.
- NGOs should
 - include the promotion of sound health-care waste management in their advocacy;
 - undertake programmes and activities that contribute to sound health-care waste management.
- The private sector should
 - take responsibility for the sound management of health-care waste associated with the products and services it provides, including the design of products and packaging.
- All concerned institutions and organizations should
 - promote sound health-care waste management;
 - develop innovative solutions to reduce the volume and toxicity of the waste they produce and that is associated with their products;
 - ensure that global health strategies and programmes take into account health-care waste management.

4.4.2 The International Solid Waste Association

The International Solid Waste Association (ISWA) is recognized as an international, independent and non-profit-making association, working in the public interest to promote and develop sustainable waste management worldwide. ISWA has national and individual members from around the world and promotes sustainable and professional waste management.

4.4.3 ISWA policy document on health-care waste management

ISWA advocates that proper attention is given to the safe and sustainable management of health-care waste and supports the sustainable management of health-care waste by the segregation, storage, transport, treatment and final disposal of health-care waste. It advocates the following principles to its member countries:

- Proper attention is given to sustainable development in the acquisition and use of resources, minimizing resource use where possible, reusing items when appropriate medically, maximizing the recycling of materials, and taking account of sustainable development issues in the management of wastes.
- Each health-care facility has a waste-management plan, which is reviewed regularly, as well as a responsible, properly trained and competence-assessed waste manager. In addition, all staff are trained in the management of waste within a health-care facility.
- Hazardous waste is properly separated from the waste that can be considered municipal solid waste. Hazardous health-care waste is collected and transported within the health-care facility in suitable containers, and is stored in suitable sites not exceeding the recommended duration of 48 hours or less. This may be adjusted by taking into consideration the local climatic conditions. Wastes transported off the site must be in containers that meet the requirements of the *United Nations recommendations on the transport of dangerous goods by road – within Europe*. This is implemented through the ADR.
- Full account is taken of the guidance contained in *Safe management of wastes from health-care activities* (WHO, 1999) and the *Technical guidelines on the environmentally sound management of biomedical and healthcare wastes (Y1; Y3)* (UNEP, 2003). Full account is also taken of the implications of the Stockholm Convention.

ISWA also supports the view that, due to the extensive practice of drug abuse and the growth in the amount of health-care treatment being carried out in the home, proper provisions should be made to ensure that health-care waste from minor sources is captured and treated appropriately.

4.5 National legislation

A national policy document should form the basis for developing the law and should be complemented by technical guidelines developed for implementation of the law. This legal “package” should specify regulations on the treatment of different waste categories; segregation, collection, storage, handling, disposal and transport of waste; and responsibilities and training requirements. The national policy should take into account the resources and facilities available in the country concerned and any cultural aspects of waste handling.

A national law on health-care waste management may stand alone, or constitute part of more comprehensive legislation, such as:

- a law on managing all forms of hazardous wastes, where the application to health-care waste is stated explicitly;
- a law on hospital hygiene and infection control, where a specific section should be devoted to health-care waste.

A national law should include the following elements:

- a clear definition of hazardous health-care waste and its various categories;
- a precise indication of the legal obligations of the health-care waste producer regarding safe handling and disposal;
- specifications for record keeping and reporting;
- establishment of permit or licensing procedures for systems of treatment and waste handling;
- specifications for an inspection system and regular audit procedures to ensure enforcement of the law and for penalties to be imposed for contravention;
- designation of courts responsible for handling disputes arising from enforcement of, or non-compliance with, the law.

Gradual implementation of the law is recommended in preference to any attempt to introduce all measures simultaneously, particularly where existing practices are inadequate.

4.6 Technical guidelines

Technical guidelines intended to aid the implementation of legislation should be practical and directly applicable to local managers and staff. They should contain sufficient detail to ensure that safe practices and appropriate standards can be achieved. They should outline the legal framework to be met for the safe management of health-care waste and how the guidance improves hospital hygiene, and occupational health and safety. Technical guidelines can be prepared by various organizations, both public and nongovernmental, and collectively address a broad range of relevant topics:

- responsibilities of public health authorities
- safe practices for waste minimization
- separation, handling, storage and transport of health-care waste
- treatment and disposal methods for each category of health-care waste and for wastewater
- limits of emission of atmospheric pollutants and measures for protection of water resources.

An example of national technical guidelines is contained in *Health technical memorandum 07-01: safe management of health care waste* (UK DoH, 2006).

4.7 Minimum approach to developing health-care waste-management policy

Where there is no national policy, legislation or guidelines, this should not prevent a hospital or health-care facility from commencing a modest programme of health-care waste management. A short document could be prepared that states the problems, sets out simple actions, identifies the stakeholders, and mobilizes them to carry out the actions. Initially, this is all that may be necessary. A number of publications can assist in preparing a health-care waste-management system and training programme for staff. The following two example publications can be downloaded from the internet:

- *Starting health care waste management in medical institutions* (WHO, 2000), available at http://www.healthcarewaste.org/fileadmin/user_upload/resources/HCW_practicalInfo1.pdf
- *Preparation of national health care waste management plans in sub-Saharan countries: guidance manual* (WHO, 2005), available at http://www.who.int/water_sanitation_health/medicalwaste/guidmanual/en/.

The success of a practical health-care waste-management plan in one hospital will often influence other hospitals. It may also encourage national governments subsequently to devise the necessary national policy and framework.

4.8 Desirable improvements to the minimum approach

A number of desirable improvements should be considered when setting policy and legislation. These are to:

- set a national budget to ensure that the regulations are fully complied with, and require that individual establishments do the same;
- continually improve the mandatory standards of health-care waste management;
- create an organized system of enforcement of the legislation;
- create a national system of training and assessment of technical competence in the management of health-care waste;
- create a system of awareness raising, training and regular assessment of sustainable development in the management of all wastes produced in health-care facilities.

Key points to remember

A national policy document should outline the rationale for the legislation, taking account of international agreements and conventions that the country may be a signatory to, plus a set of national goals to be achieved and the steps necessary to achieve them. A policy document may contain:

- definitions of the various waste streams produced in health-care facilities;
- promotion of the advantages of sustainable segregation and storage techniques for the different waste streams;
- descriptions of the health and safety risks resulting from mismanagement of health-care waste;
- reasons for sound, sustainable and safe health-care waste-management practices in health-care establishments;
- listing of approved methods of treatment and disposal for each waste category;
- warning against unsafe practices, such as disposing of hazardous health-care wastes in an uncontrolled manner;
- descriptions of management responsibilities within and outside health-care facilities;
- assessment of the costs of health-care waste management;
- key steps to implement in health-care waste management: minimization, separation, handling, transport, treatment and final disposal;
- technical specifications for the implementation of each step (described in separate technical guidelines);
- descriptions of record keeping and documentation;
- training requirements;
- rules governing the protection of workers' health and safety.

Once the policy on the management of health-care waste has been agreed, national legislation should then be developed based upon the policy. It should establish national legal controls and allow a national environmental protection agency, health body or similar organization responsible for the regulation of health-care waste management to encourage their implementation. The legislation should also prescribe penalties for non-compliance with the law.

A lack of clarity causes confusion, so it is very important that there are clear lines of responsibility for the management and regulation of health-care waste between government departments and agencies responsible for health, environment and occupational safety.

Technical guidelines associated with the legislation should be practical and directly applicable in health-care facilities. They should include the specifications, with sufficient detail to ensure that safe practices are observed and appropriate standards can be achieved.

Where there is no national commitment to improving health-care waste management, then individual hospitals and clinics should adopt improvements themselves. The success of a practical health-care waste-management plan in one hospital will often influence other hospitals. It may also encourage national governments subsequently to devise the necessary national policy and framework.

4.9 References and further reading

References

UK DoH (United Kingdom Department of Health) (2006). *Health technical memorandum 07-01: safe management of health care waste*. London, United Kingdom Department of Health (http://www.dh.gov.uk/en/Publicationsandstatistics/Publications/PublicationsPolicyAndGuidance/DH_063274).

UNECE (United Nations Economic Commission for Europe) (2000). *The Aarhus Convention: an implementation guide*. New York and Geneva, United Nations (<http://www.unece.org/env/pp/acig.pdf> and <http://www.unece.org/env/pp/welcome.html>).

UNECE (2010). *European agreement concerning the international carriage of dangerous goods by road: ADR* (Economic Commission for Europe). Geneva, United Nations.

UNEP (United Nations Environment Programme) (1972). *Report of the United Nations Conference on the Human Environment*, Stockholm, 5–16 June 1972. United Nations publication No. E.73.II.A.14. Geneva, United Nations (<http://www.unep.org/Documents.Multilingual/Default.asp?documentid=78&articleid=1163>).

UNEP (2003). *Technical guidelines on the environmentally sound management of biomedical and healthcare wastes (Y1;Y3)*. Geneva, United Nations Environment Programme (<http://www.basel.int/TheConvention/Publications/TechnicalGuidelines/tabid/2362/Default.aspx>).

UNEP (2006). *Guidelines on best available techniques and provisional guidance on best environmental practices relevant to Article 5 and Annex C of the Stockholm Convention on Persistent Organic Pollutants*. Geneva, Secretariat of the Stockholm Convention (http://www.pops.int/documents/guidance/batbep/batbepguide_en.pdf).

United Nations Economic and Social Council's Committee of Experts on the Transport of Dangerous Goods (2011). *Recommendations on the transport of dangerous goods*, 16th rev. ed. UNECE, Geneva (http://www.unece.org/trans/danger/publi/unrec/rev17/17files_e.html).

World Commission on Environment and Development (1987). *Our common future*. Oxford, Oxford University Press.

WHO (2000). *Starting health care waste management in medical institutions*. Geneva, World Health Organization (http://www.healthcarewaste.org/fileadmin/user_upload/resources/HCW_practicalInfo1.pdf)

WHO (2004). *Safe health care waste management: policy paper*. Geneva, World Health Organization (http://www.who.int/water_sanitation_health/medicalwaste/hcwmpolicy/en/index.html).

WHO (2005). *Preparation of national health care waste management plans in sub-Saharan countries: guidance manual*. Geneva, World Health Organization and United Nations Environment Programme Secretariat of the Basel Convention (http://www.who.int/water_sanitation_health/medicalwaste/guidmanual/en).

WHO (2007). *WHO core principles for achieving safe and sustainable management of health-care waste*. Geneva, World Health Organization (http://www.who.int/water_sanitation_health/medicalwaste/hcwprinciples/en/index.html).

Further reading

ISWA (International Solid Waste Association) (2007). *Technical policy paper No.11 – Health care waste*. Copenhagen, International Solid Waste Association (<http://www.iswa.org/en/76/publications.html>).

Rushbrook PE, Chandra C, Gayton S (2000). *Starting health care waste management in medical institutions: a practical approach*. Copenhagen, Health Care Waste Practical Information Series, No. 1. World Health Organization Regional Office for Europe (http://www.healthcarewaste.org/fileadmin/user_upload/resources/HCW_practicalInfo1.pdf).

Secretariat of the Basel Convention (2011). *Technical guidelines on environmentally sound management of wastes consisting of elemental mercury and wastes containing or contaminated with mercury* (31 October 2011). Geneva, Basel Convention and United Nations Environment Programme (<http://www.basel.int/Implementation/TechnicalMatters/DevelopmentofTechnicalGuidelines/MercuryWaste/tabid/2380/Default.aspx>).

United Nations Commission on Sustainable Development (2002). *Plan of implementation of the World Summit on Sustainable Development*, paragraphs 19, 22 and 23. Geneva, United Nations (<http://www.un-documents.net/jburgpln.htm>).

WHO (World Health Organization) (2002). *Basic steps in the preparation of health care waste management plans for health care establishments*. Amman, WHO Centre for Environmental Health Activities (<http://www.k4health.org/toolkits/implants/basic-steps-preparation-health-care-waste-management-plans-health-care>).

WHO (2005a). *Better health care waste management*. Amman, WHO Regional Office for the Eastern Mediterranean, Regional Centre for Environmental Health Activities.

WHO (2005). *Mercury in health care*. Geneva, World Health Organization (http://www.who.int/water_sanitation_health/medicalwaste/mercury/en/index.html).

5

Health-care waste-management planning

Key questions to answer

What is the purpose of planning for health-care waste management?

What are the basic steps to prepare a national plan and a local plan for a health-care facility?

Who should be the members of a health-care waste-management team?

What topics should be included in a waste-management plan?

What should be the minimum level of health-care waste planning for lower income areas?

5.1 The need for planning

Health-care waste-management operations at local, regional and national levels should be organized and planned. Piecemeal implementation is not the most persuasive or effective way to sustain improvements or to replicate them throughout a hospital or district or country. A good plan is a good basis to explain what needs to be done and to coordinate the roles of the many people involved.

Planning defines the strategy for the implementation of improved waste management and the allocation of roles, responsibilities and resources. A well-thought-out plan describes the actions to be implemented by authorities, health-care personnel and waste workers. At the national level, a plan is critical for government to define its intentions to make improvements, and the resources required across the country for successful implementation.

Planning for health-care waste management at national, regional or local levels should take into consideration the World Health Organization (WHO) core principles for achieving safe and sustainable management of health-care waste (WHO, 2007a). The WHO core principles require that all personnel associated with financing and supporting health-care activities should provide for the costs of managing health-care waste. This is the duty of care. Manufacturers also share a responsibility to take waste management into account in the development and sale of their products and services.

The core principles provide guidance on a clear delineation of responsibilities and funding that takes place chiefly at the planning stage. Planning should cover the six objectives listed below (WHO, Basel Convention & UNEP, 2005):

- develop the legal and regulatory framework for health-care waste management
- rationalize the waste-management practices within health-care facilities
- develop specific financial investment and operational resources dedicated to waste management
- launch capacity building and training measures
- set up a monitoring plan
- reduce the pollution associated with waste management.

As health-care waste management is an evolving field, the planning process should allow for periodic updates to policies as improvements in processes and technology become known.

Plans developed for the local level should be more detailed, with an assessment of needs, difficulties to be overcome, materials needed, skills available, costs, and the waste-handling methods and treatment options available. A local-level plan can also be used to explain the benefits from better waste management.

A larger health-care facility should aim to establish a formal waste-management plan. This is a document that contains the combined knowledge and decisions for all involved in the production, handling and treatment of wastes. A senior person at a health-care facility should be chosen and made responsible for preparing the plan, collecting ideas from others and, once agreed, promoting the way health-care waste should be managed to medical and ancillary staff. At a smaller medical centre, the local plan would be a shorter description of the waste-management arrangements that should be put in place in each medical area, as well as identifying who is responsible for good practices in each area, where the waste will go, and how it should be disposed of after it has been removed by a cleaner or porter.

5.2 National plans

5.2.1 Purpose of a national health-care waste-management plan

A national management plan should be based on an assessment of the health-care waste-management options available and then reach consensus on the related actions to be implemented across the country. A national survey of existing health-care practices and technologies in use should precede a planning exercise. It provides the data to allow realistic plans to be produced that inform government decision-making on the development of new treatment facilities, the regulations and guidance required, and the level of funds necessary to implement a national plan.

5.2.2 Action plan for developing a national programme

In ideal situations, a national programme of health-care waste management can be pursued to give sustained political support and structure to the preparation of a national plan. This is an organized approach involving stakeholders from the health, industry and public sectors to develop a workable waste policy; provide direction for the preparation of new guidance and standards for the health sector; reinforce the benefits to public health from controlling wastes and training staff; and indicating the location and design criteria for future waste-treatment and disposal facilities. WHO has defined an example action plan comprising eight steps (Figure 5.1).

Step 1 Establish policy commitment and responsibility for health-care waste management

Before an action plan is developed and implemented, there needs to be political commitment to prepare a national policy on health-care waste management. Thereafter, responsibility to prepare the plan is delegated to an appropriate government authority. The ministry of health or the ministry of environment usually serves as the principal authority and should be required to work closely with others, such as ministries, health organizations, private-sector service providers, nongovernmental organizations (NGOs) and professional bodies. It should be recognized that, at the outset, any policy commitment by a government to improve health-care waste management will have cost implications, and this should be reflected in the preparation of cost estimates on the financing necessary to fulfil the national plan.

Step 2 Conduct a national survey of health-care waste management practices

The national agencies responsible for the issue of health-care waste should be fully aware of current levels of waste production and of national waste-management practices. A survey is essential for planning an effective waste-management programme. To be comprehensive, data should be collected not only from managers and officials but also from front-line workers. A survey should include both impartial site observations and interviews with health-care managers and medical and support staff (e.g. cleaners, waste handlers) at different levels. A standard data-gathering questionnaire should be prepared to capture data consistently and used at all (or a representative sample of) health-care facilities.

A useful assessment should include the following:

- An inventory of existing health facilities – this can be used as a database on the distribution of health-care facilities, the medical services provided, the numbers of patients treated and the standards of service achieved.
- An analysis of existing legislation – this is crucial for the planning process, because it defines the amount and type of legal obligations mandated and highlights any deficiencies in legal and regulatory requirements expected of public bodies, the private sector and individuals for the safe handling of health-care waste. It is also a point of reference to determine existing responsibilities for waste management and public safety.
- An estimate of health-care waste production nationwide – a waste-generation survey provides essential data on the quantities and types of waste produced and a comparison of the rates of generation between health-care facilities and regions. Typical approaches to comparisons between medical areas and health-care waste facilities are to express the waste quantities against the number of hospital beds, bed occupancy rate, or number of outpatients treated per day or per month.
- A description of health-care waste-management practices – often, central government does not have clear information on the waste practices in use. This information can be gathered by observing staff in hospitals and clinics. Collecting these data is essential so that realistic decisions can be made on where to prioritize interventions according to the magnitude of the risks posed by present methods. The kind of qualitative information that can be collected includes
 - skills and knowledge of personnel involved in the management of health-care waste;
 - current health-care waste-disposal practices, including level of health protection achieved from existing segregation, collection, transportation, storage and disposal methods.
- An analysis of the availability of training for staff in central authorities and at individual health-care facilities.
- An analysis of the institutional and monitoring capacities – this is used to show if, or how, the safe disposal of waste is monitored and quality checked.

Table 5.1 provides an example survey questionnaire, which has been used to identify issues that require interventions in a survey of hospitals in WHO's South-East Asia Region. Other assessment tools also exist, and are useful for costing and assessing progress when implementing a new plan:

- *Health care waste management rapid assessment tool* (WHO, 2004; currently being updated).² This assessment tool helps to provide an overall picture of health-care waste management within a country at all levels (from the ministerial level down to small health-care facilities). The tool can be used to assess management, training, regulatory, technical and financial issues, which helps to pinpoint critical issues that need to be addressed within the framework of a national action plan.
- *Health care waste management assessment tool* (WHO, 2000). This WHO electronic tool provides a quick snapshot of country progress in health-care waste and focuses on injection waste as a major, high-risk component of the health-care waste stream.
- *Health care waste management – Expanded costing analysis tools* (WHO, 2007b). The expanded costing analysis helps the user estimate costs related to health-care waste management at the health-care facility, central treatment facility or cluster, and national levels (see Chapter 10 for more details).³

The WHO health-care waste-management website provides further information.⁴

Step 3 Develop national guidelines

Technical guidelines are the foundation for a national programme of improvement for health-care waste management, together with a realistic legal framework that supports them. Step 3 consists of the formulation of a national policy document based on the results of the national survey, and identification of new practical guidance that needs to be prepared. The two may be brought together in one comprehensive document.

2 See <http://www.healthcarewaste.org/en/documents.html?id=115&suivant=20>

3 See <http://www.healthcarewaste.org/en/documents.html?id=218&suivant=19>

4 See http://www.who.int/water_sanitation_health/en

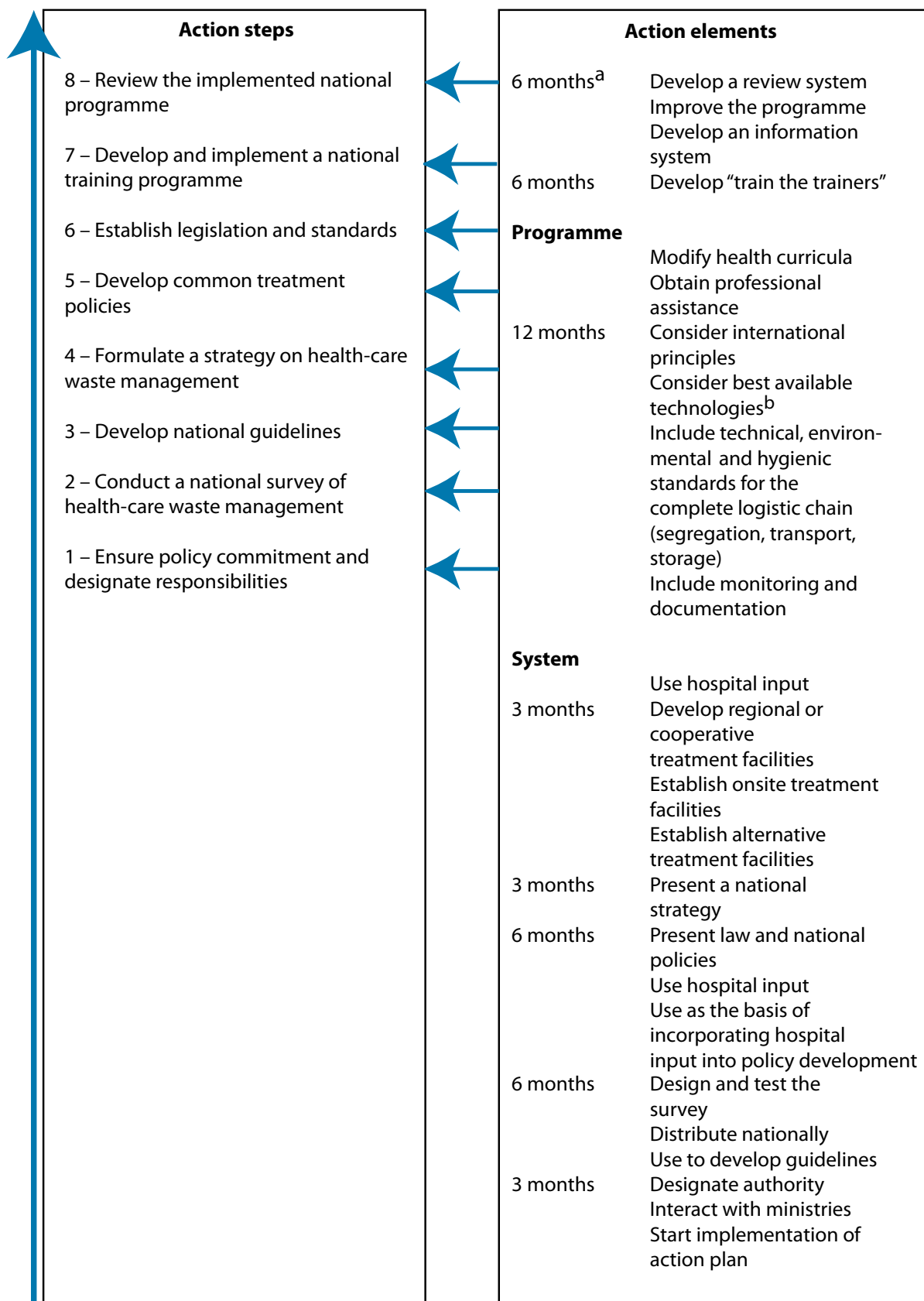

^a Time (months) to complete action

^b Best available technologies (BAT) are the international standards

Source: Adapted from WHO (1997)

Figure 5.1 Action plan for national programme of sound health-care waste management

Step 4 Formulate a national strategy on health-care waste management

Drawing on the intentions presented in the national policy, a government then must turn its policy objectives into tangible changes within the health-care sector. It is common practice for a ministry or central authority to develop a national implementation strategy. This national strategy should:

- set goals and the means of monitoring infection control and environmental protection;
- provide an optimal selection of technologies for packaging, transportation, treatment and disposal;
- identify appropriate options for centralized and local waste-disposal systems;
- reflect distribution of responsibility in the sector among central, regional and local authorities;
- propose guidance for training programmes at health-care facilities at municipal, regional and country levels;
- provide guidance for setting up a monitoring and documentation system on health-care waste management;
- draw up an action plan for implementing improved waste practices;
- provide a costed investment plan describing the capital, annual operation and maintenance finance estimated to be needed to implement the national strategy.

Step 5 Develop a policy on regional and cooperative methods of health-care waste treatment

Ideally, a government should identify the resources needed to build up a national network of disposal facilities for health-care waste, accessible by hospitals and other health-care facilities. At present, there are four basic options for managing health-care waste treatment:

- Option 1: an onsite treatment facility in each health-care establishment;
- Option 2: regional or cooperative health-care waste-treatment facilities, supplemented by individual facilities for outlying hospitals;
- Option 3: treatment of health-care waste in existing industrial or municipal treatment facilities (e.g. municipal facilities), where these exist;
- Option 4: partial treatment undertaken onsite, and remaining waste treated offsite.

Each option has advantages and disadvantages, and the suitability of each option should be considered in a national plan. A national or regional plan should account for local circumstances, such as the number, location, size and type of health-care establishments, quality of the road network, and financial and technical resources available in each area.

Step 6 Establish legislation: regulations and standards for health-care waste management

Once developed, a national plan and related guidelines are usually supported by legislation to regulate their application. Waste-management laws are usually based on widely accepted principles contained in various international agreements to which a country is a signatory (see Chapter 4).

Step 7 Institute a national training programme

To achieve acceptable practices in health-care waste management, all managers and other personnel must receive appropriate training. In addition, training programmes are necessary for achieving national health expectations, and for complying with regulations. Developing a health-care waste-management training programme could begin with short training for staff and officials, longer courses for staff and officials, longer courses to train future trainers and refresher courses for experienced staff. Institutions at national, regional or local levels could assist in preparing “training the trainers” activities and identify competent institutions or centres for the training programme. Details on training programmes are provided in Chapter 13 and Annex 2.

Step 8 Review the national health-care waste-management programme after implementation

A national programme for health-care waste management should be viewed as a continuous process with periodic monitoring and reassessment by a responsible national government agency, such as a public health, sanitation or environmental agency. In addition, the recommendations on treatment methods should be regularly updated to keep pace with new developments. The national agency should base its assessment primarily on reports from hospitals and clinics on their success in implementing waste-management plans. It should review annual reports submitted by the heads of the facilities and make random visits to carry out audits of the waste-management systems. Any deficiencies in the waste-management system should be pointed out to the hospital or clinic director in writing, together with recommendations for remedial measures. Where practicable, a time limit for implementing remedial measures should be specified and the head of the establishment should be informed of the date of a follow-up visit.

Offsite waste-treatment facilities, operators of treatment facilities, road-haulage contractors and landfill operators should also be audited. Periodic reviews of waste-management operators by both a national government agency and the health-care facilities that use them should be expected. These latter two bodies should also be expected to press for improvements in the protection of occupational and public health from waste operations.

5.3 Waste-management plan for a health-care facility

5.3.1 Assignment of responsibilities

The effective management of health-care waste is one aspect of the continuous need to control infections. Health-care waste management should be viewed as part of infection control, and a local waste-management plan could be developed by infection-control staff where they are present. In the larger health-care facilities where large quantities of waste are generated, a separate waste-management group or committee may be formed instead.

A typical waste-management committee in a large hospital may contain the following members:

- head of hospital (as chairperson)
- heads of hospital departments
- infection-control officer
- chief pharmacist
- radiation officer
- matron (or senior nursing officer)
- hospital manager
- hospital engineer
- financial controller
- waste-management officer (if one is designated).

In larger establishments, the structure may include a specialist hospital hygienist, in addition to, or instead of, the infection-control officer, to address persistent difficulties relating to hospital hygiene, such as persistent methicillin-resistant *Staphylococcus aureus* or *Clostridium difficile* contamination.

In health-care facilities in lower income areas, the suggested approach is to have a smaller infection-control committee with one person responsible for health-care waste management.

The head of hospital should formally appoint the members of the waste-management team in writing, informing each of their duties and responsibilities (outlined in the following sections). The head should appoint a waste-management officer who will have overall responsibility for developing the health-care waste-management plan, and for the day-to-day operation and monitoring of the waste-disposal system. Depending on availability of

relevant staff, this post may be assigned to the hospital engineer, hospital manager, or any other appropriate staff member at the discretion of the head of hospital.

In an institution that is not directly involved in patient care, such as a medical research institution, the head of the establishment should use their discretion to appoint members of the waste-management team from among the relevant staff.

5.3.2 Management structure, liaison arrangements and duties

A typical hospital waste-management structure is shown in Figure 5.2, with line-management responsibilities and liaison paths between key personnel involved in handling health-care waste. This structure may be adjusted to the particular needs of each hospital. Key personnel in large hospitals can share duties (as described in the following paragraphs), while one person can fulfil two or more sets of responsibilities in smaller health-care facilities.

Head of hospital

The head of hospital is responsible for the following tasks:

- Form a waste-management team to develop a written waste-management plan for the hospital. The team should consist of representatives from clinical and non-clinical areas of the organization, in addition to those who are involved in the removal and management of waste. The plan should clearly define the duties and responsibilities of all members of staff, both clinical and non-clinical, in respect to handling health-care waste and to establishing lines of accountability.
- Oversee and approve a waste-management plan.
- Designate a waste-management officer to supervise and implement the waste-management plan. The head of hospital retains overall responsibility for ensuring that health-care and other wastes are disposed of according to national guidelines.
- Keep the waste-management plan updated by setting regular (e.g. annual) review dates.
- Allocate financial and personnel resources to ensure efficient operation of the plan. For example, sufficient staff should be assigned to the waste-management officer to ensure efficient operation of the waste-management plan.
- Ensure that monitoring procedures are incorporated in the plan. The efficiency and effectiveness of the treatment and disposal system should be monitored so that the system can be updated and improved when necessary. Any changes should eventually be incorporated into a revised management plan.
- Appoint a successor in the event of personnel leaving key positions in the waste-management team (or temporarily assign responsibility to another staff member until a successor can be appointed).
- Ensure adequate training for staff members, and designate the staff responsible for coordinating and implementing training courses.

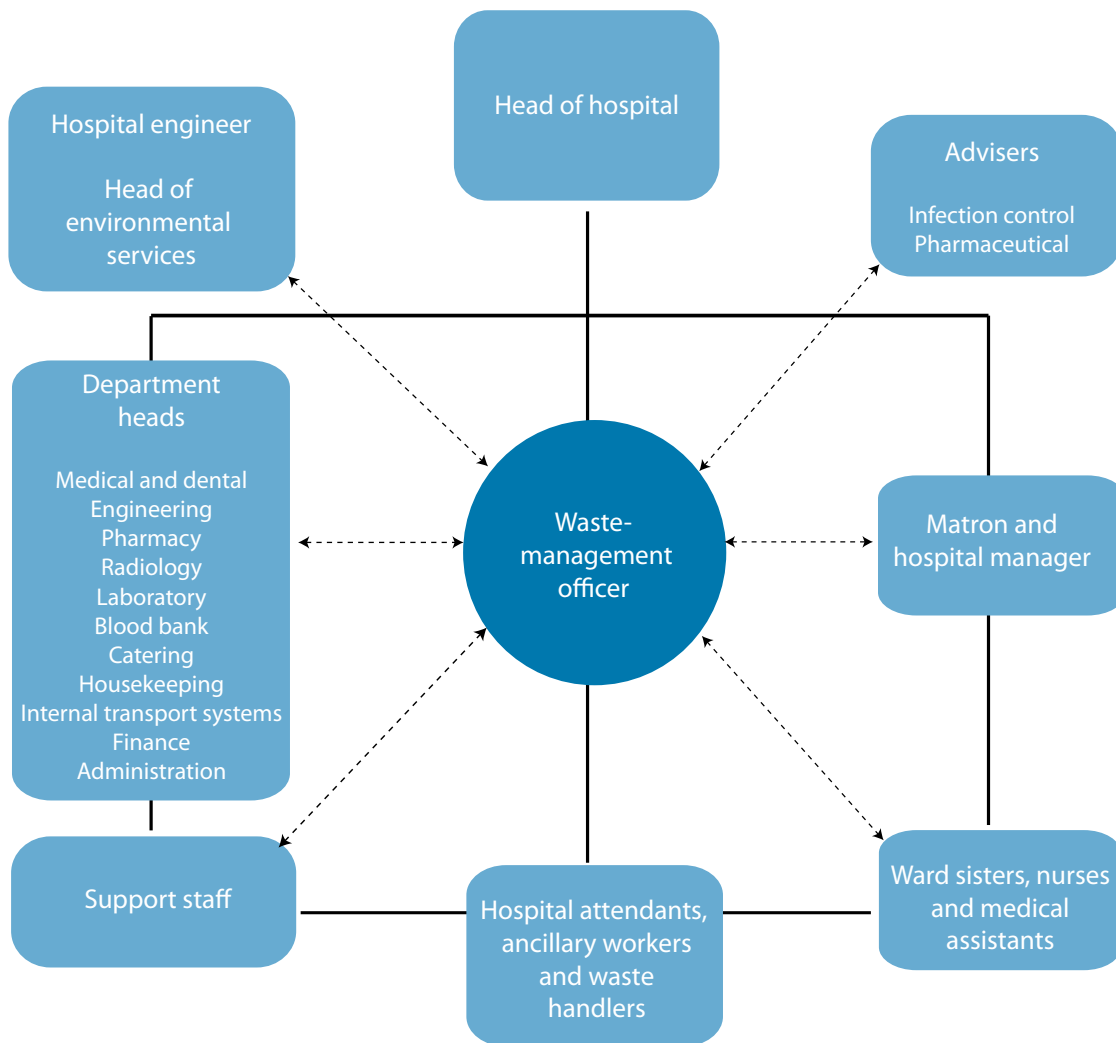

Note: Liaison paths are represented by dotted lines. Line-management paths are represented by solid lines.
 Source: Adapted from WHO WPR (1994)

Figure 5.2 Hospital waste-management structure

Waste-management officer

The waste-management officer is responsible for the day-to-day operation and monitoring of the waste-management system and is usually established as a separate post at larger hospitals. It is therefore important that the waste-management officer has direct access to all members of the hospital staff (see Figure 5.2). The role should be held by a senior member of staff and should be responsible to the head of hospital. The waste-management officer should liaise with the infection-control officer, the chief pharmacist and the radiation officer so that they become familiar with the correct procedures for handling and disposing of pathological, pharmaceutical, chemical and radioactive wastes.

To manage waste collection, storage and disposal, the waste-management officer should:

- control internal collection of waste containers and their transport to the central waste-storage facility of the hospital on a daily basis;
- liaise with the supplies department to ensure that an appropriate range of bags and containers for health-care waste, protective clothing and collection trolleys is available at all times;
- ensure that hospital attendants and ancillary staff immediately replace used bags and containers with the correct new bags or containers;

- directly supervise hospital attendants, ancillary workers and waste handlers assigned to collect and transport health-care waste;
- ensure the correct use of the central storage facility for health-care waste, which should be kept locked but should always be accessible to authorized hospital staff;
- prevent all unsupervised dumping of waste on the hospital grounds;
- coordinate and monitor all waste-disposal operations;
- monitor methods of transportation of wastes both onsite and offsite, and ensure that wastes collected from the hospital are transported by an appropriate vehicle to the designated treatment and disposal site;
- ensure that waste is not stored for longer than specified in the guidelines and that the transport organization (which may be the local authority or a private contractor) collects the waste with the required frequency.

To organize staff training and information, the waste-management officer should be responsible for the following actions:

- Liaise with the matron (or senior nursing officer) and the hospital manager to ensure that the nursing staff and medical assistants are aware of their own responsibilities for the segregation and storage of waste, as well as for the correct closing and sealing of bags and containers. The waste-management officer also defines the duties of hospital attendants and ancillary staff on the handling and transport of sealed waste bags and containers.
- Liaise with department heads to ensure that all doctors and clinical staff are aware of their own responsibilities regarding waste segregation, and storage and closing and sealing of waste bags, to minimize infection risks, as well as the responsibilities of hospital attendants and ancillary staff regarding the handling and transport of sealed bags and containers.
- Ensure that waste handlers are properly trained in waste collection and treatment, as well as safe and sufficient disposal methods, including how to operate and maintain machines and technology. Refresher courses should be provided on a routine basis.
- Ensure compliance with occupational health measures, including current practices for post-exposure prophylaxis, as well as the provision and use of personal protective equipment for health workers and waste handlers.

To prepare for incident management and control, the waste-management officer should:

- ensure that written and pictorial emergency and contingency procedures are available, that they are in place at all times, and that personnel are aware of the action to be taken in the event of an emergency;
- investigate and review any reported incidents concerning the handling of health-care waste (in liaison with the infection-control department).

In addition, the waste-management officer should continuously monitor certain parameters, which are listed in Box 5.1.

Department heads

Department heads are responsible for the segregation, storage and disposal of waste generated in their departments. They should:

- ensure that all doctors, nurses, and clinical and non-clinical professional staff in their departments are aware of the segregation, sealing and storage procedures, and that all personnel comply with the highest standards;
- liaise regularly with the waste-management officer to monitor working practices for failures or mistakes;
- ensure that key staff members in their departments are trained in waste segregation and disposal procedures;
- encourage medical and nursing staff to be vigilant so as to ensure that hospital attendants and ancillary staff follow correct procedures at all times.

Matron and hospital manager

The matron (or senior nursing officer) and the hospital manager are responsible for training nursing staff, medical assistants, hospital attendants and ancillary staff in the correct procedures for segregation, sealing, storage, transport and disposal of waste. They should:

- liaise with the waste-management officer and the advisers (infection-control officer, chief pharmacist and radiation officer) to maintain high standards of infection control;
- participate in staff induction and refresher training in the handling and treatment and disposal of health-care waste;
- liaise with department heads to ensure coordination of training activities, and decide what to do about waste-management issues specific to particular departments.

Box 5.1 Parameters to be monitored by the waste-management officer

Waste generated each month, by waste category:

- in each department
- treatment and disposal methods.

Waste handled safely and in accordance to the safety operation procedures:

- occupational safety (e.g. personal protective equipment)
- use of proper and clean equipment and marking equipment
- proper segregation at source
- internal safe transport and storage
- internal safe treatment methods
- safe disposal methods if on premises of the health-care facility.

Financial aspects of health-care waste management:

- direct costs of supplies and materials used for collection, transport, storage, treatment, disposal, decontamination and cleaning
- training costs (labour and material)
- costs of operation and maintenance of onsite treatment facilities
- costs for contractor services.

Public health aspects:

- Incidents resulting in injury, “near misses” or failures in the handling, segregation, storage, transport or disposal system should be reported to the infection-control officer and the waste-management officer. This information should be used to decide the preventive measures to avoid recurrences.

Infection-control officer

The infection-control officer should liaise with the waste-management officer on a continual basis, and provide advice about the control of infection, and the standards of the waste treatment and disposal system. The infection-control officer’s duties that relate to health-care waste include:

- identifying training requirements according to staff grade and occupation
- organizing and supervising staff training courses on the infection risks from poor waste management
- liaising with the department heads, the matron and the hospital manager to coordinate training.

The infection-control officer may also have overall responsibility for chemical disinfection, the safe management of chemical stores, and minimizing chemical waste creation.

Chief pharmacist

The chief pharmacist is responsible for the safe management of pharmaceutical stores and for minimizing pharmaceutical waste. Duties include:

- liaising with department heads, the waste-management officer, the matron and the hospital manager, and giving advice, in accordance with the national policy and guidelines, on the appropriate procedures for pharmaceutical waste treatment and disposal;
- coordinating continual monitoring of procedures for the treatment and disposal of pharmaceutical waste;
- ensuring that personnel involved in pharmaceutical waste handling, treatment and disposal receive adequate training;
- remaining up to date with the proper treatment and safe disposal of expired, damaged and unusable pharmaceuticals, pharmaceutical packaging and equipment.

The chief pharmacist also has the special responsibility of ensuring that genotoxic products are used safely, and that genotoxic waste is managed safely.

Radiation officer

The duties and responsibilities of the radiation officer are the same as those of the pharmaceutical officer but relate to radioactive waste. There may also be additional regulations regarding the storage and safeguarding of radioactive wastes. These regulations need to be followed strictly for the safety of those handling the wastes.

Supply officer

The supply officer should liaise with the waste-management officer to ensure a continuous supply of the items required for waste management (plastic bags and containers of the right quality, spare parts for onsite health-care waste-treatment equipment). These items should be ordered in good time to ensure that they are always available, but accumulation of excessive stores supplies should be avoided. The supply officer should also investigate the possibility of purchasing environmentally friendly products (e.g. polyvinyl chloride-free plastic items).

Hospital engineer

The hospital engineer is responsible for installing and maintaining waste-storage facilities and handling equipment that comply with the specifications of the national guidelines. The engineer is also accountable for the adequate operation and maintenance of any onsite waste-treatment equipment, and is responsible for the staff involved in waste treatment, ensuring that:

- staff receive training in the principles of waste disposal and are aware of their responsibilities under the hospital waste-management plan;
- staff operating onsite waste-treatment facilities are trained in their operation and maintenance.

5.3.3 Assessment of waste generation

To develop a waste-management plan, the waste-management team should assess all waste generated in the hospital. The waste-management officer should be responsible for coordinating such a survey and for analysing the results. The waste should be categorized according to the classification system specified in the national guidelines (or as described in this handbook, if no such guidelines are available). The survey should determine the average daily quantity of waste in each category generated by each hospital department.

The waste-management team should take special care to test the robustness of the waste-management plan during periods of “peak” waste production – the occasional generation of extraordinary quantities of wastes. For example, the waste-management plan should be able to plan for the impact of epidemics, the introduction of new medical procedures, seasonal illnesses (such as influenza outbreaks) and emergencies that affect the quantities of waste

generated. The waste-management plan should also take into account potential slack periods or other unusual circumstances that may significantly reduce waste quantities. Surveys can be used to help plan for these periods of higher or lower waste generation; for example, survey results can sometimes be used to predict future changes in hospital capacity or the establishment of new departments. Table 5.1 shows a sample sheet for the daily assessment of waste, by waste category, for each waste-collection point. The survey system for the waste-production survey could form the basis for routine waste-generation record keeping in each medical area.

5.3.4 Development of a hospital waste-management plan

During development of the waste-management plan, every member of the waste-management committee should review existing waste-management arrangements in their area of responsibility. Existing practices should then be evaluated in the light of the national guidelines and recommendations made to the waste-management officer on how the guidelines can be implemented in each area. On the basis of the waste-generation survey and these recommendations, the waste-management officer should prepare a draft discussion document for the waste-management committee. This discussion document should include details of changes to the present waste-management system (as outlined in Box 5.2) and should contain sections addressing the following issues:

- present situation (waste-management practices, personnel and equipment involved);
- quantities of waste generated;
- possibilities for waste minimization, reuse and recycling; waste segregation; onsite handling, transport and storage practices;
- identification and evaluation of waste-treatment and disposal options (onsite and offsite);
- identification and evaluation of the options for record keeping and documentation, training and monitoring;
- estimation of costs relating to waste management, including capital, operational and maintenance costs;
- strategy for implementing the plan.

Table 5.1 Sample sheet for assessing waste generation

Name of the health-care facility: Week:															
Waste-collection point: department/ location	Waste category ^a (specify)	Quantity of waste generated per day (weight and volume)													
		Monday		Tuesday		Wednesday		Thursday		Friday		Saturday		Sunday	
		kg	litre	kg	litre	kg	litre	kg	litre	kg	litre	kg	litre	kg	litre

^a Infectious waste, pathological waste, sharps, pharmaceutical waste, cytotoxic waste, waste with high heavy metal content, radioactive waste
Source: adapted from Christen (1996)

A draft discussion document should be prepared in consultation with all members of the waste-management committee and their staff. Officials from the local municipality and perhaps the national government agency responsible for the disposal of health-care wastes should be invited to assist in the planning process.

Subsequently, a waste-management plan would be based on an expanded version of the discussion document and should be presented to the waste-management committee for approval. When full agreement has been reached, the document should be designated as the hospital waste-management plan.

The waste-management plan should include diagrams that outline the line-management structure and the liaison paths between managers and staff, and a list of names and telephone numbers of responsible personnel to be notified in the event of an emergency. The waste-management plan should also include a clear set of actions for implementing the plan across the health-care facility.

Box 5.2 Details to include in the waste-management plan

Location and organization of collection and storage facilities

1. Drawings of the establishment showing designated bag or disposal container for every ward and department in the hospital; disposal container shall be appropriately designated for health-care waste or other waste.
2. Drawings showing the central storage site for health-care waste and the separate site for other waste. Details of the type of containers, security equipment, and arrangements for washing and disinfecting waste-collection trolleys (or other transport devices) should be specified. The document should also address eventual needs for refrigerated storage facilities.
3. Drawings showing the paths of waste-collection trolleys through the hospital, with clearly marked individual collection routes.
4. A collection timetable for each trolley route, the type of waste to be collected, and the number of wards and departments to be visited on one round. The central storage point in the facility for that particular waste should be identified.

Design specifications

1. Drawings showing the type of bag holder to be used in the wards and departments.
2. Drawings showing the type of trolley or wheeled container to be used for bag collection.
3. Drawings of sharps containers, with their specification.

Required material and human resources

1. An estimate of the number and cost of bag holders and collection trolleys.
2. An estimate of the number of sharps containers and health-care waste drum containers required annually, categorized into different sizes, if appropriate.
3. An estimate of the number and cost of colour-coded bags or bins to be used annually.
4. An estimate of the number of personnel required for waste collection.

Responsibilities

1. Definitions of responsibilities, duties and codes of practice for each of the different categories of personnel of the hospital who, through their daily work, will generate waste and be involved in the segregation, storage and handling of the waste.
2. A definition of the responsibilities of hospital attendants and ancillary staff in collecting and handling wastes, for each ward and department; where special practices are required (e.g. for radioactive waste or hazardous chemical waste), the stage at which attendants or ancillary staff become involved in waste handling shall be clearly defined.

Procedures and practices

1. Simple diagram (flowchart) showing procedure for waste segregation.
2. The procedures for segregation, storage and handling of wastes requiring special arrangements, such as autoclaving.
3. Outline of monitoring procedures for waste categories and their destination.
4. Contingency plans, containing instructions on storage or evacuation of health-care waste in case of breakdown of the treatment unit or during closure for planned maintenance.
5. Emergency procedures.

Box 5.2 continued

Training

Description of the training courses and programmes to be set up and the personnel who should participate in each. For further information, refer to *Basic steps in the preparation of health-care waste management plans for health care establishments* (WHO CEHA, 2002), which is available for purchase through the website (<http://www.emro.who.int/ceha>).

5.3.5 Implementation of the waste-management plan

The head of hospital is responsible for implementing the waste-management plan. Implementation involves the following steps:

1. Interim measures, to be introduced as a precursor to complete implementation of the new waste-management system, should be developed by the waste-management officer, in collaboration with the waste-management committee, and be appended to the plan. A bar chart should also be added, showing dates of implementation of each part of the new system.
2. Provision for future expansion – of the hospital or of waste-storage facilities – should be made.
3. The head of hospital appoints personnel to the posts with responsibility for waste management. Notices of these appointments should be widely circulated, and updates should be issued when changes occur.
4. The infection-control officer should organize and supervise training programmes for all staff, in collaboration with the waste-management officer and other members of the waste-management committee. Initial training sessions should be attended by key staff members, including medical staff, who should be urged to be vigilant in monitoring the performance of waste-disposal duties by non-medical staff. The infection-control officer should choose the speakers for training sessions and determine the content and type of training given to each category of personnel.

As soon as the actions in steps 1–4 have been completed and the necessary equipment for waste management is available, the operations described in the waste-management plan can be put into practice.

The waste-management committee should review the waste-management plan annually and initiate changes necessary to upgrade the system. Interim revisions may also be made as and when necessary. These revisions should be documented at the time and added as an appendix to the waste-management plan; they should be incorporated into the full plan when it is reviewed. The waste-management committee should also update policies and practices as new national guidance becomes available. Failures in waste handling, segregation, storage, transport or disposal systems, or waste management incidents that result in injury, should be reported as soon as possible to the infection-control officer and the waste-management officer.

The head of hospital should prepare an annual report to the national government agency responsible for the disposal of health-care wastes, providing data on waste generation and disposal, personnel and equipment requirements, and costs.

An initial approach to planning

The approach and recommendations in a waste-management plan should be implemented incrementally, through gradual improvements. It is important for public authorities and managers of health-care facilities to be fully aware of the infection-control reasons for having proper waste-management procedures.

Introducing waste segregation is the first step in implementing a waste-management plan. Too often, health-care facilities treat hazardous health-care waste in the same manner as general waste. Improving the separation and safe storage of used sharps is a good starting point. Specific methods for disposing of hazardous health-care wastes can then be introduced, followed by measures to encourage waste minimization and the safe reuse of materials, wherever possible.

5.4 Minimum approach to planning

Managing health-care waste safely requires clear objectives and planning at national and local levels. Health-care waste management should involve national partners and stakeholders, and be based on priorities identified by all partners and stakeholders.

5.5 Desirable improvements to the minimum approach

Improvements to the initial, minimum approach to planning health-care waste management should be as follows:

- Health-care waste generation is understood in more detail for each department in a health-care facility.
- Health-care waste management is defined as a concern and a priority at national and local levels.
- Resources can be mobilized within a country to begin and sustain improvements to health-care waste management.
- Waste-management committees have been formally set up in each health-care facility as part of the serious management of infection control.

Key points to remember

Be clear on the purpose of a national management plan – it is to improve infection control and increase the health-care waste-management options nationally.

There are distinct steps to develop a national programme for health-care waste management. They are:

- secure a firm commitment by government, give responsibility to a lead organization, and conduct a national survey on practices;
- develop a policy on acceptable waste-management methods, develop regulations, and institute a training programme;
- review the national programme after implementation and ensure allocation of funds in national and local government budgets.

The following key members of staff should comprise the health-care waste-management team in larger health-care facilities:

- head of hospital (as chairperson), heads of hospital departments, infection-control officer, chief pharmacist, radiation officer, matron (or senior nursing officer), hospital manager, hospital engineer, financial controller, waste-management officer.

A local health-care waste-management plan should have the following standard set of contents:

- location and organization of segregation, collection, transport and storage facilities; design/performance specifications; required material and human resources; responsibilities; procedures and practices; and monitoring and training.

In addition to hospitals and clinics, other sources produce health-care waste:

- private medical or dental practitioners, research activities, nursing homes, home treatment, ambulance services, veterinary centres, prison clinics, funeral parlours and mortuaries.

5.6 References and further reading

References

Christen J (1996). *Dar es Salaam Urban Health Project – health care waste management in district health facilities: situational analysis and system development*. St Gallen, Swiss Centre for Development Cooperation in Technology and Management.

WHO (World Health Organization) (1997). *Action plan for the development of a national programme for sound management of hospital wastes*. An outcome of the Regional Consultation on Sound Management of Hospital Waste, Chiang Mai, Thailand, 28–29 November 1996. New Delhi, World Health Organization Regional Office for South East Asia.

WHO (2000). *Injection safety: technical tools: health care waste management assessment tool*. Geneva, WHO (http://www.who.int/injection_safety/toolbox/techttools/en/index.html).

WHO (2004). *Water sanitation health: health care waste management rapid assessment tool*. Geneva, World Health Organization (http://www.who.int/water_sanitation_health/medicalwaste/hcwmtool/en/index.html).

WHO (2007a). *Water sanitation health. WHO core principles for achieving safe and sustainable management of health-care waste*. Geneva, World Health Organization (available at http://www.who.int/water_sanitation_health/medicalwaste/hcwprinciples/en/index.html).

WHO (2007b). *Health care waste management – expanded costing analysis tools*. Geneva, World Health Organization (<http://www.healthcarewaste.org/resources/documents/?id=218>).

WHO, Basel Convention, UNEP (United Nations Environment Programme) (2005). *Preparation of national health care waste management plans in sub-Saharan countries: guidance manual*. Geneva, World Health Organization and United Nations Environment Programme.

WHO CEHA (Centre for Environmental Health Activities) (2002). *Basic steps in the preparation of health care waste management plans for health care establishments*. Geneva, World Health Organization (<http://www.emro.who.int/ceha>).

WHO WPR (WHO Western Pacific Region) (1994). *Regional guidelines for health-care waste management in developing countries*. Kuala Lumpur, World Health Organization Western Pacific Region Environmental Health Centre.

Further reading

HSE (Health and Safety Executive) (2005). *Controlling the risks of infection at work from human remains – a guide for those involved in funeral services (including embalmers) and those involved in exhumation*. Suffolk, Health and Safety Executive (<http://www.hse.gov.uk/pubns/web01.pdf>).

WHO (World Health Organization) (1995). *Survey of hospital wastes management in South-East Asia Region*. Document no. SEA/EH/493. New Delhi, World Health Organization Regional Office for South-East Asia.

WHO (2008). *Framework for conducting a self-assessment of national progress in injection waste management*. Geneva, World Health Organization (available only by referral to WHO, Water, Sanitation and Health Division, Geneva).

WHO (2010). *Health care waste management rapid assessment tool (RAT)*, 2nd ed. Geneva, World Health Organization.

WHO CEHA (Centre for Environmental Health Activities) (2005). *Better health care waste management: an integral component of health investment*. Geneva, World Health Organization (<http://www.emro.who.int/ceha>).

WHO, CEPIS (Center for Environmental Engineering Sciences) (1994). *Guia para el manejo interno de residuos solidos hospitalarios [Guide to the internal management of solid hospital waste]*. Lima, World Health Organization and Pan American Sanitary Engineering and Environmental Sciences Center.

6

Health-care waste minimization, reuse and recycling

Key questions to answer

What is the waste-management hierarchy?

What are the waste-minimisation options?

What is waste-management best practice?

6.1 The waste-management hierarchy

Protecting public health through the management of wastes can be achieved by a variety of methods. These can be summarized in an order of preference called the ‘waste hierarchy’, with the most desirable method at the top to the least desirable at the base (Figure 6.1). ‘Desirability’ is defined in terms of the overall benefit of each method from their particular impacts on the environment, protection of public health, financial affordability and social acceptability.

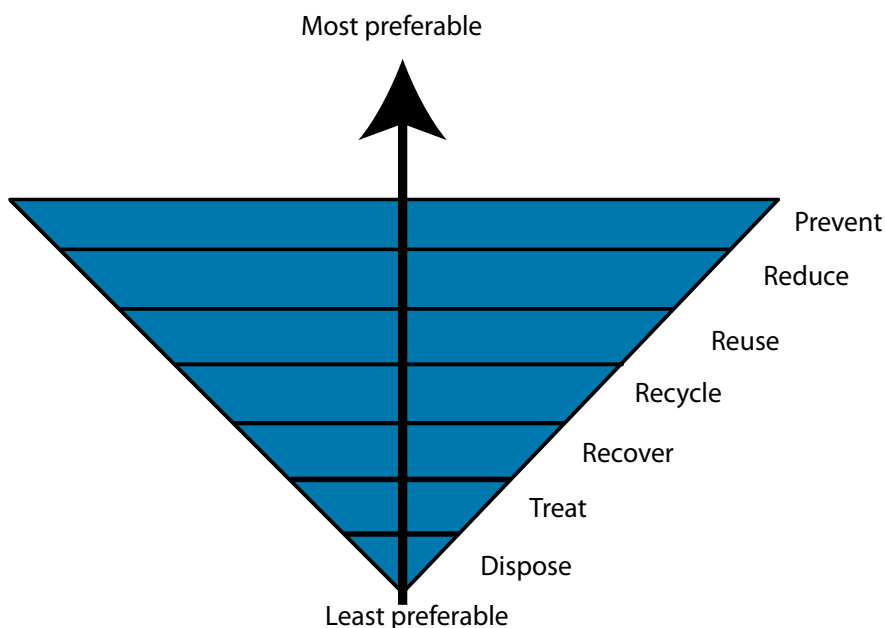

Figure 6.1 The waste-management hierarchy

The waste-management hierarchy is largely based on the concept of the “3Rs”, namely *reduce*, *reuse* and *recycle*, and broadly relates to the sustainable use of resources. Best practice waste management will aim to avoid or recover as much of the waste as possible in or around a health-care facility, rather than disposing of it by burning or burial. This is sometimes described as tackling waste “at source” rather than adopting “end-of-pipe” solutions.

The most preferable approach, if locally achievable, is to avoid producing waste as far as possible and thus minimize the quantity entering the waste stream. Where practicable, recovering waste items for secondary use is the next most preferable method. Waste that cannot be recovered must then be dealt with by the least preferable options, such as treatment or land disposal, to reduce its health and environmental impacts.

6.2 Waste minimization

The preferred management solution is quite simply not to produce the waste, by avoiding wasteful ways of working. To achieve lasting waste reduction (or minimization), the focus should be on working with medical staff to change clinical practices to ones that use less materials. Although waste minimization is most commonly applied at the point of its generation, health-care managers can also take measures to reduce the production of waste through adapting their purchasing and stock control strategies. Examples of policies and practices found to minimize quantities of waste are summarized in Box 6.1.

Box 6.1 Examples of practices that encourage waste minimization

Source reduction

- Purchasing reductions: selecting supplies that are less wasteful where smaller quantities can be used, or that produce a less hazardous waste product.
- Use of physical rather than chemical cleaning methods (e.g. steam disinfection instead of chemical disinfection).
- Prevention of wastage of products (e.g. in nursing and cleaning activities).

Management and control measures at hospital level

- Centralized purchasing of hazardous chemicals.
- Monitoring of chemical use within the health centre from delivery to disposal as hazardous wastes.

Stock management of chemical and pharmaceutical products

- More frequent ordering of relatively small quantities rather than large amounts at one time, to reduce the quantities used (applicable in particular to unstable products).
- Use of the oldest batch of a product first.
- Use of all the contents of each container.
- Checking of the expiry date of all products at the time of delivery, and refusal to accept short-dated items from a supplier.

Waste minimization usually benefits the waste producer: costs for both the purchase of goods and for waste treatment and disposal are reduced, and the liabilities associated with the disposal of hazardous waste are also lower.

All employees have a role to play in this process and should be trained in waste minimization. This is particularly important for the staff of departments that generate large quantities of hazardous health-care waste.

Suppliers of chemicals and pharmaceuticals can also become responsible partners in waste-minimization programmes. The health centre can encourage this by ordering only from suppliers who provide rapid delivery of small orders, who accept the return of unopened stock, and who offer offsite waste-management facilities for hazardous wastes.

6.3 Environmentally preferable purchasing

Environmentally preferable purchasing (EPP) refers to the purchase of the least damaging products and services, in terms of environmental impact. At its simplest, EPP may lead to the purchase of recycled paper, through to more sophisticated measures such as the selection of medical equipment based on an assessment of the environmental impact of the equipment from manufacture to final disposal – known as “life-cycle thinking”. The Department of Sanitation New York City has produced a useful EPP guide;⁵ another example of EPP is from a study undertaken in South Africa for public health clinics, which included consideration of green purchasing.⁶ A health-care centre

5 See <http://nyc.gov/html/nycwasteless/downloads/pdf/eppmanual.pdf>

6 See <http://www.hst.org.za/uploads/files/wastemx.pdf>

with an EPP policy in place may have a requirement that purchases can only be made from suppliers with an environmental management system (see section 6.7).

The application of EPP can help health-care centres to reduce their overall impact on the environment, provide healthier conditions for patients and staff by switching to less hazardous materials (e.g. solvents, cleaning fluids), and lower the costs related subsequently to waste disposal. A widely cited example is the purchase of a mercury versus a mercury-free thermometer. When mercury thermometers break, there are costs associated with cleaning up a hazardous material and then preventing mercury from entering the environment at the final disposal stage (CDHS, 2000; Karliner, 2010; Practice Greenhealth, 2012).

Managing stores carefully will prevent the accumulation of large quantities of outdated chemicals or pharmaceuticals and limit the waste to the packaging (boxes, bottles) plus residues of the products remaining in the containers. These small amounts of chemical or pharmaceutical waste can be disposed of easily and relatively cheaply, whereas disposing of larger amounts requires costly and specialized treatment, which underlines the importance of waste minimization.

Life-cycle management considers benefits, costs and risks over the full life cycle of a product or service – including waste management. Life-cycle management applies approaches to product design and development that minimize environmental impacts of products throughout all life stages of a product, starting with the extraction of resources for raw material inputs, and continuing through processing and manufacturing of all feed stocks and final products, distribution, use and, ultimately, disposal. Life-cycle analysis is a tool used for life-cycle management, to quantify the life-cycle impacts of a product (Kaiser, Eagan & Shaner, 2001).⁷

6.4 Green procurement

Reducing the toxicity of waste is also beneficial, by reducing the problems associated with its treatment or disposal (Kaiser, Eagan & Shaner, 2001). For example, the purchasing manager at a health-care facility could investigate the possibility of purchasing plastics that may be easily recycled, or order goods supplied without excessive packaging.

Globally, the most easily recyclable plastics are polyethylene, polypropylene and polyethylene terephthalate (PET). Conversely, polyvinyl chloride (PVC) is the most difficult, partly because its products come in a variety of forms containing different additives. Packaging of mixed materials, such as paper or card covered in plastic or aluminum foil, is rarely recyclable.

PVC is also of concern because of the toxicity of some of its additives and should be avoided wherever possible. Similarly, polycarbonate is made from bisphenol A, which is an endocrine disruptor. Latex or nitrile gloves are the most common replacements for PVC gloves. Latex or silicone tubing can replace PVC tubing, polyethylene IV bags can replace PVC bags, and ethylene vinyl acetate bags can replace PVC bags for saline and blood. Ethylene oxide is used to sterilize medical devices, but it is carcinogenic and so should be avoided where alternatives exist.

6.4.1 Recycling symbols for plastics

An international classification system to identify different types of plastic is available. Common types in health-care settings are:

- low-density polyethylene – LDPE, 4
- high-density polyethylene – HDPE, 2
- polypropylene – PP, 5
- polyethylene terephthalate – PET or PETE, 1
- polycarbonate – PC, which has no designated number but may be labeled 7 (a miscellaneous category for low-volume plastics).

⁷ Information on the use of life-cycle analysis for health-care waste packaging is presented at Life Cycle Thinking and Assessment for Waste Management (<http://lct.jrc.ec.europa.eu/pdf-directory/Making-Sust-Consumption.pdf>).

Where items are not labelled, procurement staff should contact the manufacturer for further information or change to a product that is clearly labelled as being made from a material known to be recyclable.

6.5 Safe reuse

The reuse of materials in a health-care facility has provoked much debate, with particular concern over the reuse of single-use (medical) devices. In general, the use of non-disposable items for medical procedures should be encouraged where their reuse after cleaning can be demonstrated to minimize infection transmission to acceptably low probabilities. When considering reuse, it is important to make a distinction between different types of products:

- non-medical supplies, disposable items (which should be avoided)
- medical devices that pose no cross-infection risk (e.g. blood-pressure meters)
- medical devices specifically designed for reuse (e.g. surgical instruments).

Single-use devices must not be reused because they cannot be cleaned thoroughly and pose an unacceptable risk of cross-infection. Where there is an option, purchasing a reusable device of similar quality for a medical or non-medical use is preferable to purchasing a single-use device (Box 6.2).

Box 6.2 Reuse of medical devices in Canada

Approximately 41% of Canadian hospitals reuse certain types of non-disposable medical devices, such as endoscopes. Only devices labelled “reusable” can be reused. The reuse of some devices has become common practice, primarily for economic reasons. Subsequently, the Canadian Society of Gastroenterology Nurses and Associates has produced a set of guidelines for its membership to ensure the safe reuse of non-disposable medical devices and also to address legal and ethical issues.

Source: <http://www.csgna.com/en/guidelines/reusable.html>

Syringes and hypodermic needles should not be reused because of the significant chance of spreading disease. Proper steps should be taken to make sure that they are disposed of safely. Where syringes are in short supply, nurses may replace the needle, but the chance of infection remains. A syringe that has been rinsed but not sterilized can still have a 1.8% chance of passing on human immunodeficiency virus if used for intravenous injection and 0.8% for intramuscular injection (Reid & Juma, 2009). Research is limited and the risk is probably underestimated. Anecdotal reports of syringes being repackaged are common, and a survey in Dhaka, Bangladesh (Hassan et al., 2008), confirms that some hospital cleaners salvaged sharps and other materials for reuse. An outbreak of hepatitis in Gujarat, India, in 2009, involving at least 240 cases and 60 deaths, was traced back to the illegal trade in medical waste, as well as direct reuse of single-use items (Solberg, 2009).

Reuse may involve a combination or all of the following steps: cleaning, decontamination, reconditioning, disinfection and sterilization. Common sterilization methods are listed in Box 6.3.

Plastic syringes and catheters should not be reused. However, they may be recycled after sterilization.

There are also certain devices (e.g. patient self-administered intermittent urinary catheters, face masks for oxygen administration) that are intended for limited reuse by the individual and only require washing with mild detergents.

Long-term radionuclides conditioned as pins, needles or seeds and used for radiotherapy may be reused after sterilization.

Special measures must be applied in the case of potential or proven contamination with the causative agents of transmissible spongiform encephalopathies (also known as prion diseases). These measures, which are capable of reducing or eliminating infectivity, are described in detail in the World Health Organization (WHO) *Report of a consultation on public health issues related to animal and human encephalopathies* (WHO, 1992).

Box 6.3 Examples of sterilization methods for reusable items

Thermal sterilization

Dry sterilization:

- Exposure to 160 °C for 120 minutes or 170 °C for 60 minutes in a “Poupinel” oven.

Wet sterilization:

- Exposure to saturated steam at 121 °C for 30 minutes in an autoclave.

Chemical sterilization

Hydrogen peroxide:

- A 7.5% solution can produce high-level disinfection in 30 minutes at 20 °C. Alternatively, equipment exists that can generate a hydrogen peroxide plasma from a 58% hydrogen peroxide solution. The equipment has a 45-minute process time. Hydrogen peroxide can also be used in combination with peracetic acid.

Peracetic acid:

- Can produce sterilization in 12 minutes at 50–55 °C, with instruments ready to use in 30 minutes. Peracetic acid can also be used in combination with hydrogen peroxide.

OPA (ortho-phthaldehyde):

- High-level disinfection in 12 minutes at 20 °C.

Hypochlorous acid/hypochlorite:

- 400–450 ppm active free chlorine, contact conditions established by simulated use testing with endoscopes.

NOTE: ethylene oxide and glutaraldehyde are widely used but are being replaced in an increasing number of health-care facilities because of their health effects. Ethylene oxide is a human carcinogen, and glutaraldehyde can cause asthma and skin irritation.

Source: USEPA (2002); United States Food and Drug Administration list of approved sterilants (March 2009)

The effectiveness of thermal sterilization may be checked – for example, by the *Bacillus stearothermophilus* test and for chemical sterilization by the *Bacillus subtilis* test (see Chapter 8).

Certain types of containers may be reused, provided they are carefully washed and disinfected. Containers for pressurized gas should be sent to specialized centres to be refilled. Containers that once held detergent or other liquids may be reused as containers for sharps waste (if purpose-made containers are not affordable), provided they are puncture-proof and clearly marked on all sides for used sharps.

6.6 Recycling and recovery

Recycling is practised by a wide range of institutions, including municipalities, private companies, households, and public institutions such as schools and hospitals. From an environmental perspective, recycling is less desirable than reusing a waste item, because it frequently requires substantial energy input and transport to offsite recycling centres.

The recovery of waste is defined in one of two main ways. Most simply, “recovery” commonly refers to energy recovery whereby waste is converted to fuel for generating electricity or for direct heating. In temperate climates, the heat generated by onsite incinerators may be an attractive and cost-effective option for heating hospitals, public buildings and residential districts. Alternatively, “waste recovery” is a term used to encompass recycling of waste items to be converted into new products, and composting of organic waste matter to produce compost or soil conditioner for use in agriculture or similar purposes.

Recycling is increasingly popular in some health-care facilities, especially for the large, non-hazardous portion of waste. It can reduce costs considerably, either through reduced disposal costs or through payments made by a recycling company for the recovered materials (Box 6.4).

Box 6.4 Recycling at the Heart of England NHS Foundation Trust

The Heart of England National Health Service (NHS) Foundation Trust facility in the United Kingdom generates the annual waste equivalent of 5500 households. The trust invested in balers and compactors to facilitate waste recycling, particularly paper and cardboard.



Photos: Paul Williams, Heart of England NHS Foundation Trust

Some of the hazardous infectious portion of the waste will contain recyclable materials (e.g. paper, cardboard, packaging, tubing; see Box 6.5). These materials can also be recycled, provided they are disinfected to eliminate possible pathogens, and safe handling guidelines are followed.

Box 6.5 Recycling infectious waste in Nepal



The nongovernmental organization Health Care Foundation – Nepal recycles blood-contaminated plastics after autoclaving. The foundation also recycles paper, plastic and glass, and estimates that 40% of waste-handling costs are covered by recycling.

Autoclave used for treating infectious waste, and disinfected waste ready for recycling.

Photo: Mahesh Nakarmi, Health Care Foundation – Nepal

Composting hospital food waste is also attracting interest, particularly in countries where the use of landfill is becoming more restrictive due to legislation, taxation, service charges or land shortages. There are legitimate concerns about compost attracting rodents and other pests; however, these problems can be minimized with careful management (Box 6.6).

Box 6.6 Hospital food waste composting

The Newham General Hospital in the United Kingdom began onsite composting of food waste in 2007. The new technology, a Rocket® In-Vessel Composter, produces compost from kitchen waste (including cooked foods) in 14 days, and the compost is then allowed to mature for 12 weeks. The composter is a closed system and so prevents odours, flies and other pests. The hospital has reduced the amount of waste sent to landfill, while also creating jobs to manage the composting operation.

Source: <http://peoplepoweredmachines.wordpress.com/tag/hospitals>

In determining the economic viability of recycling and recovery, it is important to take account of the costs of alternative disposal methods, as well as the value of reclaimed materials, and not just the cost of the recycling and recovery process.

6.7 Environmental management systems

An environmental management system (EMS) is a formal approach in countries with strict environmental laws to manage an organization's impact on the environment. Hospitals and health centres of any size should derive a benefit from introducing and implementing an EMS. These benefits include cost reductions through reduced energy consumption, reduced quantities of waste, increased recycling, minimized negative impacts on the environment from waste handling and treatment, and an improved public image.

An EMS framework encompasses the environmental aspects of waste management, including reduction, reuse and recycling. It also has considerable relevance to environmentally preferable purchasing. This is because a health-care facility usually has a choice in the purchase of products or services. It is becoming increasingly common to require suppliers to have an EMS in place as a condition of awarding contracts. An EMS should be an integral part of an organization's approach to good management. It is used to develop and implement its environmental policy and to manage its continuing environmental impacts.

Key elements of an EMS should include the following:

- process or mechanism for screening project plans and proposals for potential environmental risks; for example, using screening tools, checklists and expert review;
- development and use of environmental management plans that clearly define which environmental mitigation measures should be taken, by whom, and at which point in the project's implementation;
- monitoring and reporting activities to verify that relevant environmental management actions are being taken and that they are generating the intended results;
- evaluation of the overall environmental performance of projects and activities to inform organizational learning and future environmental mitigation actions.

Many organizations, including hospitals, introduce an EMS with the aim of obtaining ISO 14001 certification as stipulated by the International Standards Organization (ISO). ISO 14001 provides the specific requirements for an EMS and is part of the ISO 14000 series that relates more generally to environmental management. As an example, a hospital in the United Kingdom introduced an EMS and worked with local authorities and waste contractors to change waste-management methods and introduce recycling schemes. They found that using an environmental procurement policy reduced health-care waste quantities by 4.1% (78 tonnes), energy consumption by 3.6% and water usage by 9.6%.⁸

⁸ See <http://www.corporatecitizen.nhs.uk/casestudies.php/15/cardiff-and-vale-nhs-trust-environmental-management-system>

6.8 Minimum approach to waste minimization

The waste-minimization hierarchy should feature in the waste-management policy of all health-care facilities, with a broad aim to move current practices upwards in the hierarchy from predominantly disposal to an emphasis on recycling or even prevention.

The first practical steps are to pay more attention to the quantity and type of materials purchased regularly, establish a system to gather waste-management ideas from staff, evaluate these ideas, and put the good ideas into practice. Often, there will be obvious opportunities to reduce the amount and toxicity of materials purchased, and hence the amount and toxicity of waste generated. Targets could be both quantitative (e.g. consumption of paper will be reduced by 10%) or qualitative (e.g. hazardous solvents will be substituted by more environmentally friendly products). Educating staff to use medical materials carefully to avoid generating unnecessary waste is a further simple measure that can be undertaken. Reuse is another option to minimize waste, but it is not without complications and requires a realistic assessment of which reuse practices are considered safe and which to avoid because the risk of infection transmission to patients and staff is unacceptable.

It is sensible for health-care managers to periodically review their purchasing practices and available choices, and to remind their staff to avoid excessive waste production wherever possible.

6.9 Desirable improvements to the minimum approach

The initial approach envisages a health-care centre that has attempted some reduction in the waste it produces. Several opportunities allow health-care centres to go beyond this, including by expanding the effort in reducing waste and extending the activities to more items. Encouraging staff to extend waste minimization requires the adoption of more rigorous methods and disciplines. Waste-minimization targets can be established for each area of medical or support activities, and people can be made more personally responsible for waste minimization – possibly by providing incentives for those people and departments who are successful in achieving their targets. A significant step in improving waste minimization is to adopt life-cycle management for items used in large quantities and for frequently used services. Further techniques can involve working with suppliers to make available products from materials that degrade more easily or that can be used again for secondary purposes. Collectively, these improvements can further reduce the physical quantity of waste, and environmental impacts from the remaining health-care waste requiring treatment and disposal.

Key points to remember

The waste-management hierarchy provides clear guidance on which approaches to waste management are most desirable from an environmental, economic and social perspective. If these approaches are practicable, then they should be used.

Minimization is always preferable to generating waste and then handling and managing its recovery, treatment and disposal.

An environmental management system is a structured way to make choices by using a defined set of procedures and processes that, when followed, mitigate environmental impacts from health-care activities.

Recycling and reduction practices should become part of everyday operations throughout a health-care facility.

Staff, patient and public safety can be improved by all staff undertaking waste-minimization practices routinely in their daily work.

6.10 References and further reading

References

CDHS (California Department of Health Services) (2000). *A guide to mercury assessment and elimination in healthcare facilities*. Sacramento, California, Department of Health Services (<http://www.cdph.ca.gov/certlic/medicalwaste/Documents/MedicalWaste/GuidetoMercuryAssesswd2000v1.11.pdf>).

Hassan MM et al. (2008). Pattern of medical waste management: existing scenario in Dhaka City, Bangladesh. *BMC Public Health*, 8:36–45.

Kaiser B, Eagan PD, Shaner H (2001). Solutions to health care waste: life-cycle thinking and “green” purchasing. *Environmental Health Perspectives*, 109(3):205–207.

Karliner J (2010). *Toward the tipping point: WHO-HCWH global initiative to substitute mercury-based medical devices in health care – a two-year progress report*. Geneva, Switzerland and Arlington, Virginia, WHO and Health Care Without Harm (http://www.mercuryfreehealthcare.org/Toward_the_Tipping_Point.pdf).

Practice Greenhealth (2012). Mercury elimination tools & resources. Reston, Virginia, Practice Greenhealth (<http://practicegreenhealth.org/topics/chemicals/mercury/mercury-use-healthcare>).

Reid S, Juma OA (2009). Minimum infective dose of HIV for parenteral dosimetry. *International Journal of STD & AIDS*, 20:828–833.

Solberg KE (2009). Trade in medical waste causes deaths in India. *Lancet*, 373:1067.

USEPA (United States Environmental Protection Agency) (2002). *Reducing ethylene oxide and glutaraldehyde use*. Washington, United States Environmental Protection Agency (<http://www.epa.gov/region9/waste/p2/projects/hospital/glutareth.pdf>).

WHO (World Health Organization) (1992). *Report of a WHO consultation on public health issues related to animal and human encephalopathies*. Geneva, World Health Organization (unpublished document WHO/CDS/VPH/92.104, distributed in limited number, available on request from Department of Communicable Disease Surveillance and Response, World Health Organization, 1211 Geneva 27, Switzerland).

Further reading

Gabela SD (2007). *Health care waste management in public clinics in the Ilembe district: a situational analysis*. Durban, Health Systems Trust (<http://www.hst.org.za/uploads/files/wastemx.pdf>).

Messelbeck J, Whaley M (1999). Greening the health care supply chain: triggers of change, models for success. *Corporate Environmental Strategy*, 6:39–45.

Science Applications International Corporation (2001). *Environmentally preferable purchasing*. New York, New York City Department of Sanitation, Bureau of Waste Prevention, Reuse and Recycling (<http://www.nyc.gov/html/nycwasteless/downloads/pdf/eppmanual.pdf>).

US FDA (United States Food and Drug Administration) (2009). *US FDA list of approved sterilants, March 2009*. Silver Spring, United States Food and Drug Administration (<http://www.fda.gov/MedicalDevices/DeviceRegulationandGuidance/ReprocessingofSingle-UseDevices/ucm133514>).

WHO (2001). *Infection control guidelines for transmissible spongiform encephalopathies*. Report of a WHO consultation, Geneva, Switzerland, 23–26 March 1999 (report WHO/CDS/CSR/APH/2000.3). Geneva, World Health Organization (http://whqlibdoc.who.int/hq/2000/WHO_CDS_CSR_APH_2000.3.pdf).

7

Segregation, storage and transport of health-care waste

Key questions to answer

Segregation and collection from medical areas

Why is segregation important?

How to begin waste segregation?

What are the recommended and minimum segregation systems?

Who should be trained in segregation?

What containers are needed and where should they be placed?

How frequently should wastes be collected?

Who is responsible for making sure that segregation and transportation are done correctly?

Storage and transport inside the health-care facility

What are the present handling and storage methods?

Are there national or local legal regulations to define acceptable storage and transport?

What should happen when containers for segregated waste are full?

Should local storage be used or can frequent collection be arranged?

Who undertakes collection and transportation inside a health-care facility and who is in charge of transport and storage?

Where should central storage for wastes be located?

How are transport and storage activities financed?

What is the current situation of transport and storage inside the health-care facility?

Are health-care facility staff trained in storage and transport activities?

Are there appropriate systems in place for labelling and separate storage and transport of hazardous and non-hazardous waste?

What mitigation measures have been put in place to reduce risks for human health, animals and the environment?

Is there regular monitoring of transport and storage conditions?

Offsite waste external transport

Are there national or local legal regulations on transport of health-care waste outside health-care facilities?

Who is responsible for the external collection and transport of non-hazardous and hazardous wastes?

Are registered and authorized transport companies for transporting hazardous health-care waste available?

Does the health-care facility pay for hazardous and general solid waste collection and transportation?

Can the private sector provide well-managed transport services for hazardous health-care waste at an affordable price?

Are quality issues and penalties considered in the contracts with external companies?

Are there contingency plans available if external waste collection and transport is delayed?

7.1 Guiding principles

Health-care facility managers have a “duty of care” (often required by national regulations) to ensure that waste is kept under control at all times within a health-care facility and disposed of safely either onsite or offsite. Proper segregation, onsite storage and transportation systems are described in this chapter and provide a continuous sequence of safe keeping at each step in the process, from the point of generation of waste to its final treatment or disposal. Each step in the concept of managing the “waste flow” is given below.

The following general principles of waste segregation, storage and transportation relate to the control of waste flow from generation to disposal:

- health-care waste is generated in a medical area and should be segregated into different fractions, based on their potential hazard and disposal route, by the person who produces each waste item;
- separate containers should be available in each medical area for each segregated waste fraction;
- waste containers when filled should be labelled to help managers control waste production;
- closed local storage inside or near to a medical area may be needed if wastes are not collected frequently;
- hazardous and non-hazardous wastes should not be mixed during collection, transport or storage;
- collected waste is often taken to central storage sites before onsite or offsite treatment and disposal;
- staff should understand the risks and safety procedures for the wastes they are handling.

7.2 Segregation systems

The correct segregation of health-care waste is the responsibility of the person who produces each waste item, whatever their position in the organization. The health-care facility management is responsible for making sure there is a suitable segregation, transport and storage system, and that all staff adhere to the correct procedures.

Segregation should be carried out by the producer of the waste as close as possible to its place of generation, which means segregation should take place in a medical area, at a bedside, in an operating theatre or laboratory by nurses, physicians and technicians. If classification of a waste item is uncertain, as a precaution it should be placed into a container used for hazardous health-care waste.

The simplest waste-segregation system is to separate all hazardous waste from the larger quantity of non-hazardous general waste. However, to provide a minimum level of safety to staff and patients, the hazardous waste portion is commonly separated into two parts: used sharps and potentially infectious items. In the latter, the largest components are typically tubing, bandages, disposable medical items, swabs and tissues. Consequently, the segregation of general, non-hazardous waste, potentially infectious waste and used sharps into separate containers is often referred to as the “three-bin system”. Further types of containers can be used for other categories of wastes, such as chemical and pharmaceutical wastes, or to separate out pathological waste, where it is to be handled and disposed of in different ways from the other portions of the waste flow.

7.2.1 Waste containers, colour codes and labels

Ideally, the same system of segregation should be in force throughout a country, and many countries have national legislation that prescribes the waste segregation categories to be used and a system of colour coding for waste containers. Where there is no national legislation, a World Health Organization (WHO) scheme is available (Table 7.1). Colour coding makes it easier for medical staff and hospital workers to put waste items into the correct container, and to maintain segregation of the wastes during transport, storage, treatment and disposal. Colour coding also provides a visual indication of the potential risk posed by the waste in that container.

Table 7.1 WHO-recommended segregation scheme

Type of waste	Colour of container and markings ^a	Type of container
Highly infectious waste	Yellow, marked "HIGHLY INFECTIOUS", with biohazard symbol	Strong, leak-proof plastic bag, or container capable of being autoclaved
Other infectious waste, pathological and anatomical waste	Yellow with biohazard symbol	Leak-proof plastic bag or container
Sharps	Yellow, marked "SHARPS", with biohazard symbol	Puncture-proof container
Chemical and pharmaceutical waste	Brown, labelled with appropriate hazard symbol	Plastic bag or rigid container
Radioactive waste ^b	Labelled with radiation symbol	Lead box
General health-care waste	Black	Plastic bag

^a see Figure 7.1 (which lists the biohazard and radiation symbols)

^b Not produced in all hospitals

Labelling of waste containers is used to identify the source, record the type and quantities of waste produced in each area, and allow problems with waste segregation to be traced back to a medical area. A simple approach is to attach a label to each filled container with the details of the medical area, date and time of closure of the container, and the name of the person filling out the label. Using an international hazard symbol on each waste container is also recommended. Several symbols are relevant to the different kinds of hazardous waste produced in a health-care facility, and these are reproduced in Figure 7.1.



Biohazard symbol



Old radiation symbol



New radiation symbol

Note: The new radiation symbol was adopted by the United Nations in 2007, but the older symbol is still widely recognized and expected to remain in common use for many years.

Figure 7.1 Biohazard, radiation and chemical hazard symbols

Figure 7.2 compares symbols from Annex II of the European Commission's *Directive on dangerous substances 67/548/EEC* (in the left-hand column)⁹ with those from the United Nations Economic Commission for Europe's (UNECE's) *Globally harmonized system of classification and labelling of chemicals* (in the right-hand column).¹⁰

⁹ See http://ec.europa.eu/environment/archives/dansub/consolidated_en.htm

¹⁰ See <http://live.unece.org/trans/danger/publi/ghs/pictograms.html>



Corrosive (C)

These substances attack and destroy living tissues, including the eyes and skin.



Highly flammable (F)

These substances easily catch fire (flash point: 21–55 °C). Never store flammable substances together with explosive ones.



Toxic (T)

These substances can cause death. They may have their effects when swallowed or breathed in, or when absorbed through the skin.



Harmful (Xn)

These substances are similar to toxic substances but are less dangerous.



Explosive (E)

An explosive is a compound or mixture susceptible to a rapid chemical reaction, decomposition or combustion, with the rapid generation of heat and gases with a combined volume much larger than the original substance.



Irritant (I)

These substances can cause reddening or blistering of skin.



Figure 7.2 Comparison of common hazardous waste symbols



Extremely flammable (F+)

Liquid substances and preparations that have an extremely low flash point (<21 °C) and therefore catch fire very easily.



Very toxic (T+)

Substances and preparations that, in very low quantities, cause death or acute or chronic damage to health when inhaled, swallowed or absorbed via the skin.



Oxidising (O)

These substances provide oxygen, which allows other materials to burn more fiercely.



Dangerous for environment (N)

Substances that, were they to enter into the environment, would present or might present an immediate or delayed danger for one or more components of the environment.



Specific organ toxicity

No direct equivalent; use harmful or irritant symbol as appropriate

These substances may cause:

- damage to organ or organs after single or repeated exposure
- respiratory sensitization
- allergy or asthma or breathing difficulties if inhaled.



7.2.2 Beyond basic segregation

Non-hazardous waste

Within each major category (e.g. non-hazardous, potentially infectious, used sharps), further segregation may be advantageous. For example, general non-hazardous waste can be broken down into recyclables, biodegradable waste and non-recyclable portions. If these are mixed at the point of generation, it may prevent recyclables from being recovered.

Food wastes can be collected from medical areas and returned directly to the kitchens. Kitchen wastes can be composted or, where regulations allow, sterilized and used for animal feed. Non-hazardous biodegradable wastes (e.g. flowers) may be disposed of with kitchen waste.

Hazardous waste

Highly infectious waste, such as diagnostic laboratory samples and waste from infectious patients in isolation, should be collected separately and autoclaved at the point of generation. Once disinfected, the waste would leave a medical area in the infectious health-care waste container.

Anatomical waste, particularly recognizable body parts or fetal material, should be handled according to prevailing religious and cultural preferences (most commonly, authorized burial or cremation). In low-resource areas, placentas and other non-recognizable anatomical waste can be disposed of in a pit where it can biodegrade naturally.

Sharps waste (needle and syringe combination) should be placed directly into a sharps container. In some places, it is permitted for syringes to have their needles removed or destroyed before placing the syringe in an infectious waste bin. Any removed needles are placed in a puncture-proof container and dealt with accordingly. This approach is not universally accepted as best practice.

Policies regarding the use of needle cutters (also known as hub cutters) or needle pullers, and destroyers vary from country to country. A needle puller is a type of pliers that removes the needle from the syringe – a process called defanging. (Luer-lock needles do not require a puller to defang them – they can simply be unscrewed from the syringe.) In some countries, needle cutters or pullers, or destroyers are mandatory for vaccination programmes. A WHO study investigated the advantages and risks of needle cutters (Ahmed, 2010); the study group used needle cutters or destroyers, and the comparison group used usual practice. There was no statistically significant difference in the number of needle-stick injuries among the injection providers and waste handlers, or blood exposures among the injection providers; however, injuries and exposures were slightly lower in the group using the needle cutters/needle pullers. The use of hub cutters/needle pullers did not increase the amount of time required to give the vaccinations. The overall amount of waste produced during the study was slightly less in the group that used the hub cutters/needle pullers, but less than 0.2% of it was sharps waste. Table 7.2 summarises the advantages and disadvantages of needle cutters/destroyers.

Various chemical and pharmaceutical wastes should be segregated and collected separately: subcategories include mercury, batteries, cadmium-containing wastes, photochemicals, stains and laboratory reagents, cytotoxic drugs and other pharmaceuticals. All should be clearly labelled with the type of waste and the name of the major chemicals, with any necessary hazard labels attached to corrosive, flammable, explosive or toxic chemicals. Liquid chemical wastes should never be mixed or disposed of down the drain, but should be stored in strong leak-proof containers. It may be possible to recover silver from photochemicals at a profit, and return of chemicals to suppliers should be practised where possible. Silver is increasingly being used in medical products, but is rarely segregated due to a lack of dedicated disposal or metals recovery facilities. Low-energy light bulbs (compact fluorescents) contain small amounts of mercury. Both these and batteries should be segregated and treated by recycling processes, where suitable facilities exist.

Table 7.2 Advantages and disadvantages of needle cutters/destroyers

Advantages	Disadvantages
Prevents reuse of syringe either inadvertently or illegally	Cost: one will be needed wherever injections are given and will require maintenance. Sharps containers may still be needed for lancets and other sharps waste
Reduces volume of sharps wastes significantly	Some models collect the sharps in containers that need to be capped after filling; potential for spilling of needles and/or needle-stick injuries during container exchange
Potential for recycling syringe barrels after disinfection	Potential splash of blood during operation
Removes inclination of staff to recap used needles	Busy staff may leave syringes to be cut later, increasing chances of needle-stick injuries and infection from discarded syringes
Reduces risk of injury from improperly disposed syringes	Some needle destroyers are electrically operated and so not appropriate where power cuts are common

Mercury use is being reduced in health care and other applications around the world because of its toxicity and pollution potential. Since it is volatile, spilled mercury can be inhaled by staff and patients if it is not cleaned up properly, but a simple spill kit can be cheap and effective. Where mercury thermometers and sphygmomanometers are still in use, medical staff should be supplied with a spill kit and trained in how to use it. Any spill larger than a thermometer should be dealt with in consultation with the local health and safety authority. Brushes and vacuum cleaners should never be used for spilled mercury. Mercury can be cleaned up easily from wood, linoleum, tile and similar smooth surfaces. It cannot be completely removed from carpets, curtains, upholstery or other absorbent materials. The affected portion should be isolated and disposed of in accordance with official guidelines. For more information on spill clean-up, see section 11.3.2.

Unused pharmaceuticals should go back to the pharmacy for return to the manufacturers or dispatched to specialist waste-treatment contractors. Pharmaceuticals should be kept in their original packaging to aid identification and prevent reaction between incompatible chemicals. Spilt and contaminated chemicals and pharmaceuticals should not be returned to the pharmacy but should go directly from the point of production to a waste store. Typically, they are stored and transported within a health-care facility in brown cardboard boxes and must be kept dry.

Where specialist disposal services exist, they should collect and handle radioactive wastes. Otherwise, waste may be stored in secure, radiation-proof repositories (leak-proof, lead-lined and clearly labelled with the name of the radionuclide and date of deposition) where it should be left to decay naturally.

7.2.3 Waste containers: specifications and siting

Waste containers can come in many shapes and sizes and be made from different materials. Many modern waste containers are designed for automated systems that empty their contents into the waste-disposal system and wash and disinfect them mechanically. At the other end of the scale, waste containers may also be made out of reused plastic and metal containers. In all cases, they should be sturdy and leak-proof, and (except for sharps containers) lined with a sturdy plastic bag. The recommended thickness of bags for infectious waste is 70 µm (ISO 7765 2004). Plastics used for either containers or bags should be chlorine-free. Not all plastic bags can withstand temperatures of 121 °C, and some can melt during an autoclave process.

Containers should have well-fitting lids, either removable by hand or preferably operated by a foot pedal. Both the container and the bag should be of the correct colour for the waste they are intended to receive and labelled clearly. Mixing colours – such as having yellow bags in black bins – should be avoided, because it will increase the potential for confusion and poor segregation.

Since sharps can cause injuries that leave people vulnerable to infection, both contaminated and uncontaminated sharps should be collected in a puncture-proof and impermeable container that is difficult to break open after closure. Performance specifications for these containers are given in WHO (2007).¹¹

11 See http://www.who.int/immunization_standards/vaccine_quality/who_pqs_e10_sb01.pdf.

Sharps containers may be disposable or designed for disinfection and reuse. Disposables are boxes made of plasticized cardboard or plastic (Figure 7.3); reusable designs are plastic or metal. Low-cost options include the reuse of plastic bottles or metal cans. If this is to be done, the original labels should be removed or obscured, and the containers should be clearly relabelled as “Sharps containers”.

The appropriate waste receptacle (bags, bins, sharps boxes) should be available to staff in each medical and other waste-producing area in a health-care facility. This permits staff to segregate and dispose of waste at the point of generation, and reduces the need for staff to carry waste through a medical area. Posters showing the type of waste that should be disposed of in each container should be posted on walls to guide staff and reinforce good habits.

Segregation success can be improved by making sure that the containers are large enough for the quantity of waste generated at that location during the period between collections. Up-to-date waste audit data can be used to assess the volume and type of waste containers necessary, since waste managers also need to spend time with staff in medical areas identifying the type of work that is undertaken. No two areas will be the same.



Proper disposal of used syringes into a designated sharps container



A proper cardboard sharps container



Sharps box in a Peruvian hospital

Photo sources: (left to right) Susan Wilburn, Maxwell Tucker, Susan Wilburn

Figure 7.3 Cardboard safety boxes

Medical staff should be encouraged to think of waste disposal as part of a patient's treatment, so all aspects of the care process are completed at the bedside or treatment room. If intervention at the bedside is required, a waste container should be taken to the bed. Sharps bins are also sometimes taken to a patient for drug administration or blood sampling. A mobile trolley with infectious waste and sharps containers may therefore be more versatile and should be given serious consideration. The alternative is establishing a limited number of locations in a medical area where general waste (black bags) and infectious health-care waste (yellow bags and sharps containers) are placed. The locations should be away from patients; typical sites are the sluice (utility) room, treatment room and nurses' station.

Where containers for segregating hazardous and non-hazardous health-care wastes are in use, they should be located close together, wherever possible. Containers for infectious waste should not be placed in public areas because patients and visitors may use the containers and come into contact with potentially infectious waste items. Static bins should be located as close as possible to sinks and washing facilities, because this is where most staff will deposit gloves and aprons after treating patients. If the general waste container is closest to the sink or under a towel dispenser, it will encourage staff to place towels into the non-infectious receptacle. Containers should be of similar size to overcome the observed tendency for staff to put waste in the largest receptacle.

Unless patients are known or suspected to have readily transmitted infections, the assumption should be that general waste generated in a medical area is of low risk. However, if there is a known communicable infection (e.g. methicillin-resistant *Staphylococcus aureus*, tuberculosis or leprosy), all waste used in and around the patient should be classed as an infection risk and placed in the yellow, potentially infectious waste container. This “blanket” approach to all waste being assumed to be infectious can be avoided where there is a high level of training and

communication between the clinical and support staff. Waste from each patient should be treated according to their known infection status.

7.2.4 Setting and maintaining segregation standards

Segregation methods should be clearly set out in the waste-management policy of a health-care facility. It is important that the waste-management policy is supported and enforced by senior staff and managers. Managers and medical supervisors should know the relevant legislation and understand how to implement waste audits, foresee possible problems and take pre-emptive remedial action. Medical staff and waste handlers should understand the reasons for, and operation of, segregation practices, waste auditing, spill management, and accident and injury reporting. Training should be repeated periodically to ensure that all staff are reminded of their responsibilities.

The waste-management committee is responsible for seeing that segregation rules are enforced and waste audits carried out to quantify the amount of waste being produced. Also, segregation posters for medical and waste workers help to raise knowledge about segregation practices and improve the quality of separated waste components (Figure 7.4).



Sample poster for medical areas

Sample poster for public area

Source: ETLog Health GmbH, Germany

Figure 7.4 Example of a waste-segregation poster

Waste that has been poorly segregated should never be re-sorted, but instead should be treated as the most hazardous type of waste in the container. Corrective action taken should concentrate on ensuring that waste is segregated properly in the future.

As well as confirming that waste is being segregated properly, waste audit data can be used to indicate the type, size and number of containers needed in each area. It should be used to estimate disposal capacity requirements and the amount of recyclables generated. Both are essential pieces of data for good waste management and cost control. It can also be used to track the entire waste stream through to final disposal. In some countries, this is a legal requirement. Hospital managers have a duty to prove that all wastes have been disposed of in accordance with the law, and health-care facilities have to obtain proof of treatment from authorized waste-disposal contractors.

Reuse of medical products is common in some countries. Although it is not recommended practice, disposable gloves are often reused in resource-limited facilities, where they may be autoclaved and repacked for non-clinical use. Alternatively, they may be pilfered from the waste stream for illicit reuse. Similarly, used syringes and other medical devices may be washed and repackaged for resale. To prevent this, it may be necessary to ensure that staff mutilate gloves and other used equipment before placing them in the appropriate waste container.

7.3 Collection within the health-care facility

Collection times should be fixed and appropriate to the quantity of waste produced in each area of the health-care facility. General waste should not be collected at the same time or in the same trolley as infectious or other hazardous wastes.

Waste bags and sharps containers should be filled to no more than three quarters full. Once this level is reached, they should be sealed ready for collection. Plastic bags should never be stapled but may be tied or sealed with a plastic tag or tie. Replacement bags or containers should be available at each waste-collection location so that full ones can immediately be replaced.

Waste bags and containers should be labelled with the date, type of waste and point of generation to allow them to be tracked through to disposal. Where possible, weight should also be routinely recorded. Anomalies between departments with similar medical services or over time at one location can show up differences in recycling opportunities, or problems such as poor segregation and diversion of waste for unauthorized reuse.

Collection should be daily for most wastes, with collection timed to match the pattern of waste generation during the day. For example, in a medical area where the morning routine begins with the changing of dressings, infectious waste could be collected mid-morning to prevent soiled bandages remaining in the medical area for longer than necessary. Visitors arriving later in the day will bring with them an increase in general waste, such as newspapers and food wrappings; therefore, the optimum time for general and recyclable waste collection would be after visitors have departed.

In comparison with this general type of medical area, a theatre would generate a high proportion of potentially infectious waste and could have several collections during the day to fit in with the schedule of operations. A child and maternal health clinic might generate primarily sharps waste from injections, which would be collected at the end of each working day.

7.4 Interim storage in medical departments

Where possible, hazardous waste generated in medical areas should be stored in utility rooms, which are designated for cleaning equipment, dirty linen and waste. From here, the waste can be kept away from patients before removal, then collected conveniently and transported to a central storage facility. This is known as interim or short-term storage (Figure 7.5).

If utility rooms are not available, waste can be stored at another designated location near to a medical area but away from patients and public access. Another possibility for interim storage is a closed container stationed indoors, within or close to a medical area. A storage container used for infectious waste should be clearly labelled and preferably lockable.



Interim waste storage ready for collection



Waste bins in a dirty utility room

Photo source: ETLog Health GmbH, Germany

Figure 7.5 Examples of interim waste storage places

7.5 Onsite transport of waste

7.5.1 General requirements

Onsite transport should take place during less busy times whenever possible. Set routes should be used to prevent exposure to staff and patients and to minimize the passage of loaded carts through patient care and other clean areas. Depending on the design of the health-care facility, the internal transport of waste should use separate floors, stairways or elevators as far as possible. Regular transport routes and collection times should be fixed and reliable. Transport staff should wear adequate personal protective equipment, gloves, strong and closed shoes, overalls and masks.

Hazardous and non-hazardous waste should always be transported separately. In general, there are three different transport systems:

- Waste transportation trolleys for general waste should be painted black, only be used for non-hazardous waste types and labelled clearly “General waste” or “Non-hazardous waste”.
- Infectious waste can be transported together with used sharps waste. Infectious waste should not be transported together with other hazardous waste, to prevent the possible spread of infectious agents. Trolleys should be coloured in the appropriate colour code for infectious waste (yellow) and should be labelled with an “Infectious waste” sign.
- Other hazardous waste, such as chemical and pharmaceutical wastes, should be transported separately in boxes to central storage sites.

The use of waste chutes in health-care facilities is not recommended, because they can increase the risk of transmitting airborne infections.

7.5.2 Transport trolleys

Health-care waste can be bulky and heavy and should be transported using wheeled trolleys or carts that are not used for any other purpose (Figure 7.6). To avoid injuries and infection transmission, trolleys and carts should:

- be easy to load and unload
- have no sharp edges that could damage waste bags or containers during loading and unloading

- be easy to clean and, if enclosed, fitted with a drainage hole and plug
- be labelled and dedicated to a particular waste type
- be easy to push and pull
- not be too high (to avoid restricting the view of staff transporting waste)
- be secured with a lock (for hazardous waste)
- be appropriately sized according to the volumes of waste generated at a health-care facility.

Waste, especially hazardous waste, should never be transported by hand due to the risk of accident or injury from infectious material or incorrectly disposed sharps that may protrude from a container.

Spare trolleys should be available in case of breakdowns and maintenance. The vehicles should be cleaned and disinfected daily. All waste bag seals should be in place and intact at the end of transportation.



Photo source: Susan Wilburn

Figure 7.6 Medical waste transport trolleys outside a hospital in Thailand

7.5.3 Routing

Separate hazardous and non-hazardous routes should be planned and used. In general, a waste route should follow the principle “from clean to dirty”. Collection should start from the most hygienically sensitive medical areas (e.g. intensive care, dialysis, theatres) and follow a fixed route around other medical areas and interim storage locations (Figure 7.7). The frequency of collection should be refined through experience to ensure that there are no overflowing waste containers at any time. Biologically active waste (e.g. infectious waste) must be collected at least daily. A routing plan would be influenced by:

- waste volume and number of waste bags or containers
- waste types
- capacity of the waste storage within medical areas and at interim storage areas
- capacity of the transportation trolleys
- transport distances and journey times between the collection points.



Source: Ute Pieper, ETLog Health GmbH, Germany

Figure 7.7 Example of a health care facility site plan with waste collection points (yellow circles)

7.6 Central storage inside health-care facilities

Central storage areas are places within a health-care facility where different types of waste should be brought for safe retention until it is treated or collected for transport offsite. The general requirements in Box 7.1 are relevant to most types of health-care facilities where sufficient waste is produced and needs to be stored centrally. Some types of waste storage for particular items (e.g. blood, radioactive substances, chemicals) are only likely to be required at large and specialized medical centres.

Box 7.1 Recommendations for storage facilities for health-care waste

The storage area should:

- have an impermeable, hard-standing floor with good drainage (away from watercourses); the floor should be easy to clean and disinfect;
- include the facility to keep general waste separated from infectious and other hazardous waste;
- have a water supply for cleaning purposes;
- have easy access for staff in charge of handling the waste;
- be lockable to prevent access by unauthorized persons;
- have easy access for waste-collection vehicles;
- have protection from the sun;
- be inaccessible to animals, insects and birds;
- have good lighting and at least passive ventilation;
- not be situated in the proximity of fresh food stores and food preparation areas;
- have a supply of cleaning equipment, protective clothing and waste bags or containers located conveniently close to the storage area;
- have a washing basin with running tap water and soap that is readily available for the staff;
- be cleaned regularly (at least once per week);
- have spillage containment equipment;
- be appropriate to the volumes of waste generated from each health-care facility.

7.6.1 General requirements

A storage location for health-care waste should be designated inside the health-care facility. Space for storing wastes should be incorporated into a building design when new construction is undertaken; for an example, see the *Guidelines for design and construction of hospitals and health care facilities* (Facility Guidelines Institute, 2010). These storage areas should be sized according to the quantities of waste generated and the frequency of collection. The areas must be totally enclosed and separate from supply rooms or food preparation areas. Loading docks, space for compactors and balers for cardboard, staging areas for sharps boxes, recycling containers and secure storage (e.g. for batteries) should all be provided.

Storage facilities should be labelled in accordance with the hazard level of the stored waste. Figures 7.8 and 7.9 show typical signs advising the hazard posed by waste. In general, there are four different kinds of waste-storage areas:

- non-hazardous or general waste
- hazardous waste
- infectious and sharps waste
- chemical and hazardous pharmaceutical waste
- radioactive waste.



No entry for unauthorized persons for all storage areas



Biohazard sign for infectious and sharps waste



Toxic sign for chemical and hazardous pharmaceutical waste

Figure 7.8 Example labels outside the storage facility

Figure 7.9 illustrates the signs that should be displayed inside the storage facilities.



No eating or drinking



No smoking

Figure 7.9 Example labels inside the storage facility

7.6.2 Hazardous waste storage

Further specifications should be considered for the storage of hazardous waste, in addition to the general requirements.

Infectious waste storage

The storage place must be identified as an infectious waste area by using the biohazard sign. Floors and walls should be sealed or tiled to allow easy disinfection. If present, the storage room should be connected to a special sewage system for infectious hospital wastewater. The compacting of untreated infectious waste or waste with a high content of blood or other body fluids destined for offsite disposal (for which there is a risk of spilling) is not permitted. Sharps can be stored without problems, but other infectious waste should be kept cool or refrigerated at a temperature preferably no higher than 3 °C to 8 °C if stored for more than a week. Unless a refrigerated storage room is available, storage times for infectious waste (e.g. the time gap between generation and treatment) should not exceed the following periods:

- temperate climate
 - 72 hours in winter
 - 48 hours in summer
- warm climate
 - 48 hours during the cool season
 - 24 hours during the hot season.

Pathological waste storage

Pathological waste and the growth of pathogens it may contain are considered as biologically active waste, and gas formation during storage should be expected. To minimize these possibilities, the storage places should have the same conditions as those for infectious and sharps wastes.

In some cultures, body parts are passed to the family for ritual procedures or are buried in designated places. They should be placed in sealed bags to reduce infection risks before release to the public. More information about pathological waste handling can be found in Chapter 8 and in Annex 6. Figure 7.10 shows an example of a label for a pathological waste storage room.



Figure 7.10 Label for a pathological waste storage room

Pharmaceutical waste storage

Pharmaceutical waste should be segregated from other wastes and local regulations followed for final disposal. In general, pharmaceutical wastes can be hazardous or non-hazardous, and liquid or solid in nature, and each should be handled differently. The classification should be carried out by a pharmacist or other expert on pharmaceuticals. The pharmaceutical waste streams that are listed below can be distinguished (WHO, 1999):

- Pharmaceutical waste with non-hazardous characteristics that can be stored in a non-hazardous storage area
 - ampoules with non-hazardous content (e.g. vitamins);
 - fluids with non-hazardous contents, such as vitamins, salts (sodium chloride), amino salts;
 - solids or semi-solids, such as tablets, capsules, granules, powders for injection, mixtures, creams, lotions, gels and suppositories;
 - aerosol cans, including propellant-driven sprays and inhalers.
- Hazardous waste that should be stored in accordance with their chemical characteristics (e.g. genotoxic drugs) or specific requirements for disposal (e.g. controlled drugs or antibiotics)
 - controlled drugs (should be stored under government supervision);
 - disinfectants and antiseptics;
 - anti-infective drugs (e.g. antibiotics);
 - genotoxic drugs (genotoxic waste);
 - ampoules with, for example, antibiotics.

Genotoxic waste is highly toxic and should be identified and stored carefully away from other health-care waste in a designated secure location. It can be stored in the same manner as toxic chemical waste, although some cytotoxic waste may also carry a risk of infection.

Chemical waste storage

When planning storage places for hazardous chemical waste, the characteristics of the different chemicals to be stored and disposed of must be considered (inflammable, corrosive, explosive). The storage place should be an enclosed area and separated from other waste storage areas (Figure 7.11). When storing liquid chemicals, the storage should be equipped with a liquid- and chemical-proof sump. If no sump is present, catch-containers to collect leaked liquids should be placed under the storage containers. Spillage kits, protective equipment and first-aid equipment (e.g. eye showers) should be available in the central storage area. The storage area itself should have adequate lighting and good ventilation to prevent the accumulation of toxic fumes.

To ensure the safe storage of chemical wastes, the following separate storage zones should be available to prevent dangerous chemical reactions. The storage zones should be labelled according to their hazard class. If more than one hazard class is defined for a specific waste, use the most hazardous classification:

- explosive waste
- corrosive acid waste
- corrosive alkali waste (bases)
- toxic waste
- flammable waste
- oxidative waste
- halogenated solvents (containing chlorine, bromine, iodine or fluorine)
- non-halogenated solvents.

Liquid and solid waste should be stored separately. If possible, the original packaging should be taken for storage too. The packaging used to store and transport chemical wastes offsite should also be labelled. This label should have the following information: hazard symbol(s), waste classification, date, and point of generation (if applicable).

The storage area for explosive or highly flammable materials must be suitably ventilated above and below, with a bonded floor and constructed of materials suitable to withstand explosion or leakage.



Advanced storage of chemicals in different safety compartments



Storage of liquid chemical waste in chemical-resistant plastic containers



Safety cabinet for flammable substances



Inside a safety cabinet for flammable substances

Figure 7.11 Examples of storage places for chemical waste

Radioactive waste

Radioactive waste should be stored in containers that prevent dispersion of radiation, and stored behind lead shielding. Waste that is to be stored during radioactive decay should be labelled with the type of radionuclide, date, period of time before full decay and details of required storage conditions.

The decay storage time for radioactive waste differs from other waste storage, because the main target will be to store the waste until the radioactivity is substantially reduced and the waste can be safely disposed of as normal waste. A minimum storage time of 10 half-life times for radioisotopes in wastes with a half-life of less than 90 days is a common practice. Infectious radioactive waste should be decontaminated before disposal. Sharp objects such as needles, Pasteur pipettes and broken glass should be placed into a sharps container. Liquids associated with solid materials, such as assay tube contents, should be decanted or removed by decay time. All radioactive labelling should be removed on any items to be disposed of. Box 7.2 gives a sample calculation of decay storage time.

Box 7.2 Decay storage of radioactive waste – a sample calculation of decay storage time

Decay storage

Cr-51, Ga-67, I-125, I-131, In-111, P-32, Rb-86, Rd-222, S-35, Tc-99m and so on

Example

I-125

Half-life: 60.2 days (<90 days)

$60.2 \text{ days} \times 10 = 602 \text{ days of decay storage}$

Sources: IAEA (2005); FIU (2005)

Radioactive waste with a half-life of more than 90 days must be collected and stored externally in accordance with national regulations. In many countries, this type of waste would be taken to a national disposal site by a government agency or its specialist contractor.

Storage places must be equipped with sufficient shielding material, either in the walls or as movable shielding screens. The storage must be clearly marked with “RADIOACTIVE WASTE”, and the international hazard label should be placed on the door. The storage place should be constructed in a manner that renders it flame-proof and should have such surfaces on floors, benches and walls that allow proper decontamination. An air-extraction system and radioactive monitoring system should be put in place. The International Atomic Energy Agency provides comprehensive guidance on all aspects of the safety of radioactive waste management in the Safety Standards Series.

7.6.3 Layout of waste-storage areas

If new health-care waste-management systems are developed and if new infrastructure is planned, a “waste yard” should be built. A waste yard is where all the relevant waste-management activities are brought together. To concentrate certain tasks, it is best to set up multifunctional buildings (waste-storage area), including a fenced storage area for general waste (A), a room for infectious waste (B), a treatment room (C), a fenced area with an ash or sharps pit (D), a container cleaning room (E) and a clean office with lockers and toilets (F).

A sample design of a storage room for chemical waste is presented in Figures 7.12 and 7.13.

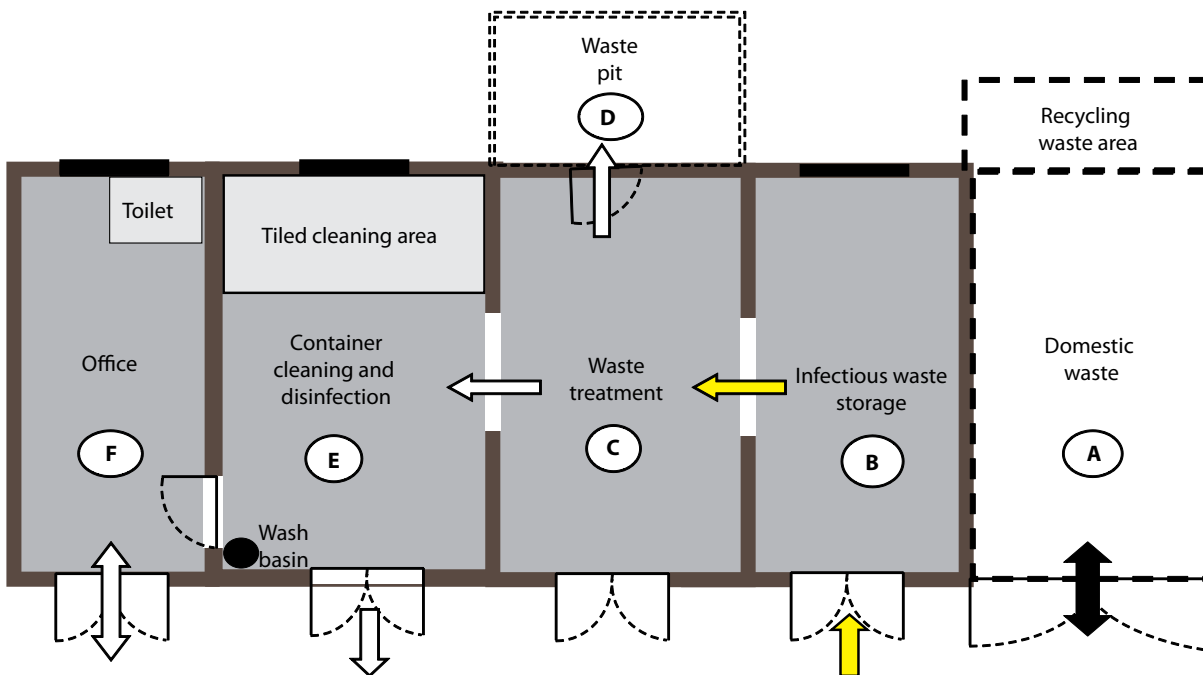

Figure 7.12 Sketch of waste-storage area

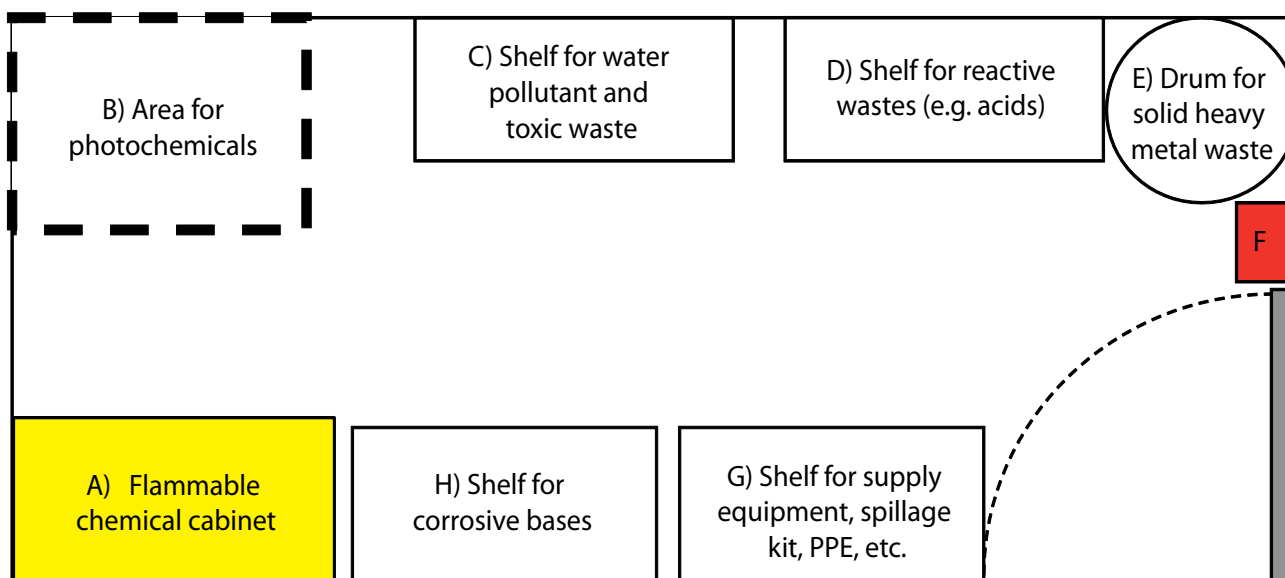

Figure 7.13 Sample outline of chemical storage room

7.6.4 Documentation of the operation of storage places

Keeping clear records of the wastes stored and their treatment and disposal dates is important to ensure a good control of waste management. Some countries have strict legal requirements to achieve a high level of safety. The following forms of additional documentation are suggested:

- a written spill contingency plan;
- a weekly store inspection protocol;
- protocols for using, repairing and replacing emergency equipment;
- training system and documentation (names of trained staff, job descriptions, form of training, date of training, date for refresher or revalidation training);
- hazardous waste storage documentation;
- collection of relevant material safety data sheets.

7.7 Offsite transport of waste

Offsite transport is the carriage of health-care waste on the public streets away from a health-care facility. Transporting hazardous health-care waste should comply with national regulations, and with international agreements if wastes are shipped across an international frontier for treatment (Secretariat of the Basel Convention, 1992). Where there are no national regulations, responsible authorities may refer to recommendations on the transport of dangerous goods published by the United Nations. These are available in English, French, Spanish, Russian, Arabic and Chinese (UN, 2009).¹²

¹² See http://www.unece.org/trans/danger/publi/unrec/rev16/16files_e.html

7.7.1 Logistic staff

Drivers of vehicles carrying hazardous health-care waste should have appropriate training about risks and handling of hazardous waste. Training on the following issues should be included:

- relevant legal regulations
- waste classifications and risks
- safe handling of hazardous waste
- labelling and documentation
- emergency and spillage procedures.

In addition, drivers should be declared medically fit to drive vehicles.

In case of accident, contact numbers or details of the emergency services and other essential departments should be carried in the driver's cab. For safety reasons, vaccination against tetanus and hepatitis A and B is recommended, and vaccination and training details of staff should be recorded.

7.7.2 Vehicle requirements

A fundamental requirement is for the vehicle transporting hazardous waste to be roadworthy and labelled to indicate its load, and its payload to be secured to minimize the risk of accidents and spillages. Any vehicle used to transport health-care waste should fulfil several design criteria:

- The body of the vehicle should be of a suitable size commensurate with the design of the vehicle.
- There should be a bulkhead between the driver's cabin and the vehicle body, which is designed to retain the load if the vehicle is involved in a collision.
- There should be a suitable system for securing the load during transport.
- Empty plastic bags, suitable protective clothing, cleaning equipment, tools and disinfectant, together with special kits for dealing with liquid spills, should be carried in a separate compartment in the vehicle.
- The internal finish of the vehicle should allow it to be steam-cleaned and internal angles should be rounded to eliminate sharp edges to permit more thorough cleaning and prevent damage to waste containers.
- The vehicle should be marked with the name and address of the waste carrier.
- An international hazard sign should be displayed on the vehicle and containers, as well as an emergency telephone number.
- The driver should be provided with details of the waste being carried.

An example of a specially designed vehicle used for transporting health-care waste is shown in Figure 7.14. Vehicles or containers used for transporting health-care waste should not be used for transporting any other material. Vehicles should be kept locked at all times, except when loading and unloading, and kept properly maintained. Articulated or demountable trailers (temperature-controlled if required) are particularly suitable, because they can easily be left at the site of waste production. Other systems may be used, such as specially designed large, closed containers or skips. Open-topped skips or containers are unsuitable because they fail to isolate waste from the general public during transportation, and should not be used for health-care waste.

Where the use of a dedicated vehicle cannot be justified, a bulk container that can be lifted onto a vehicle chassis may be considered. The container may be used for storage at the health-care facility and replaced with an empty one when collected. Refrigerated containers could be used if the storage time exceeds the recommended limits described previously, or if transportation times are long. The same safety measures should apply to the collection of hazardous health-care waste from scattered small sources, such as clinics and general practice surgeries.



Photo source: BioServ Inc.

Figure 7.14 Example of a vehicle used for transporting health-care waste in the United Kingdom

7.7.3 Labelling of the transport vehicle

The transport vehicle should be labelled according to the type of waste that is being transported. The label that is displayed will depend on the United Nations classification of the waste. Relevant examples are shown in Table 7.3.

Table 7.3 Selected United Nations packaging symbols









UN class	Name	Description of symbol	Symbol
3.1	Flammable Liquids	Black symbol: flame Background: red Class "3" in bottom corner	
5.1	Oxidizing Substances	Black symbol: flame over circle Background: yellow Class "5.1" in bottom corner	
6.1	Toxic Substances	Black symbol: skull and crossbones Background: white Class "6" in bottom corner	

Table 7.3 continued

UN class	Name	Description of symbol	Symbol
6.2	Infectious Substances	Black symbol: three crescents superimposed on a circle Background: white Class "6" in bottom corner	
7A	Radioactive Material Category I – White	Black symbol: trefoil Background: white Class "7" in bottom corner	
7B	Radioactive Material Category II – Yellow	Black symbol: trefoil Background: yellow Class "7" in bottom corner	
7C	Radioactive Material Category III – Yellow	Black symbol: trefoil Background: yellow Class "7" in bottom corner	
8	Corrosive Substances Category I – White	Black symbol: liquids spilling from two glass vessels and attacking a hand and a metal Background: upper half white, lower half black with white border Class "8" in bottom corner	
9	Miscellaneous Dangerous Substances Category I – White	Black symbol: seven vertical stripes in upper half Background: white, lower half black with white border Class "9" underlined in bottom corner	

Example: Labelling of a vehicle transporting infectious waste, sharps or pathological waste

No specific vehicle labelling is required if less than 333 kg (i.e. the “gross dangerous goods charge”) of infectious waste (UN 3291) is transported – although labelling is recommended. Vehicles transporting more than 333 kg gross weight must be provided with warning plates, as represented in Figure 7.15.

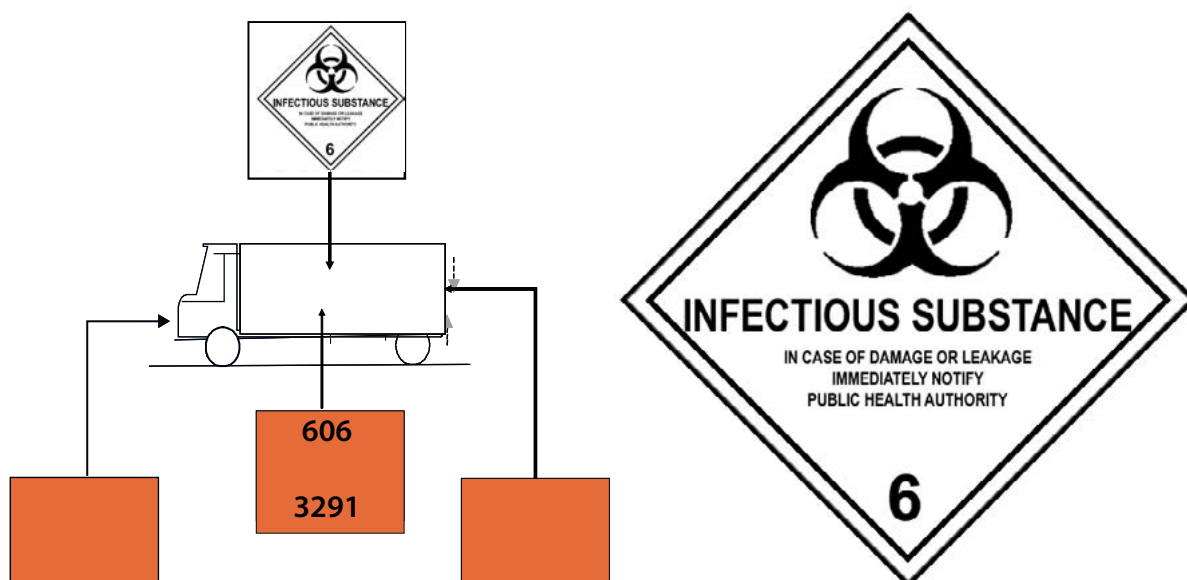

Figure 7.15 Specifications for placards (e.g. UN 3291 Infectious [Biomedical] Waste)

A warning plate should:

- be not less than 250 mm by 250 mm, with a line of the same colour as the symbol running 12.5 mm inside the edge and parallel with it;
- correspond to the label required for the dangerous goods in question with respect to colour and symbol;
- display the numbers prescribed for the dangerous goods on the corresponding label, in digits not less than 25 mm high.

7.7.4 Cleaning of container and vehicle

Vehicles and transporting containers used for the transportation of waste should be cleaned and disinfected daily after use. Mechanical cleaning, combined with soaps and detergents, which act as solubility promoting agents, can be used. Cleaning and disinfection have to be carried out in a standardized manner or by automated means that will guarantee an adequate level of cleanliness. A standard operating procedure for cleaning should be prepared and explained to cleaning staff. In addition, a schedule for preventive maintenance should be set up for all equipment and vehicles used in the transportation process.

7.7.5 Transport documentation

Before sending hazardous health-care wastes offsite, transport documentation (commonly called a “consignment note” or “waste tracking note”) should be prepared and carried by the driver. A consignment note should be designed to take into account the control system for waste transportation in operation within a country. If a waste regulatory authority is sufficiently well established, it may be possible to pre-notify the agency about a planned offsite transport and disposal of hazardous health-care waste and to obtain the agency’s approval. Anyone involved in the production, handling or disposal of health-care waste should recognize that they have a general “duty of care” – that is, an obligation to ensure that waste handling, treatment and disposal and the associated documentation comply with the national regulations.

The consignment note for a vehicle carrying a hazardous health-care waste load should include the following information in case of accidents or official inspection:

- waste classes
- waste sources
- pick-up date

- destination
- driver name
- number of containers or volume
- receipt of load received from responsible person at pick-up areas.

This information allows quick and effective countermeasures to be taken in the event of an accident or incident. Weight of waste is useful for commercial treatment and disposal operators who bill health-care facilities for their waste services.

On completion of a journey, the transporter should complete a consignment note and return it to the waste producer. A typical consignment note for carriage and disposal of hazardous waste and routing of the copies to a waste producer, waste disposer and regulator is shown in Figure 7.16.

There are four copies of the signed consignment note: one for the generator and one for the transport entity, one for the treatment entity and one for the relevant regulatory authority.

Consignment note in accordance with ADR

Date of collection:

(Day, Month, Year)

 Consignor (generator) – name and address

 Waste carrier – name and address

Date of receipt:

(Day, Month, Year)

 Consignee (treatment site) – name and address

Waste description:

UN No. and type packaging	Proper shipping name	Gross weight (kg)

I hereby declare that the contents of the consignment are fully and accurately described above by the proper shipping name and are classified, packaged, marked and labelled/placarded and are in all respects in proper condition according to applicable international and national governmental regulations. I declare that all of the applicable requirements have been met.

 Signature Consignor
 (Generator)

 Signature Waste Carrier
 (Transport)

 Signature Consignee
 (Treatment Site)

Figure 7.16 Example of consignment note for carriage and disposal of infectious waste

To reduce the negative impacts of accidents, contact telephone numbers of the emergency services and environmental and public health regulators should be given to drivers.

7.8 Minimum approach to segregation, storage and transport

The minimum standard to segregating health-care wastes is the “three-bin system”, where separate containers are provided for infectious waste, used sharps and general waste.

The basic features of a minimal level of waste segregation and storage are as follows:

- Wastes are segregated at their place of production to reduce the health risk from the smaller potentially infectious fractions (typically waste items contaminated with body fluids and used sharps).
- Infectious waste, general waste and used sharps waste are stored in separate colour-coded containers and locations within medical areas, and subsequently at a central storage site at a health-care facility.
- Central storage area(s) are fenced, lockable and isolated from patients and the public.
- Maximum storage times before treatment or disposal of infectious waste are not longer than
 - temperate climate: 72 hours in winter and 48 hours in summer
 - warm climate: 48 hours during the cooler season and 24 hours during the hot season.
- Staff receive instruction on three-bin waste segregation and safe handling and storage of health-care wastes.
- Staff are aware of how to protect themselves from injuries and infection from waste.
- Waste containers and storage areas are cleaned regularly.

The minimum measures for transporting health-care wastes are as follows:

- General waste and infectious health-care waste is collected separately and at least once a day.
- Collection is at regular times and is reliable.
- Waste containers and onsite transport trolleys are closed with lids to isolate wastes from patients and the public.
- Where wastes are transported offsite for disposal, the vehicle is able to carry wastes in a closed or covered container, and the driver knows what to do if there is an accident or incident during transportation on public roads.
- Transport staff are vaccinated at least against hepatitis A and B, polio and tetanus.
- Waste containers, trolleys and vehicles are maintained and cleaned regularly.

In emergency situations, all waste from patients arriving at a health-care facility could be classified as potentially infectious to minimize the transmission of secondary infection.

7.9 Desirable improvements to the minimal approach

Enhancements of the minimal approach include:

- developing more detailed arrangements for waste storage and transport in a waste-management plan;
- exploring opportunities for reducing, reusing and recycling some portions of the health-care wastes produced at the facility;
- including waste-storage and transport expenses in the annual budgeting;
- instituting separate chemical and pharmaceutical waste segregation and storage management;
- developing a separate storage and documentation system for chemical wastes, which could include separate storage zones for:
 - flammable liquids
 - bio-toxic compounds
 - corrosive wastes – acids

- caustic wastes – bases
- chemical waste management included in training activities.

7.10 References and further reading

References

Ahmed S (2010). *A randomized controlled trial of use of needle removal devices during routine immunization in Bangladesh, 2009–2010*. Report of the Annual Safe Injection Global Network (SIGN) meeting, 9–11 November 2010, Dubai. Geneva, SIGN and World Health Organization (http://www.who.int/injection_safety/sign/en).

Facility Guidelines Institute (2010). *Guidelines for design and construction of hospital and health care facilities*. Chicago, American Society for Healthcare Engineering of the American Hospital Association.

FIU (Florida International University) (2005). *Radiation safety manual*. Miami, Department of Environmental Health & Safety & Risk Management Services, Florida International University.

IAEA (International Atomic Energy Agency) (2005). *Application of the concepts of exclusion, exemption and clearance*, IAEA Safety Standards Series, no. RS-G-1.7. Vienna, International Atomic Energy Agency.

MoHSW (Ministry of Health and Social Welfare) (2006). *Standards and procedures for health care waste management in Tanzania*. The United Republic of Tanzania, Ministry of Health and Social Welfare.

Secretariat of the Basel Convention (1992). *Technical guidelines on environmentally sound management of biomedical and health care waste*. Geneva, Secretariat of the Basel Convention on the Control of Transboundary Movements of Hazardous Wastes and their Disposal/United Nations Environment Programme.

UN (United Nations) (2009). *UN recommendations on the transport of dangerous goods*, 16th ed. Geneva, United Nations (http://www.unece.org/trans/danger/publi/unrec/rev16/16files_e.html).

UN (2010). *European agreement concerning the international carriage of dangerous goods by road: ADR*. Geneva, United Nations.

WHO (World Health Organization) (1999). *Guidelines for safe disposal of unwanted pharmaceuticals in and after emergencies*. Geneva, World Health Organization.

WHO (2007). *PQS performance specification*. Report no. WHO/PQS/E10/SB01.1. Geneva, World Health Organization (http://www.who.int/immunization_standards/vaccine_quality/who_pqs_e10_sb01.pdf).

Further reading

LWRA (London Waste Regulation Authority) (1989). *Guidelines for the segregation, handling and transport of clinical waste*. London, LWRA.

Rushbrook P, Zghondi R (2005). *Better health care waste management: an integral component of health investment*. Cairo, World Health Organization Eastern Mediterranean Regional Office.

Secretariat of the Basel Convention (1999). *Eleven recommendations for improving medical waste management*. Geneva, Technical Working Group of the Basel Convention by the Basel Action Network (BAN).

Secretariat of the Basel Convention (2002). *Technical guidelines on environmentally sound management of biomedical and health care waste*. Geneva, Secretariat of the Basel Convention on the Control of Transboundary Movements of Hazardous Wastes and their Disposal/United Nations Environment Programme.

Secretariat of the Basel Convention (2003). *Technical guidelines on the environmentally sound management of biomedical and health care wastes (Y1; Y3)*. Basel Convention series/SBC No. 2003/3. Châtelaine, Secretariat of the Basel Convention/United Nations Environment Programme.

Secretariat of the Basel Convention, WHO (World Health Organization) (2005). *Preparation of national health care waste management plans in sub-Saharan countries: guidance manual*. Geneva, Secretariat of the Basel Convention/WHO (available at http://www.basel.int/pub/techguid/gm_hc_sussahara_e.pdf).

UNECE (United Nations Economic Commission for Europe) (2010). *European Agreement concerning the international carriage of dangerous goods by road (ADR applicable from 1 January 2011)*. Geneva, United Nations (<http://www.unece.org/trans/danger/publi/adr/adr2011/11contentse.html>).

UNEP (United Nations Environment Programme) (1992). *Basel Convention on the Control of Transboundary Movements of Hazardous Wastes and their Disposal*. Geneva, Secretariat of the Basel Convention.

WHO (World Health Organization) (2000). *Starting health care waste management in medical institutions: a practical approach*. Report EUR/00/5021817. Copenhagen, World Health Organization Europe Region.

8

Treatment and disposal methods

Key questions to answer

What forms of treatment technologies are available for health-care waste?

What are the variables to consider when selecting a treatment technology?

How does one ensure proper treatment?

Is there an annual budget for testing and preventive maintenance of the waste-treatment technology?

What safeguards are needed for the land burial of health-care waste?

The purpose of treatment is to reduce the potential hazard posed by health-care waste, while endeavouring to protect the environment.

Treatment should be viewed in the context of the waste-management hierarchy described in Chapter 6. Measures should first be followed to minimize and reuse waste items where it is safe to do so. Where this is not possible, the unusable waste materials should preferably be treated to reduce their potential health or environmental hazard and volume, with remaining residues sent for land disposal to a suitably constructed site.

8.1 Selection of treatment methods

The choice of treatment system involves consideration of waste characteristics, technology capabilities and requirements, environmental and safety factors, and costs – many of which depend on local conditions. Factors to consider include:

- waste characteristics
- quantity of wastes for treatment and disposal
- capability of the health-care facility to handle the quantity of waste
- types of waste for treatment and disposal
- technology capabilities and requirements
- local availability of treatment options and technologies
- capacity of the system
- treatment efficiency
- volume and mass reduction
- installation requirements
- available space for equipment
- infrastructure requirements
- operation and maintenance requirements
- skills needed for operating the technology
- environmental and safety factors
- environmental releases

- location and surroundings of the treatment site and disposal facility
- occupational health and safety considerations
- public acceptability
- options available for final disposal
- regulatory requirements
- cost considerations
- equipment purchase cost
- shipping fees and customs duties
- installation and commissioning costs
- annual operating costs, including preventive maintenance and testing
- cost of transport and disposal of treated waste
- decommissioning costs.

There are five basic processes for the treatment of hazardous components in health-care waste, in particular, sharps, infectious and pathological wastes: thermal, chemical, irradiation, biological and mechanical.

8.2 Overview of waste-treatment technologies

8.2.1 Thermal processes

These processes rely on heat (thermal energy) to destroy pathogens in the waste. They represent most treatment facilities in use across the world. This category can be further subdivided into low-heat and high-heat designs. This subclassification is useful because of the marked differences in the thermochemical reactions and physical changes taking place in the wastes during their treatment in the different types of equipment. These differences produce very different atmospheric emissions characteristics.

Low-heat thermal processes are those that use thermal energy at elevated temperatures high enough to destroy microorganisms but not sufficient to cause combustion or pyrolysis of the waste. Pyrolysis is the thermal degradation of a substance through the application of heat in the absence of oxygen. Pyrolysis is a special case of thermolysis, and is most commonly used for organic materials. It occurs at high temperatures but does not involve reactions with oxygen. In practice, it is difficult to have a completely oxygen-free atmosphere, so some oxidation takes place.

In general, low-heat thermal technologies operate between 100 °C and 180 °C. The low-heat processes take place in either moist or dry-heat environments. Moist (or wet) thermal treatment involves the use of steam to disinfect waste and is commonly performed in an autoclave or steam-based treatment system. Microwave treatment is essentially a moist thermal process, because disinfection occurs through the action of moist heat (hot water and steam) generated by the microwave energy. Dry-heat processes use hot air without the addition of water or steam. In dry-heat systems, the waste is heated by conduction, convection and/or thermal radiation using infrared or resistance heaters.

8.2.2 Chemical processes

Chemical treatment methods use disinfectants such as dissolved chlorine dioxide, bleach (sodium hypochlorite), peracetic acid, lime solution, ozone gas or dry inorganic chemicals (e.g. calcium oxide powder). Chemical processes often involve shredding, grinding or mixing to increase exposure of the waste to the chemical agent. In liquid systems, the waste may go through a dewatering section to remove and recycle the disinfectant. Besides chemical disinfectants, there are also encapsulating compounds that can solidify sharps, blood or other body fluids within a solid matrix before disposal. Another example of a chemical process is a system that uses heated alkali to digest tissues, pathological waste, anatomical parts and animal carcasses in heated stainless-steel tanks.

8.2.3 Irradiation technologies

Irradiation treatment encompasses designs using irradiation from electron beams, cobalt-60 or ultraviolet sources. These technologies require shielding to prevent elevated occupational exposures to electromagnetic radiation. The pathogen destruction efficacy depends on the dose absorbed by the mass of waste. Electron beams are powerful enough to penetrate waste bags and containers. Germicidal ultraviolet radiation has been used to destroy airborne microorganisms as a supplement to other treatment technologies, but is not able to penetrate closed waste bags.

8.2.4 Biological processes

These processes are found in natural living organisms but refer specifically to the degradation of organic matter when applied to health-care waste treatment. Some biological treatment systems use enzymes to speed up the destruction of organic waste containing pathogens. Composting and vermiculture (digestion of organic wastes through the action of worms) are biological processes and have been used successfully to decompose hospital kitchen waste, as well as other organic digestible waste (Mathur, Verma & Srivastava, 2006) and placenta waste. The natural decomposition of pathological waste through burial is another example of a biological process. More detailed information can be found in Annex 6.

8.2.5 Mechanical processes

Mechanical treatment processes include several shredding, grinding, mixing and compaction technologies that reduce waste volume, although they cannot destroy pathogens. In most instances, mechanical processes are not stand-alone health-care waste-treatment processes, but supplement other treatment methods. Mechanical destruction can render a waste unrecognizable and can be used to destroy needles and syringes (depending on the type of shredding). In the case of thermal or chemical treatment processes, mechanical devices such as shredders and mixers can also improve the rate of heat transfer or expose more surface area of waste to waste treatment. Mechanical devices used to prepare wastes before other forms of waste destruction add significantly to the level of management and maintenance required to treat health-care waste safely and efficiently.

Unless shredders, mixers and other mechanical devices are an integral part of a closed treatment system, they should not be used before the incoming health-care waste is disinfected. If they are used, workers are at an increased risk of being exposed to pathogens in aerosols released into the environment by mechanical destruction of untreated waste bags. If mechanical processes are part of a closed system, the technology should be designed in such a way that the air in and from the mechanical process is disinfected before being released to the surroundings.

8.3 Suitability of treatment methods for infectious waste

The largest proportion of hazardous health-care waste generated is potentially infectious. The most established waste-management technologies focus on disinfection. Methods for dealing with other waste streams are discussed later in this chapter (see section 8.11). Disinfection can be defined as the reduction or removal of disease-causing microorganisms (pathogens) to minimize the potential for disease transmission.

Sterilization is defined as the destruction of all microbial life. Since the complete destruction of all microorganisms is difficult to establish, sterilization of medical and surgical instruments is generally expressed as a $6 \log_{10}$ reduction (i.e. a 99.9999% reduction) or greater of a specified microorganism that is highly resistant to the treatment process. A $6 \log_{10}$ reduction, sometimes also written as “log 6 kill”, corresponds to a one millionth (0.000001) survival probability of the microbial population.

The State and Territorial Association on Alternate Treatment Technologies (STAATT) classification system, in lieu of the terms disinfection or sterilization, denotes levels of “microbial inactivation” specifically for health-care waste treatment.¹³ The classification system was established to define measures of performance of health-care waste treatment technologies. The levels defined for microbial inactivation are:

- Level I: inactivation of vegetative bacteria, fungi and lipophilic viruses at a $6 \log_{10}$ reduction or greater;

¹³ See <http://www.istaatt.org>

- Level II: inactivation of vegetative bacteria, fungi, lipophilic/hydrophilic viruses, parasites and mycobacteria at a 6 log₁₀ reduction or greater;
- Level III: inactivation of vegetative bacteria, fungi, lipophilic/hydrophilic viruses, parasites and mycobacteria at a 6 log₁₀ reduction or greater; and inactivation of *Geobacillus stearothermophilus* spores and *Bacillus atrophaeus* spores at a 4 log₁₀ reduction or greater;
- Level IV: inactivation of vegetative bacteria, fungi, lipophilic/hydrophilic viruses, parasites, mycobacteria and *Geobacillus stearothermophilus* spores at a 6 log₁₀ reduction or greater.

A common microbial inactivation standard for health-care waste treatment based on the STAATT criteria is Level III. Regular testing of the efficacy of disinfection techniques is important. Countries may have different protocols, but general guidelines and procedures are available; for example, STAATT testing procedures, which are kept under constant review.¹⁴

8.4 Steam treatment technologies

8.4.1 Autoclaves

Autoclaves are capable of treating a range of infectious waste, including cultures and stocks, sharps, materials contaminated with blood and limited amounts of fluids, isolation and surgery waste, laboratory waste (excluding chemical waste) and “soft” waste (including gauze, bandages, drapes, gowns and bedding) from patient care. With sufficient time and temperature, it is technically possible to treat small quantities of human tissue, but ethical, legal, cultural, religious and other considerations may preclude their treatment. Autoclaves are generally not used for large anatomical remains (body parts), because it is difficult to determine beforehand the time and temperature parameters needed to allow full penetration of heat to the centre of the body part.

Autoclaves have been used for more than a century to sterilize medical instruments, and for several years they have been adapted for the treatment of infectious waste. An autoclave consists of a metal vessel designed to withstand high pressures, with a sealed door and an arrangement of pipes and valves through which steam is introduced into, and removed from, the vessel. Some autoclaves are designed with a steam jacket surrounding the vessel; steam is introduced into both the outside jacket and the inside chamber. Heating the outside jacket reduces condensation on the inside chamber wall and allows the use of steam at lower temperatures. An autoclave without a steam jacket, sometimes called a “retort”, is commonly found in large-scale applications and is cheaper to construct.

Air is an effective insulator and a principal factor in determining the efficiency of steam treatment. Removal of air from the autoclave is essential to ensure penetration of heat into the waste. Unlike instrument sterilization autoclaves, waste-treatment autoclaves must treat the air that is removed at the start of the process to prevent the release of pathogenic aerosols. This is usually done by treating the air with steam or passing it through a high-efficiency particulate air (HEPA) filter before it is released.

Consequently, autoclaves can be subcategorized according to the method of air removal. The three common types are:

- gravity-displacement autoclaves
- pre-vacuum or high-vacuum autoclaves
- pressure pulse autoclaves.

A gravity-displacement autoclave takes advantage of the fact that steam is lighter than air. Hence, steam is introduced under pressure into the chamber, forcing the air downwards into an outlet port of the chamber.

¹⁴ See <http://www.epa.gov/osw/nonhaz/industrial/medical/publications.htm>

A more effective but costlier method is the use of a vacuum pump and/or a steam ejector to evacuate air before introducing steam, as is done in pre-vacuum (also called high-vacuum) autoclaves. Pre-vacuum autoclaves need less time for disinfection due to their greater efficiency in removing air and disinfecting waste. Figure 8.1 shows a simple schematic of a pre-vacuum autoclave.

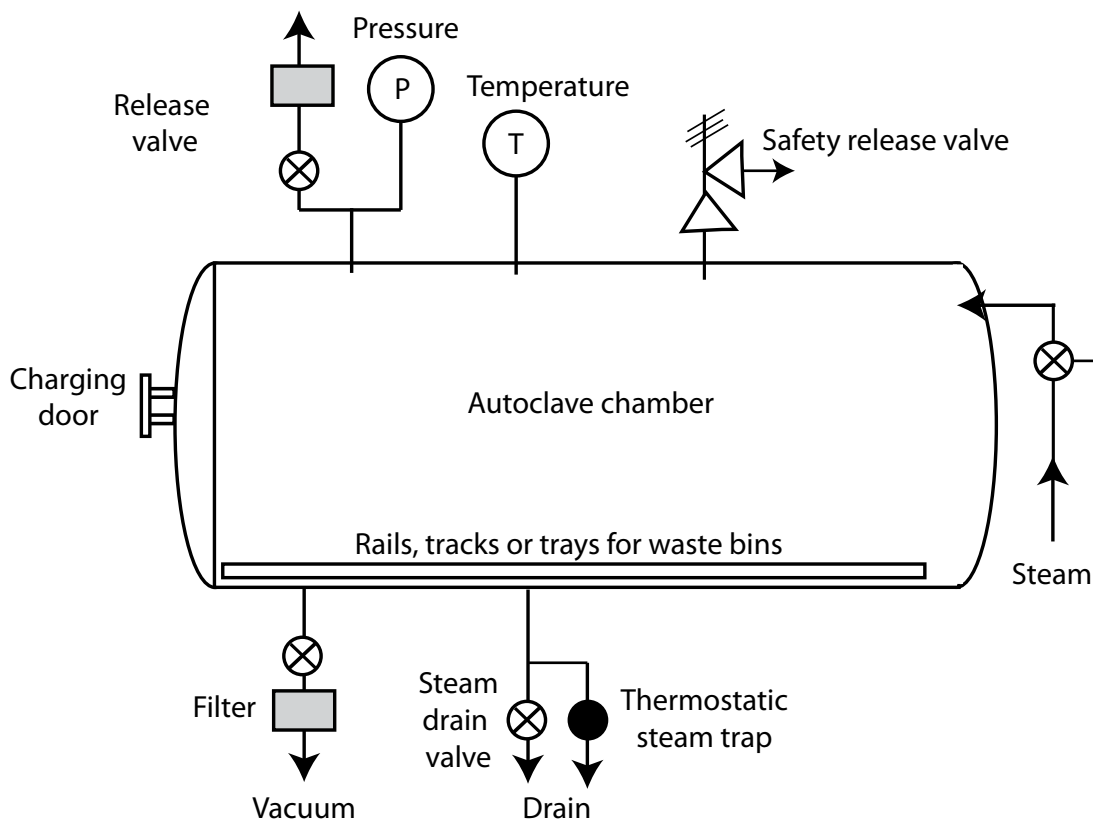

Source: Jorge Emmanuel

Figure 8.1 Simplified schematic of a pre-vacuum autoclave

Other autoclaves use pressure pulsing to evacuate air. The three basic types of pressure pulsing systems are pressure gravity, vacuum pulsing and pressure-vacuum. Pressure gravity (or steam flushing) entails repeatedly releasing steam and reducing the pressure to near atmospheric after the pressure has reached a predetermined level and then allowing the pressure to build up again with the addition of steam. Vacuum pulsing is similar to a high-vacuum operation except that two or more vacuum cycles are used at the start of the treatment process. Pressure-vacuum systems operate by building pressure and then releasing a vacuum, and repeating this process several times during treatment. Alternating pressure cycles are used to achieve rapid penetration of steam. In general, the pressure-vacuum systems have the shortest time for achieving high disinfection levels.

Since autoclaves must be able to withstand repeated build-up and release of steam pressures, their construction materials, engineering design, fabrication, accuracy of pressure and temperature sensors, and testing must meet basic requirements to operate safely. Examples of international standards related to pressure vessels are EN 13445, EN 285 and ASME Section VIII (see the list of references and further reading at the end of this chapter). For waste treatment, autoclaves should be rated to operate between 1 and 2 bar gauge pressure (about 15–30 psig, or 1540–2280 mm Hg absolute) or higher.

Waste-treatment autoclaves can range in size from about 20 litres to more than 20 000 litres. Low-heat thermal processes produce significantly less air pollution emissions than high-heat thermal processes. Consequently, there are no specific pollutant emission limits for autoclaves and other steam treatment systems.

A typical operation for an autoclave involves the following:

- **Waste collection:** Infectious waste bags are placed in a metal cart or bin. The cart or bin should be lined with a plastic liner to prevent waste from sticking to the sides of the container.
- **Pre-heating** (for autoclaves with steam jackets): Steam is introduced into the outside jacket of the autoclave.
- **Waste loading:** The metal cart or bin is loaded into the autoclave chamber. With every load, a colour-changing indicator is attached to the outer surface of the waste bag in the middle of the waste load to monitor treatment. The entry (or charging) door is closed, sealing the chamber.
- **Air evacuation:** Air is removed through gravity displacement, pre-vacuuming or pulse vacuuming.
- **Steam treatment:** Steam is introduced into the chamber until the required pressure or temperature is reached. Additional steam is automatically fed into the chamber to maintain the temperature and pressure for a set time period. Pressure pulsing autoclaves vary the pressure according to a set process cycle.
- **Steam discharge:** Steam is vented from the chamber, usually through a condenser, to reduce the pressure and temperature. In some systems, a post-vacuum cycle is used to remove residual steam and to dry the waste.
- **Unloading:** Usually, additional time is provided to allow the waste to cool down further, after which the treated waste is removed and the indicator strip is checked. The process is repeated if the colour change on the indicator shows that the treatment cycle was insufficient.
- **Documentation:** A written log is maintained to record the date, time and operator name; type and approximate amount of waste treated; and post-treatment confirmation results from any automated equipment recording or temperature–pressure monitoring indicator, such as the indicator strip.
- **Mechanical treatment:** If desired, the treated waste may be fed into a shredder or compactor before disposal in a landfill.

Some options provided by autoclave manufacturers include programmable computer controls, tracks and lifts for carts, recording of treatment parameters, weighing scales, autoclave-compatible carts and cart washers, odour-reducing systems, sensors to detect radioactive or chemical wastes, and shredders. Certain load configurations, such as placing bags in multilevel racks with sufficient spaces between bags to allow more surfaces to be exposed to steam, are more efficient than tightly stacked containers or carts.

Volatile and semivolatile organic compounds, chemotherapeutic waste, mercury, other hazardous chemical waste and radiological waste should not be treated in an autoclave. Large and bulky bedding material, large animal carcasses, sealed heat-resistant containers and other waste loads that impede the transfer of heat should be avoided.

Odours can be a problem around autoclaves if there is insufficient ventilation. If waste streams are not properly segregated to prevent hazardous chemicals from being placed in the treatment chamber, toxic contaminants will be released into the air, as a condensate, or in the treated waste. This happens when waste loads contaminated with laboratory solvents or heavy metals such as mercury are put in the autoclave. Poorly segregated waste may emit low levels of alcohols, phenols, formaldehyde and other organic compounds into the air.

Treated waste from an autoclave retains its physical appearance. If desired, a mechanical process such as a shredder or grinder is used after treatment to make the waste unrecognizable. Shredding reduces the volume of the treated waste by 60–80%, but is prone to breakdowns.

The operation of autoclaves requires the proper combination of temperature/pressure and exposure time to achieve disinfection. In the past, a minimum recommended temperature–exposure time criterion of 121 °C for 30 minutes was suggested. This corresponds to a pressure of 205 kPa or 2.05 bar (15 psig or 30 psia). However, the effective penetration of steam and moist heat depends on many factors, including time, temperature/pressure, process sequence, load size, stacking configuration and packing density, types and integrity of bags or containers used, physical properties of the materials in the waste (such as bulk density, heat capacity and thermal conductivity), the amount of residual air and the moisture content in the waste (Lemieux et al., 2006). If liquids such as blood bags or urine bags are to be sterilized, the sterilization process and time have to be adapted. The Robert Koch Institute recommends treating prions, which cause Creutzfeld–Jacob disease, at 134 °C for 60 minutes because

of their exceptional resistance. For these reasons, initial challenge tests should be conducted using waste samples that are representative of actual waste produced in a health-care facility to determine or validate the minimum temperature, pressure and exposure time or pulsing cycle required to achieve the microbial inactivation standard.

After the initial tests, regular validation tests using biological indicators should be performed at periodic intervals (typically, every week, every 40 hours of use, or once a month, depending on usage). As an added check, colour-changing chemical indicators, such as strips that contain thermochromic agents (chemicals that change colour when they reach a given temperature) or integrators (indicators that respond to both time and temperature) can be used with each waste load to document that the required temperature has been achieved. Pre-vacuum and vacuum pressure pulse autoclaves also use Bowie-Dick test packs to detect air leaks and to monitor periodically the air removal system in the autoclave chamber.

8.4.2 Integrated steam-based treatment systems

A second generation of steam-based systems has been developed for the purpose of improving the transfer of heat into the waste, achieving more uniform heating of the waste, rendering the waste unrecognizable and/or making the treatment system a continuous (rather than a batch) process. These systems have sometimes been referred to as advanced autoclaves, hybrid autoclaves or advanced steam treatment technologies (Emmanuel, 2001; Emmanuel & Stringer, 2007).

These systems function as autoclaves but combine steam treatment with various kinds of mechanical processing before, during or after steam treatment. Examples include:

- steam treatment–mixing–fragmenting followed by drying and shredding
- internal shredding followed by steam treatment–mixing and then drying
- internal shredding–steam treatment–mixing followed by drying
- internal shredding followed by steam treatment–mixing–compaction.

Each of these systems operates differently, as explained in more detail in the following paragraphs. Nevertheless, they treat the same types of waste and have similar emission characteristics as an autoclave, and share many of the advantages and disadvantages.

Example 1: a system that combines steam treatment–mixing–fragmenting, drying, then shredding is a rotating autoclave with fixed internal vanes. The rotating autoclave is designed as a pressure vessel with a rotating internal drum. Waste bags and boxes are loaded into the drum. The initial step is a vacuum to remove air. The evacuated air is mixed with steam to destroy pathogens and passed through a condenser and filter. The rotating pressure chamber operates at about 147 °C for 30 minutes. The combined effects of the steam and the forces due to rotation, as containers are pushed against the vanes of the rotating drum and fall, cause boxes and bags to break up. The agitation also helps eliminate cold spots. After treatment, the steam is removed, passed through a condenser, and the condensate is discharged to the sewer while residual air is vented through a carbon filter to remove odours. The chamber is then cooled to dry the waste. Decontaminated waste is automatically unloaded by reversing the rotation and discharging the waste on to a conveyor. A post-treatment grinder further reduces waste volume down to about 20% of the original volume.

Example 2: an integrated steam-based treatment system uses a computer-controlled top-loading, double-walled vertical cylinder. After loading and closing of the lid, the waste is fed by a moving paddle into a heavy-duty internal shredder. The shredded material falls into the bottom portion of the vessel, where it is heated by steam to about 138 °C and a pressure of 3.8 bars. A treatment level corresponding to an 8 log₁₀ reduction of bacterial spores can be achieved. Cool water is then passed through the outside wall of the inner chamber to reduce temperature and pressure. After the water is drained, a vacuum removes residual steam from the waste. The treated waste is removed at the bottom of the vessel.

Example 3: an integrated steam-based system combines internal shredding, steam treatment–mixing and drying in a semicontinuous unit. Waste is loaded into the hopper, where a negative pressure is maintained by drawing air

through a HEPA filter. The waste in the hopper drops into a heavy-duty shredding unit, where downward pressure is applied using a ram. The heavy-duty shredder reduces waste volume up to 90%. Shredded material enters an inclined rotating auger (screw), where steam is introduced through multiple ports by raising the temperature in the conveyor from 96 °C to 118 °C. The steam is discharged through a vent at the very end of the conveyor and through a condenser to dry the waste. The decontaminated waste exits the conveyor into a self-contained compactor or roll-off container for transport to final disposal.

These and other integrated steam treatment technologies have the advantages of being able to achieve high levels of disinfection at shorter times through improved rates of heat transfer. They are highly automated and computer controlled, and require very little operator attention. Treatment parameters are automatically recorded, providing the required documentation. Many are designed to remove odours using activated carbon or HEPA filters. Since they involve internal or post-treatment shredding and many have a drying cycle, the resulting waste is not only unrecognizable but also dry and compact, corresponding to as much as 85–90% volume reduction. Unlike standard autoclaves, some of these integrated systems – for example, the rotating autoclave – have been tested successfully for use with animal waste and could potentially be used with pathological waste, including anatomical parts. The biggest disadvantage with the more sophisticated steam treatment systems is the capital cost: steam treatment systems cost more than standard autoclave designs with the same capacity.

8.5 Microwave treatment technologies

Microwave technology is essentially a steam-based process where treatment occurs through the action of moist heat and steam generated by microwave energy. Water contained in the waste is rapidly heated by microwave energy at a frequency of about 2450 MHz and a wavelength of 12.24 cm. In general, microwave-treatment systems consist of a treatment area or chamber into which microwave energy is directed from a microwave generator (magnetron). Generally, 2 to 6 magnetrons are used with an output of about 1.2 kW each. Some systems are designed as batch processes and others are semicontinuous (Emmanuel, 2001; Emmanuel & Stringer, 2007).

Typical batch systems are designed to handle 30 to 100 litres of waste. Some units require reusable, fully enclosed, microwavable containers. The systems may have multiple programmable cycles corresponding to different treatment temperatures or levels of disinfection. A cycle may range from 30 minutes to one hour.

A typical semicontinuous microwave system consists of an automatic charging system, hopper, shredder, conveyor screw, steam generator, microwave generators, discharge screw, secondary shredder and controls. The equipment includes hydraulics, HEPA filter and microprocessor-based controls protected in an all-weather steel enclosure. Waste bags are introduced into the hopper, where steam may also be injected. To prevent release of airborne pathogens, air is extracted through a HEPA filter as the waste bags are loaded. After the hopper lid is closed, waste goes through a shredder. The waste particles are conveyed through an auger (conveyor screw), where they are further exposed to steam and heated to 100 °C by four or six microwave generators. Some systems have a holding section to achieve a minimum exposure time. A secondary shredder may be used if treated sharps require finer shredding. A large-scale, semicontinuous microwave unit is capable of treating about 250 kg/hour (3000 tonnes per year).

The types of waste commonly treated in microwave systems are identical to those treated in autoclaves: cultures and stocks, sharps, materials contaminated with blood and body fluids, isolation and surgery waste, laboratory waste (excluding chemical waste) and soft waste (e.g. gauze, bandages, gowns and bedding) from patient care. One microwave system has been successfully tested with animal waste and can potentially be used to treat pathological waste such as tissues (Devine et al., 2007). Volatile and semivolatile organic compounds, chemotherapeutic waste, mercury, other hazardous chemical waste and radiological waste should not be treated in a microwave.

A fully enclosed microwave unit can be installed in an open area and, with a HEPA filter to prevent the release of aerosols during the feed process, odour is somewhat reduced, except in the immediate vicinity of the microwave unit.

Figure 8.2 shows a simple schematic of a batch and semicontinuous microwave system.

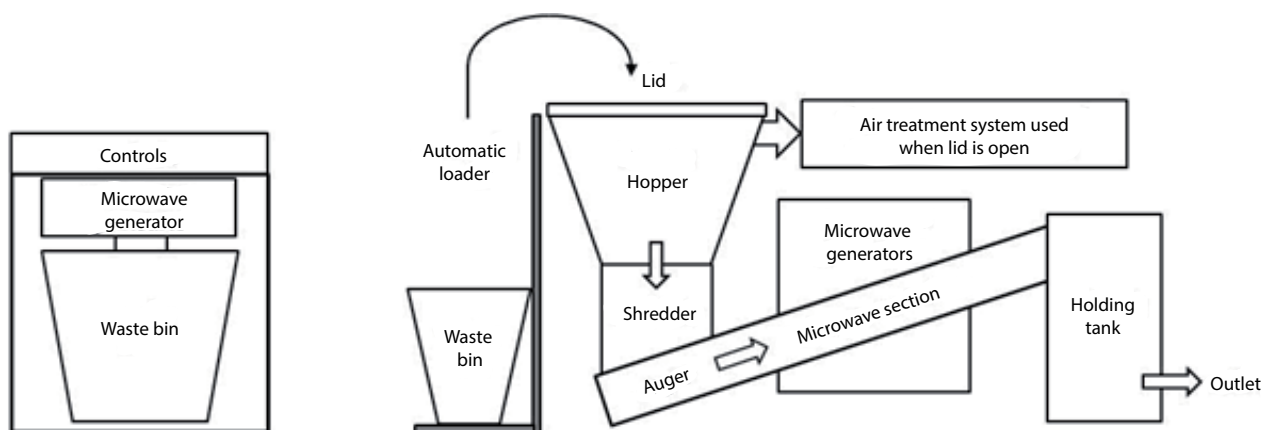

Source: Jorge Emmanuel

Figure 8.2 Simplified schematic of batch and semicontinuous microwave technologies

8.6 Dry-heat treatment technologies

Circulating hot-air ovens have been used to sterilize glassware and other reusable instruments for many years. This concept of dry-heat treatment has been applied to treatment of infectious health waste more recently. In dry-heat processes, heat is applied without adding steam or water. Instead, the waste is heated by conduction, natural or forced convection, or thermal radiation. In forced convection heating, air heated by resistance heaters or natural gas is circulated around the waste in the chamber. In some technologies, the hot walls of the chamber heat the waste through conduction and natural convection. Other technologies use radiant heating by means of infrared or quartz heaters. As a general observation, dry-heat processes use higher temperatures and longer exposure times than steam-based processes. They are not commonly used in large-scale facilities and usually treat only small volumes. *Bacillus atrophaeus* spores are known to be resistant to dry heat and are commonly used as a microbiological indicator to measure the effectiveness of dry-heat technologies (Emmanuel, 2001; Emmanuel & Stringer, 2007).

8.7 Chemical treatment technologies

Chemical disinfection, used routinely in health-care facilities to destroy or inactivate microorganisms on medical equipment and on floors and walls, is now being extended to the treatment of health-care waste. This treatment usually results in disinfection rather than sterilization. Chemical disinfection is most suitable for treating liquid waste such as blood, urine, stools or hospital sewage. Solid, even highly hazardous, health-care wastes, including microbiological cultures and sharps, may also be disinfected chemically, with the following limitations:

- Shredding or milling of waste is usually necessary before disinfection. The shredder is often the weak point in the treatment chain, being susceptible to mechanical failure or breakdown.
- Powerful disinfectants are required, which can be hazardous and should be used only by well-trained and adequately protected personnel.
- Disinfection efficiency depends on the operational conditions within treatment equipment.
- Only the surface of intact solid waste items will be disinfected.

Chemical treatment of solid infectious waste is potentially problematic because of the variability of chemical efficacy based upon load characteristics, and the generation of toxic liquid waste. The speed and efficiency of chemical disinfection will depend on operational conditions, including:

- the kind of chemical used
- the amount of chemical used
- the contact time between disinfectant and waste
- the extent of contact between disinfectant and waste
- the organic load of the waste
- operating temperature, humidity, pH.

Manual systems using chemical disinfection are not regarded as a reliable method for treating waste. Chemical disinfection is usually carried out on hospital premises; however, commercial, self-contained and fully automatic systems have recently been developed for health-care waste treatment and are being operated away from medical centres at industrial zones. Subsequently, the disinfected waste requires specialized disposal.

8.7.1 Internal shredding of waste

Shredding of solid health-care waste before or during disinfection should be done in a closed system to avoid release of pathogens into the air. Rotating-blade shredders are used most commonly and consist of blades attached to two wheels that rotate in opposite directions. The presence of an excessive proportion of sharps in waste may cause accelerated deterioration of the shredder. Internal shredding is essential for the following reasons:

- to increase the surface area of contact between waste and disinfectant, eliminating voids in the waste load
- to render any anatomical parts unrecognizable to avoid adverse visual impact on disposal
- to reduce the volume of waste.

Water is usually added during shredding to prevent excessive wearing of the mechanical parts and facilitate subsequent contact with the disinfectant. Excess water draining from the waste may have to be treated (e.g. by chemical disinfection). Internal shredding of waste before disinfection plus subsequent compacting can reduce the original waste volume by 60–90%, depending on the type of equipment used.

8.7.2 Chemical disinfectants

The aim of disinfection is to eliminate microorganisms or at least reduce their numbers to an acceptable level. Some disinfectants are effective in killing or inactivating specific types of microorganisms, and others are effective against all types. It is therefore important to know the identity of the target microorganisms to be destroyed. However, selection of disinfectants depends not only on their effectiveness, but also on their availability and hazards related to their handling.

The types of chemicals used for disinfection of health-care waste are mostly chlorine compounds, aldehydes, lime-based powders or solutions, ozone gas, ammonium salts and phenolic compounds. The characteristics of the most commonly used chemical disinfectant for waste applications are outlined in Box 8.1. Formaldehyde and ethylene oxide are no longer recommended for waste treatment due to significant hazards related to their use.

Box 8.1 Characteristics of sodium hypochlorite (NaOCl) as a chemical disinfectant

Application

Active against most bacteria, viruses and spores; not effective for disinfection of liquids with high organic content, such as blood or stools; widely used for treatment of wastewater. For waste, operating parameters should be adjusted on the basis of bacteriological tests.

Physical and chemical properties

Available as aqueous solution with 2–12% of active chlorine; at ambient temperature, slowly decomposes into sodium chlorate, sodium chloride and oxygen; solutions of low concentration are more stable; solutions should be protected from light, which accelerates decomposition; reacts with acids to produce hazardous chlorine gas.

Health hazards

Irritant to skin, eyes and respiratory tract; toxic.

Protective measures

Gloves and protective eye glasses should be worn during handling of sodium hypochlorite to protect skin and eyes; in case of eye contact, the eyes should be rinsed abundantly with water.

Corrosiveness

Aqueous solutions are corrosive to metals; usually stored in plastic containers in well-ventilated, dark and leakage-proof rooms; should be stored separately from acids.

Comments

Sodium hypochlorite may be widely used because of relatively mild health hazards. Unused solutions should be reduced with sodium bisulfite or sodium thiosulfate and neutralized with acids before discharge into sewers. Large quantities of concentrated solutions should be treated as hazardous chemical waste.

Sodium hypochlorite is a commonly used disinfectant in health-care facilities and often referred to as “hypochlorite”. It is readily available and effective in inactivating bacteria, fungi and viruses, as well as controlling odour. However, the biocidal activity of hypochlorite is diminished by a high organic content in liquid waste, such as blood. It is an irritant of the respiratory tract, skin and eyes, and should be handled carefully. Hypochlorite can react with organic compounds in the wastewater to form toxic by-products. Chlorine dioxide is an alternative to hypochlorite. It is a toxic gas that is readily soluble and stable in water and can be generated onsite at a health-care facility.

Lime-based chemical treatment systems use dry powder or calcium hydroxide solutions. Some chemical treatment systems use proprietary disinfectants containing glutaraldehyde. Peracetic acid (peroxyacetic acid) has also been used for disinfecting medical instruments. It is a strong irritant but breaks down to form an acetic acid (vinegar) solution.

Users of chemical disinfectants should take into account their stability and shelf life. Some disinfectants are stable for several years and can remain effective for months after opening the container. Other disinfectants degrade quickly.

Powerful disinfectants are often hazardous and toxic, and many are harmful to skin and mucous membranes. Users should therefore be aware of their physiological effects and wear protective clothes, including gloves and protective eye glasses or goggles. Disinfectants are also aggressive to certain building materials and should be handled and stored according to manufacturers' instructions.

8.7.3 Microbial resistance

Microbial resistance to disinfectants has been investigated, and it is possible to list the major groups of microorganisms from most to least resistant as follows:

- bacterial spores
- mycobacteria
- hydrophilic viruses
- lipophilic viruses

- vegetative fungi and fungal spores
- vegetative bacteria.

A disinfectant known to be effective against a particular group of microorganisms will also be effective against all the groups that are less resistant. Most parasites, such as *Giardia* and *Cryptosporidium* spp., are significantly resistant to disinfection and are usually rated between mycobacteria and viruses. The effectiveness of disinfection is estimated from the survival rates of indicator organisms in standard microbiological tests.

8.7.4 Alkaline hydrolysis

Alkaline hydrolysis or alkaline digestion is a process that converts animal carcasses, human body parts and tissues into a decontaminated aqueous solution. The alkali also destroys fixatives in tissues and various hazardous chemicals, including formaldehyde, glutaraldehyde and chemotherapeutic agents. The technology uses a steam-jacketed, stainless-steel tank and a basket. After the waste is loaded in the basket and into the hermetically sealed tank, alkali (sodium or potassium hydroxide) in amounts proportional to the quantity of tissue in the tank is added, along with water. The contents are heated to between 110 °C and 127 °C or higher, and stirred. Depending on the amount of alkali and temperature used, digestion times range from six to eight hours.

The technology is designed for tissue wastes including anatomical parts, organs, placenta, blood, body fluids, specimens, human cadavers and animal carcasses. The process has been shown to destroy prion waste. The by-products of the alkaline digestion process are biodegradable mineral constituents of bones and teeth (which can be crushed and recovered as sterile bone meal) and an aqueous solution of peptide chains, amino acids, sugars, soaps and salts. An excess of hydroxide could lead to a high pH of the liquid waste. Alkaline hydrolysis units have been designed to treat from 10 kg to 4500 kg per batch. The technology has been approved for the destruction of prion waste when treated for at least six hours (European Commission Scientific Steering Committee, 2003; Thacker, 2004).

8.8 Incineration

8.8.1 Combustion

Incineration is a high-temperature, dry oxidation process that reduces organic and combustible waste to inorganic, incombustible matter and results in a significant reduction of waste volume and weight. High-heat thermal processes take place at temperatures from about 200 °C to more than 1000 °C. They involve the chemical and physical breakdown of organic material through the processes of combustion, pyrolysis or gasification. A disadvantage of these technologies is the release of combustion by-products into the atmosphere and the generation of residual ash. The combustion of health-care waste produces mainly gaseous emissions, including steam, carbon dioxide, nitrogen oxides, a range of volatile substances (e.g. metals, halogenic acids, products of incomplete combustion) and particulate matter, plus solid residues in the form of ashes. Figure 8.3 shows a simple schematic of the incineration process.

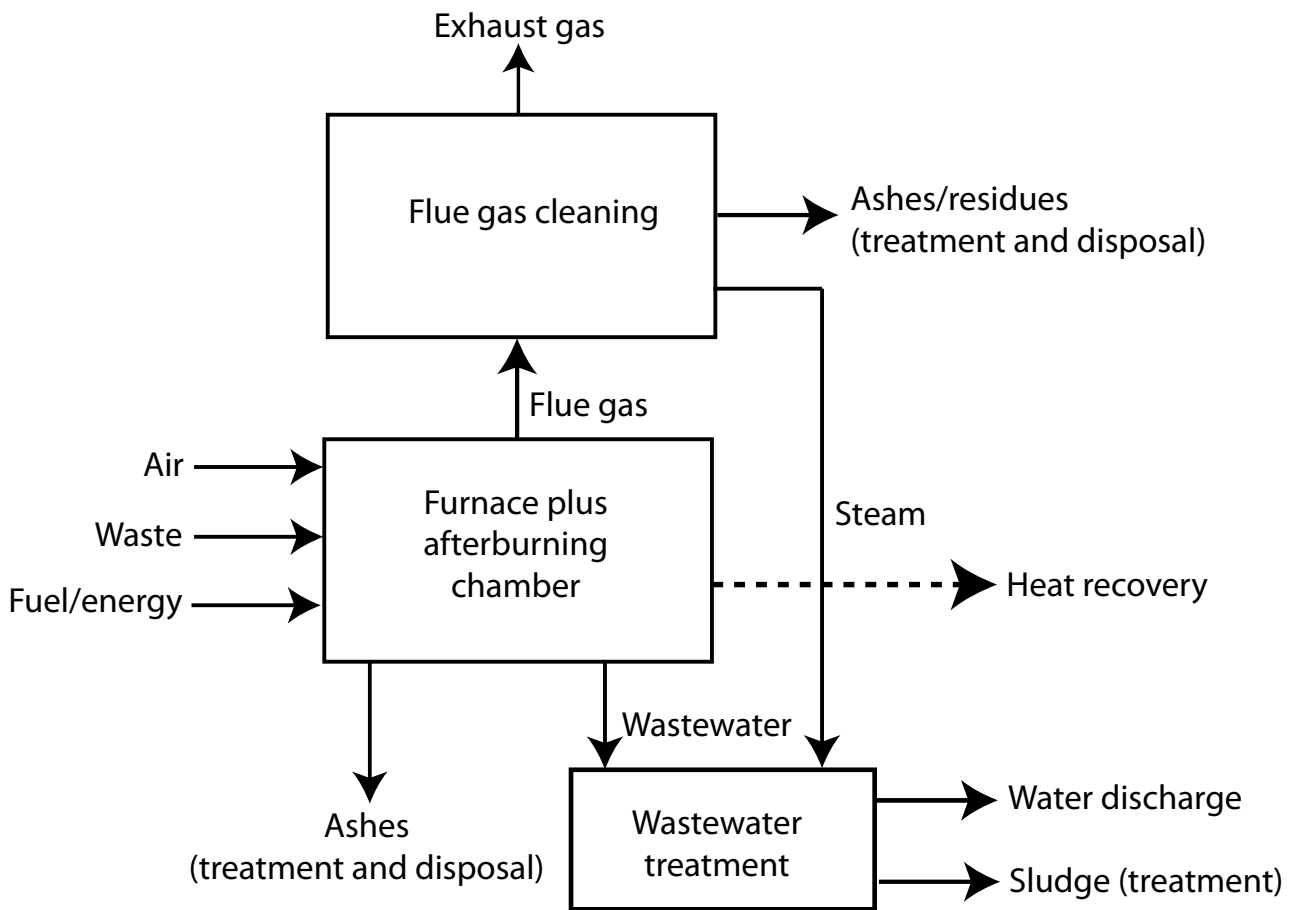

Source: Adapted by Jorge Emmanuel from UNEP (2006)

Figure 8.3 Simplified flow scheme of the incineration process

The Stockholm Convention guidance on best available techniques and best environmental practices states: “If medical waste is incinerated in conditions that do not constitute best available techniques or best environmental practices, there is potential for the release of PCDD [polychlorinated dibenzodioxins] and PCDF [polychlorinated dibenzofurans] in relatively high concentrations” (Secretariat of the Stockholm Convention, 2006).

The World Health Organization (WHO) has reviewed small-scale health-care incinerators and reported “significant problems regarding the siting, operation, maintenance and management of [these] incinerators” (Batterman, 2004). As a result of these and other concerns, together with the very high costs for modern incineration to meet best available technique (BAT) standards, the WHO report concluded that “small-scale incineration is viewed as a transitional means of disposal for health care waste” (Batterman, 2004).

8.8.2 Pyrolysis and gasification

Pyrolysis and gasification processes operate with substoichiometric air levels. The difference between pyrolysis, gasification and incineration is clarified in Table 8.1.

Table 8.1 Typical reaction conditions and products from pyrolysis, gasification and incineration processes

	Pyrolysis	Gasification	Incineration
Reaction temperature (°C)	250–700	500–1600	800–1450
Pressure (bar)	1	1–45	1
Atmosphere	Inert/nitrogen	Gasification agent: O ₂ , H ₂ O	Air
Stoichiometric ratio	0	<1	>1
Products from the process:			
Gas phase	H ₂ , CO, C _x H _y , H ₂ O, N ₂	H ₂ , CO, CO ₂ , CH ₄	CO ₂ , H ₂ O, O ₂
Solid phase	Ash, coke	H ₂ O, N ₂	NO ₂
Liquid phase	Pyrolysis oil, water	Slag, ash	Slag, ash

Source: BREF (2006)

8.8.3 Required waste characteristics

Incineration of waste is affordable and feasible only if the “heating” (or “calorific”) value of the waste reaches at least 2000 kcal/kg (8370 kJ/kg). While the value for hospital wastes containing high levels of plastics can exceed 4000 kcal/kg (16 740 kJ/kg), some health-care waste may contain a high proportion of wet waste and have much lower calorific values. The basic characteristics necessary for incineration include:

- heating value above 2000 kcal/kg (8370 kJ/kg);
- calorific values within the regulatory and design requirements (e.g. the desired residence time, system operating temperature and excess air levels);
- content of combustible matter above 60%;
- content of non-combustible solids below 5%;
- content of non-combustible fines below 20%;
- moisture content below 30%.

Incineration requires no pretreatment, provided the following waste types are not included or are kept to an absolute minimum:

- pressurized gas containers;
- large amounts of reactive chemical waste;
- silver salts and photographic or radiographic wastes;
- halogenated materials such as polyvinyl chloride (PVC) plastics (waste and packaging of waste should not contain PVC material);
- waste containing mercury, cadmium and other heavy metals, such as broken thermometers, used batteries and lead-lined wooden panels;
- sealed ampoules or vials that may implode during the combustion process;
- radioactive materials;
- pharmaceuticals thermally stable in conditions below 1200 °C (e.g. 5-fluorouracil).

8.8.4 Energy recovery

Many modern large incineration facilities can reuse the heat generated from the combustion of waste, so energy recovery seems an attractive proposition. However, there are characteristics that need to be taken into consideration. Most health-care waste incinerators are too small for energy recovery to be effective. Whenever energy recovery is

being considered, it requires specialized advice on whether the proposition is technically and financially feasible for the local circumstances.

8.8.5 Types of incinerators for health-care waste

Incinerators range from extremely sophisticated, high-temperature operating plants to very basic combustion units. All types of incinerators, if operated properly, should eliminate pathogens from waste and reduce waste to a small volume of ash. Incineration equipment should be chosen on the basis of the available resources and the local situation, balancing the public health benefits of pathogen elimination against the technical requirements needed to avoid the health impacts of air or groundwater pollution from the by-products of waste combustion.

Three generic kinds of incineration technology are commonly used for treating health-care waste:

- dual-chamber starved-air incinerators, which operate in the starved-air mode (below stoichiometric conditions) in the primary chamber and are designed to burn infectious health-care waste;
- multiple chamber incinerators, including in-line incinerators and retort incinerators used for pathological waste, which operate in the excess-air mode (above stoichiometric conditions);
- rotary kilns, normally capable of reaching temperatures that break down genotoxic substances and heat-resistant chemicals.

Starved-air incinerators

Starved-air incineration is a commonly used incineration process for health-care waste. The process is also known as controlled-air incineration, pyrolytic incineration, two-stage incineration or static hearth incineration. The combustion air used for incineration is less than stoichiometric (that is, the amount of oxygen is less than the ideal proportion needed for burning the carbon and hydrogen).

A starved-air incinerator comprises a primary chamber and a post-combustion secondary chamber. In the primary chamber, the waste is thermally decomposed through an oxygen-deficient, medium-temperature combustion process (800 to 900 °C), producing solid ashes and gases. The primary chamber includes a fuel burner, used to start the process. Waste residence time can vary from 1 to 4 hours, depending on the size of the installation. The gases produced in the primary chamber are burned at high temperature (ranging from 1100 to 1600 °C) in the secondary chamber, using an excess of air to minimize smoke, carbon monoxide and odours. If the temperature drops below 1100 °C (the minimum requirement specified in the European Union's *Waste incineration directive 2000/76/EC*), additional energy should be provided by a gas or fuel burner.

Larger pyrolytic incinerators (capacity >20 tonnes/day) are usually designed to function on a continuous basis. They are also capable of automatic operation, including loading of waste, removal of ashes and internal movement of burning waste.

Multiple chamber incinerators

Multiple chamber incinerators were more common in the past and are still used in some countries for pathological waste. There are two major types: in-line incinerators and retort incinerators. In-line incinerators are rectangular in design and have a large primary chamber with a moving grate, a secondary chamber to burn off volatile organic compounds in the flue gas, and additional chambers that force the gas to turn in different directions to remove particulate matter as ash residues.

Retort incinerators have a primary and a secondary chamber arranged in a "U" shape. Flue gas from the primary chamber (hearth) is generally passed under the primary chamber to add heat to the hearth. Both types of incinerators operate in the excess-air mode and use supplementary fuel to reach temperatures of around 800–1000 °C. These designs are not commonly used because of their high volumes of airborne emissions.

Rotary kilns

A rotary kiln has a rotating oven and a post-combustion chamber (see Figure 8.4). They can be specifically designed to burn chemical wastes and may also be suitable as a large-scale regional health-care waste incinerator if appropriate temperatures and scrubbing (flue gas cleaning) equipment are used. The main characteristics of rotary kilns are:

- incineration temperatures between 900 and 1200 °C are possible;
- incinerator capacities up to 10 tonnes per hour are available;
- additional equipment and operation costs are high, as is energy consumption; the system also requires well-trained personnel.

The axis of a rotary kiln is inclined at a slight angle to the horizontal (3–5% slope). The kiln rotates 2–5 times per minute and is charged with waste at its upper end. Ashes are subsequently discharged at the bottom end. The gases produced in the kiln are heated to high temperatures to burn off gaseous organic compounds in the post-combustion chamber, and typically have a long residence time of two or more seconds.

Rotary kilns may operate continuously and are adaptable to a wide range of loading devices. Those designed to treat toxic wastes should preferably be operated by specialist waste-disposal agencies and located away from health-care facilities in industrial areas.

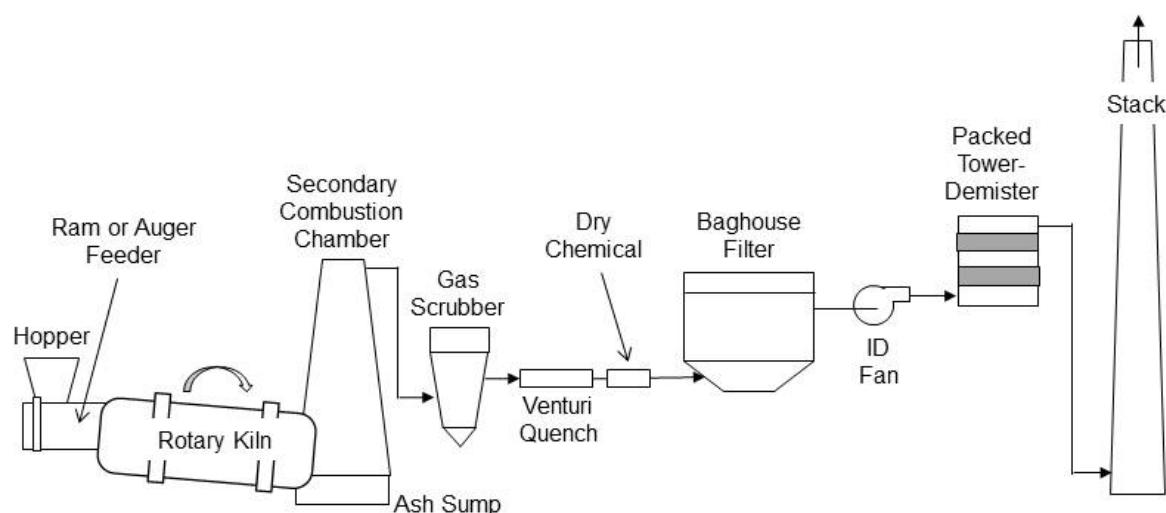

Source: Jorge Emmanuel

Figure 8.4 Simplified schematic of a rotary kiln incinerator

Small-scale incinerators

Small-scale incinerators are designed to meet an immediate need for public health protection where there is no access to more sophisticated technologies. This involves a compromise between the environmental impacts from controlled combustion and an overriding need to protect public health if the only alternative is indiscriminate dumping. These circumstances exist in many developing situations, and small-scale incineration can be a realistic response to an immediate requirement (Batterman, 2004). As far as possible, a small-scale facility should avoid burning PVC plastics and other chlorinated waste.

If small-scale incinerators are the only option available, the best practices possible should be used, to minimize operational impacts on the environment. Best practices in this context are (Batterman, 2004):

- effective waste reduction and segregation, ensuring only the smallest quantities of combustible waste types are incinerated;
- an engineered design with sufficient residence time and temperatures to minimize products of incomplete combustion;
- siting incinerators away from health-care buildings and residential areas or where food is grown;
- construction using detailed engineering plans and materials to minimize flaws that may lead to incomplete destruction of waste and premature failures of the incinerator;
- a clearly described method of operation to achieve the desired combustion conditions and emissions; for example, appropriate start-up and cool-down procedures, achievement and maintenance of a minimum temperature before waste is burned, use of appropriate loading/charging rates (both fuel and waste) to maintain appropriate temperatures, proper disposal of ash and equipment to safeguard workers;
- periodic maintenance to replace or repair defective components (including inspection, spare parts inventory and daily record keeping);
- improved training and management, possibly promoted by certification and inspection programmes for operators, the availability of an operating and maintenance manual, visible management oversight, and regular maintenance schedules.

In 2004, WHO commissioned a screening-level health risk assessment for exposure to dioxins and furans from small-scale incinerators. The study found that the expected practice with small-scale incinerators resulted in unacceptable cancer risks under medium usage (two hours per week) or higher (Batterman, 2004). The report concluded that small-scale incineration should be viewed as a transitional means of disposal for health-care waste. Single-chamber, drum and brick incinerators do not meet the BAT requirements of the Stockholm Convention guidelines (Secretariat of the Stockholm Convention, 2006).

Co-incineration

High-temperature incineration of chemical and pharmaceutical waste in industrial cement kilns or steel furnaces is practised in some countries. Significant additional investments can be required to modify the facilities for safe handling and loading of medical wastes, and the machines are rarely equipped with filtration and clean-up equipment suitable for the pollutants generated. The Stockholm Convention guidelines list infectious medical wastes on a negative list of wastes not recommended for co-processing (Secretariat of the Stockholm Convention, 2006).

In some countries, it is permitted to incinerate health-care waste in a municipal solid waste incineration plant. The heating value of health-care waste can be higher than that of domestic refuse, and the introduction of relatively small quantities of health-care waste should not affect significantly the operation of municipal incinerators. Care must be taken with the handling and loading of the health-care wastes to avoid hazardous situations. Municipal incinerators are usually designed with an operating temperature of >850 °C.

8.8.6 Environmental control of incinerators

General principles

Incinerator emissions should comply with national standards and in accordance with the Stockholm Convention BAT and best environmental practices (BEP) guidance in those countries that have signed the convention. If the relevant authorities have not established such regulations, the BAT/BEP guidelines or international standards are examples of those that could be followed (Table 8.2).

Table 8.2 Emission guidelines for health-care waste incinerators

Pollutant	Unit	Standard conditions ^a	US EPA emission limits			EU emission limits			AP 42 ^f
			Small ^b	Medium ^b	Large ^b	Daily ave.	Half-hour ave. ^c	0.5–8-hour ave.	
Particulate matter or total dust	mg/m ³	20 °C, 101.3 kPa, 7% O ₂ , dry	66	22	18				223
		273 °K, 101.3 kPa, 11% O ₂ , dry				10	10, 30		
Carbon monoxide	ppm(v)	20 °C, 101.3 kPa, 7% O ₂ , dry	20	1.8	11				127
	mg/m ³	273 °K, 101.3 kPa, 11% O ₂ , dry				50	100 ^d		
Dioxins/furans	ng TEQ /m ³	20 °C, 101.3 kPa, 7% O ₂ , dry	0.013	0.014	0.035				4.1
	ng TEQ /m ³	273 °K, 101.3 kPa, 11% O ₂ , dry						0.1 ^e	
Gaseous and vaporous organics as total organic carbon	mg/m ³	273 °K, 101.3 kPa, 11% O ₂ , dry				10	10, 20		15
Hydrogen chloride	ppm(v)	20 °C, 101.3 kPa, 7% O ₂ , dry	15	7.7	5.1				1106
	mg/m ³	273 °K, 101.3 kPa, 11% O ₂ , dry				10	10, 60		
Hydrogen fluoride	mg/m ³	273 °K, 101.3 kPa, 11% O ₂ , dry				1	2, 4		
Sulfur dioxide	ppm(v)	20 °C, 101.3 kPa, 7% O ₂ , dry	1.4	1.4	8.1				54.6
	mg/m ³	273 °K, 101.3 kPa, 11% O ₂ , dry				50	50, 200		
Nitrogen oxides	ppm(v)	20 °C, 101.3 kPa, 7% O ₂ , dry	67	67	140				93
	mg/m ³	273 °K, 101.3 kPa, 11% O ₂ , dry				200	200, 400		

Table 8.2 *continued*

Pollutant	Unit	Standard conditions ^a	US EPA emission limits			EU emission limits			AP 42 ^f
			Small ^b	Medium ^b	Large ^b	Daily ave.	Half-hour ave. ^c	0.5–8-hour ave.	
Cadmium	mg/m ³	20 °C, 101.3 kPa, 7% O ₂ , dry	0.017	0.0098	0.00013				0.3
Cadmium and thallium	mg/m ³	273 °K, 101.3 kPa, 11% O ₂ , dry						total 0.05	
Mercury	mg/m ³	20 °C, 101.3 kPa, 7% O ₂ , dry	0.014	0.0035	0.0013				5.4
	mg/m ³	273 °K, 101.3 kPa, 11% O ₂ , dry						0.05	
Lead	mg/m ³	20 °C, 101.3 kPa, 7% O ₂ , dry	0.31	0.018	0.00069				3.6
Antimony, arsenic, lead, chromium, cobalt, copper, manganese, nickel, vanadium and their compounds	mg/m ³	273 °K, 101.3 kPa, 11% O ₂ , dry						total 0.5	

AP 42, air pollution emission factor 42; ave., average; EU, European Union; TEQ, toxic equivalent; US EPA, United States Environmental Protection Agency

Different standard conditions are defined for EPA and EU limits; corrections have to be made to convert between different standard temperatures and percentage oxygen.

EPA defines small incinerators as having a waste burning capacity ≤200 lbs/h, medium capacity as >200–500 lbs/h and large capacity as >500 lbs/h.

At least 97% of half-hourly average concentrations must meet the first value and 100% must meet the second value.

All half-hourly average concentrations taken in any 24-hour period must meet this value.

The sampling period for dioxins/furans must be a minimum of 6 hours and a maximum of 8 hours under the EU directive.

AP 42 (EPA, 1996) are emission estimates for incinerators without air pollution equipment and are shown for comparison; adapted from Batterman (2004).

Sources: EPA (2011); European Parliament and the Council of the European Union (2000)

Incinerators require emission controls equipment to meet modern emission standards. Ferraz & Afonso (2003) determined that without emission controls dioxin concentrations in combustion gases were 93 to 710 times higher than the European Union legal limit (0.1 ng TEQ/m³), depending on variations in the waste composition.

Flue (exhaust) gases from incinerators contain fly ash (particulates), heavy metals, dioxins, furans, thermally resistant organic compounds, and gases such as oxides of nitrogen, sulfur, carbon and hydrogen halides. The flue gases should be treated, and this should be done in at least two different stages:

- “de-dusting” to remove most of the fly ash
- washing with alkaline substances to remove hydrogen halides and sulfur oxides.

Flue gas treatment can be performed by wet, dry or semidry treatment, or a combination of these processes. The temperature of the combustion process has to be very closely controlled to avoid generating furans and dioxins, and the temperature in the flue gases should be cooled down rapidly to prevent dioxins and furans from reforming.

Stockholm Convention

The Stockholm Convention is a legally binding treaty with the goal of protecting human health and the environment from persistent organic pollutants. Under the convention, the countries party to the treaty are required to use the best available techniques for new incinerators. The Stockholm Convention's guidelines for best available techniques and best environmental practices limit the levels of dioxins and furans in air emissions to 0.1 ng I-TEQ/Nm³ at 11% O₂. Moreover, dioxins in the wastewater of treatment plants treating effluents from any gas treatment scrubber effluents should be well below 0.1 ng I-TEQ per litre. In addition, the guidelines list primary and secondary measures to achieve the performance levels for removal of dioxins and furans. The primary measures are to:

- introduce the waste into the combustion chamber only at temperatures of ≥ 850 °C;
- install auxiliary burners for start-up and shut-down operations;
- avoid regular starting and stopping of the incineration process;
- avoid combustion temperatures below 850 °C and cold regions in the flue gas;
- control oxygen input depending on the heating value and consistency of feed material;
- maintain minimum residence time of two seconds above 850 °C in the secondary chamber after the last injection of air or at 1100 °C for wastes containing more than 1% halogenated organic substances (generally the case for health-care waste) and 6% O₂ by volume;
- maintain high turbulence of exhaust gases and reduction of excess air by injection of secondary air or recirculated flue gas, preheating of the air-streams or regulated air inflow;
- conduct on-line monitoring for combustion control (temperature, oxygen content, carbon monoxide, dust), and operation and regulation of the incinerator from a central console.

The secondary measures to further reduce dioxins and furans are an appropriate combination of dust-removal equipment and other techniques, such as catalytic oxidation, gas quenching and wet or (semi) dry adsorption systems. Furthermore, fly and bottom ash, as well as wastewater, should be treated appropriately. Carbon monoxide, oxygen in the flue gas, particulate matter, hydrogen chloride, sulfur dioxide, nitrogen oxides, hydrogen fluoride, airflows and temperatures, pressure drops and pH in the flue gas should be routinely monitored according to national laws and manufacturers' guidance.

8.8.7 Dust removal

The design of flue gas cleaning facilities assumes normal operation of an incinerator, especially temperature and air inputs. Depending on the type of incinerator, it is likely to produce between 25 and 30 kg of dust per tonne of waste (known as fly ash). For example, an incinerator of 20 tonnes/day capacity would need to be equipped with dust

removal equipment to handle at least 600 kg/day (30 kg/tonne × 20 tonnes) of dust. The most common types of dust removal equipment used at incinerator plants are:

- cyclonic scrubbers
- fabric dust removers (commonly called “baghouse filters”)
- electrostatic precipitators.

Flue gas emerges from the post-combustion chamber at about 800–1000 °C and must be cooled to 200–300 °C before entering the dust-removal equipment. This can be achieved in cooling towers, called quenching towers or baths, where the gas is cooled by water circulating in a closed system. (The water may subsequently be used for preheating waste or for other purposes.) A common method is the use of a boiler in which heat exchange takes place between the hot flue gas stream and boiler water. The hot flue gas stream is cooled, and boiler water is heated (the energy of this heated water or steam can be used for generating electricity or for other purposes). The flue gas can also be cooled by introducing fresh air, although this method is less efficient.

Removal of acids or alkalis

Three processes – wet, semi-dry and dry – are available for removing acids such as hydrofluoric acid (HF), hydrochloric acid (HCl), and sulfuric acid (H₂SO₄). In the wet process, gases are washed in a spraying tower with soda or lime solution, which also contributes to gas cooling and to the removal of very small particulates. In the semi-dry process (also known as semi-wet process), a lime suspension is injected into the gas column. Salts generated by the neutralization process have to be removed. In the dry process, lime powder is injected into the gas column, and the salts produced during the neutralization have to be removed. The wet process is the most efficient of these three options, but requires complex treatment of the resultant wastewater.

Wastewater from gas washing and quenching of ashes must undergo a chemical neutralization treatment before being discharged into a sewer. This treatment includes neutralization of acids and flocculation, and precipitation of insoluble salts.

Solid residues

Sludges from wastewater treatment and from cooling of fly ash should be considered as hazardous waste. They may either be sent to a waste-disposal facility for hazardous chemicals, or be treated onsite by drying, followed by encapsulation. Solid ashes from health-care waste incineration (known as bottom ash) are often assumed to be less hazardous than fly ash and in the past have been reused in civil engineering works. Recently, growing debate about potential leakage of toxic substances from these ashes and possible pollution of groundwater has led some countries to require these ashes to be disposed of in landfills designed specifically for hazardous substances.

The United Nations Environment Programme tested two hospital waste incinerators that had been built in the mid-1990s and reported that “the bottom ashes [from a hospital waste incinerator] were between 1,410 and 2,300 ng I-TEQ/kg” (UNEP, 2001). The extremely high concentrations in the bottom ashes reflect the inefficient combustion in the furnace and the synthesis of polychlorinated dibenzodioxins or polychlorinated dibenzofurans overnight.

8.9 Encapsulation and inertization

Disposal of untreated health-care waste in municipal landfills is not advisable. However, if the health-care facility has no other option, the waste should be contained in some way before disposal. One option is encapsulation, which involves filling containers with waste, adding an immobilizing material, and sealing

the containers. The process uses either cubic boxes made of high-density polyethylene or metallic drums, which are three quarters filled with sharps or chemical or pharmaceutical residues. The containers or boxes are then filled up with a medium such as plastic foam, bituminous sand, cement mortar, or clay material. After the medium has dried, the containers are sealed and placed into landfill sites.

This process, where the encapsulation materials are available, is appropriate for establishments for the disposal of sharps and chemical or pharmaceutical residues. Encapsulation alone is not recommended for non-sharps waste, but may be used in combination with treatment of such waste. The main advantage of the process is its effectiveness in reducing the risk of scavengers gaining access to the hazardous health-care waste.

The process of inertization involves mixing waste with cement and other substances before disposal to minimize the risk of toxic substances contained in the waste migrating into surface water or groundwater. It is especially suitable for pharmaceuticals and for incineration ashes with a high metal content (in this case, the process is also called “stabilization”).

For the inertization of pharmaceutical waste, the packaging should be removed, the pharmaceuticals ground, and a mixture of water, lime and cement added. A homogeneous mass is formed, and cubes (e.g. of 1 m³) or pellets are produced onsite. Subsequently, these can be transported to a suitable storage site. Alternatively, the homogeneous mixture can be transported in liquid state to a landfill and poured onto the surface of previously landfilled municipal waste, then covered with fresh municipal waste.

The following are typical proportions (by weight) for the mixture:

- 65% pharmaceutical waste
- 15% lime
- 15% cement
- 5% water.

The process is reasonably inexpensive and can be performed using relatively unsophisticated mixing equipment. Other than personnel, the main requirements are a grinder or road roller to crush the pharmaceuticals, a concrete mixer and supplies of cement, lime and water.

8.10 Emerging technologies

Developing and emerging technologies should be carefully evaluated before their selection for routine use, because most do not have a demonstrable track record in health-care waste applications. Technologies most commonly discussed in the literature are plasma pyrolysis, superheated steam, ozone and promession.

Plasma pyrolysis makes use of an ionized gas in the plasma state to convert electrical energy to temperatures of several thousand degrees using plasma arc torches or electrodes. The high temperatures are used to pyrolyse waste in an atmosphere with little or no air. Another emerging technology uses superheated steam at 500 °C to break down infectious, hazardous chemical or pharmaceutical wastes. The vapours are then heated further in a steam-reforming chamber to 1500 °C. These technologies are expensive, and – like incineration – require pollution-control devices to remove pollutants from the exhaust gas.

Ozone (O₃) can be used for disinfecting waste. Ozone gas is a strong oxidizer and breaks down easily to a more stable form (O₂). Ozone systems require shredders and mixers to expose the waste to the bactericidal agent. Ozone has been used for water treatment and air purification. At concentrations greater than 0.1 ppm, ozone can cause eye, nose and respiratory tract irritation. As with other chemical treatment technologies, regular tests should be conducted to ensure that the microbial inactivation standard is met.

Promession is a new technology that combines a mechanical process and the removal of heat to destroy anatomical waste. It involves cryogenic freeze-drying using liquid nitrogen and mechanical vibration to disintegrate human

remains into powder before burial. The process speeds up decomposition, reduces both mass and volume, and allows the recovery of metal parts.

Emerging technologies for destroying hazardous chemical waste include gas phase chemical reduction, base-catalysed decomposition, supercritical water oxidation, sodium reduction, vitrification, superheated steam reforming, ozonation, Fe-TAML/peroxide treatment (see section 8.11.3), biodegradation, mechanochemical treatment, sonic technology, electrochemical technologies, solvated electron technology, and phytotechnology (Global Environment Facility, 2004; EPA, 2005). These emerging technologies are not ready for routine application to health-care waste.

8.11 Applications of treatment and disposal methods to specific waste categories

Treatment options should be chosen according to the national and local situation. Below are examples from middle- and low-income countries of treatment methods applied to specific components of health-care waste.

8.11.1 Sharps

Improper disposal of sharps waste poses a high risk of disease transmission among health-care workers, waste workers and the general public.

In India, sharps are often collected in cardboard safety boxes and burned in small incinerators. Several non-burn methods have been developed in response to concerns about air pollution and the short lifespan of brick incinerators (WHO, 2005a; PATH, 2007). The methods generally entail the following steps:

1. using onsite mechanical needle cutters or electric needle destroyers
2. shredding the treated plastic parts
3. burying the metal pieces in sharps pits
4. remelting the plastics for recycling.

Alternatively, the sharps waste can be autoclaved, shredded and then encapsulated in cement blocks that later become useful items such as hospital benches.

A study in Ukraine used mechanical needle cutters, steam treatment of the separated plastic and needle portions in existing autoclaves, with the options of remelting the plastic syringe parts in recycling plants and burying the needle portions or melting them in a foundry (Laurent, 2005).

Similarly, a pilot study by the Swiss Red Cross in Kyrgyzstan used needle cutters, treated the separated plastic syringes and needles in an autoclave, shredded the plastics in a locally made hammer-mill shredder, and sold the plastic pieces to a plastics manufacturer that remelted the plastics to make coat hangers, flower pots and other commodities (Emmanuel, 2006). Needle cutters were used in Guyana, with the plastic portions treated as infectious waste and the needle portions collected in a 45-gallon plastic barrel with an aluminium funnel. A sharps barrel could hold 150 000 needles. Regular cleaning and maintenance of the needle cutters was found to be crucial (Furth, 2007).

In the Philippines, 19.5 million auto-disable syringes collected in 5-litre safety boxes during a one-month mass immunization campaign were handled in one of several ways (Emmanuel, Ferrer & Ferrer, 2004):

- treated in a centralized autoclave facility and buried in special landfill trenches
- treated in a centralized microwave facility, shredded and buried in the landfill
- buried in concrete vaults
- buried in sharps pits with clay or cement floors.

A concrete vault design is shown in Figure 8.5. The groundwater level should be considered, to avoid flooding of the vault. The feeding door should be suitable to the size of the sharps container.

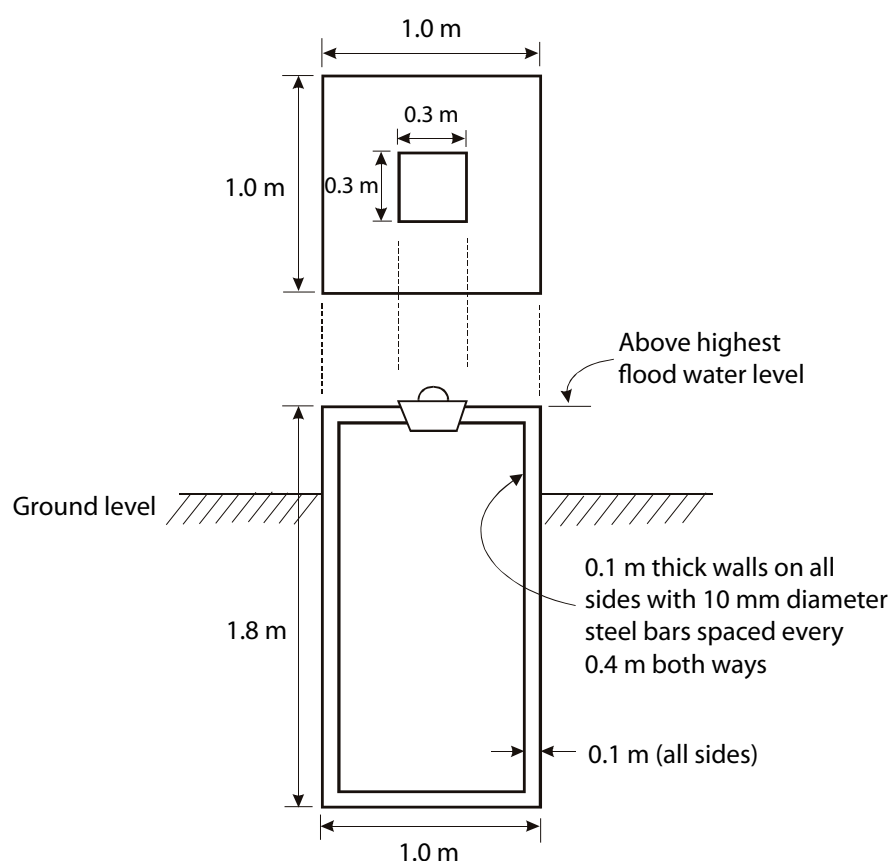

Source: Adapted from Emmanuel, Ferrer & Ferrer (2004)

Figure 8.5 Sample design of a concrete sharps vault

Studies have been conducted to modify existing gravity-fed autoclaves for treating sharps and other infectious wastes (ETLogHealthGmbH, 2007; Emmanuel, Kiama & Heekin, 2008). Modifications include adding special loading baskets, air filters and changing the process cycle to include steam flushing and several pressure pulses to remove air and meet a minimum disinfection level inside the waste containers.

8.11.2 Anatomical waste, pathological waste, placenta waste and contaminated animal carcasses

The treatment of anatomical, pathological, and placenta and fetal remains wastes may be bound by sociocultural, religious and aesthetic norms and practices. Two traditional options have been:

- interment (burial) in cemeteries or special burial sites
- burning in crematoria or specially designed incinerators.

A more recent option is alkaline digestion, especially for contaminated tissues and animal carcasses. Promession is a newer technology designed especially for human cadavers. In some countries, placenta waste is composted or buried in placenta pits designed to facilitate natural biological decomposition. More information about treatment disposal methods of anatomical waste can be found in Annex 6.

8.11.3 Pharmaceutical waste

Pharmaceutical waste can be minimized by good inventory control or a “just-in-time” inventory strategy; by purchasing drugs in the dosages routinely administered; by monitoring expiration dates so that existing stock is used before newly arrived supplies (also known as good “stock rotation”); by replacing prepackaged unit dose liquids with patient-specific oral doses; and other good management practices (Practice Greenhealth, 2008).

Before treatment, pharmaceutical waste should be labelled and sorted using proper personal protective equipment. Pharmaceutical waste can be sorted according to dosage form (solids, semi-solids, powders, liquids or aerosols) or by active ingredient, depending on the treatment options available. Special consideration is needed for controlled substances (e.g. narcotics), anti-infective drugs, antineoplastic and cytotoxic drugs, and disinfectants.

Several options exist for small quantities of pharmaceutical waste:

- return of expired pharmaceuticals to the donor or manufacturer;
- encapsulation and burial in a sanitary landfill;
- chemical decomposition in accordance with the manufacturer’s recommendations if chemical expertise and materials are available;
- dilution in large amounts of water and discharge into a sewer for moderate quantities of relatively mild liquid or semi-liquid pharmaceuticals, such as solutions containing vitamins, cough syrups, intravenous solutions and eye drops.

Antibiotics or cytotoxic drugs should not be discharged into municipal sewers or watercourses.

For large quantities of pharmaceutical waste, the options available include:

- encapsulation and burial in a sanitary landfill;
- incineration in kilns equipped with pollution-control devices designed for industrial waste and that operate at high temperatures;
- dilution and sewer discharge for relatively harmless liquids such as intravenous fluids (salts, amino acids, glucose).

Some emerging technologies include large-scale ozonation and decomposition using iron-tetraamidomacrocyclic ligand (Fe-TAML) peroxide catalysis. These technologies should be evaluated carefully, because many do not have an established record for treating health-care-related pharmaceutical waste.

8.11.4 Cytotoxic waste

Chemotherapeutic waste, including cytotoxic, antineoplastic and cytostatic waste, should first be minimized by careful segregation, purchasing optimal drug quantities, using proper spill containment and clean-up procedures, and substituting environmentally persistent drugs with degradable drugs, where possible.

Cytotoxic waste is highly hazardous and should never be landfilled or discharged into the sewerage system. Disposal options include:

- return to the original supplier
- incineration at high temperatures
- chemical degradation in accordance with manufacturers’ instructions.

Full destruction of all cytotoxic substances may require incineration temperatures up to 1200 °C and a minimum gas residence time of two seconds in the second chamber. The incinerator should be equipped with gas-cleaning equipment. Incineration at lower temperatures may release hazardous cytotoxic vapours into the atmosphere. Incineration in most municipal incinerators, in single-chamber incinerators or by open-air burning, is inappropriate for the disposal of cytotoxic waste.

Chemical degradation methods, which convert cytotoxic compounds into non-toxic/non-genotoxic compounds, can be used for drug residues and for cleaning contaminated urinals, spillages and protective clothing (IARC, 1983; IARC, 1985). These methods are not used widely and require special knowledge. They are not appropriate for treating contaminated body fluids. The International Agency for Research on Cancer (IARC) Unit of Gene-Environment Interactions can be contacted for further information.¹⁵ Further information can also be found in Annex 3.

It should be noted that neither incineration nor chemical degradation currently provides a completely satisfactory solution for treating waste items, spillages or biological fluids contaminated by antineoplastic agents. Until such a solution is available, hospitals should exercise the utmost care in the use and handling of cytotoxic drugs.

Where neither high-temperature incineration nor chemical degradation methods are available, and where exportation of cytotoxic wastes for adequate treatment to a country with the necessary facilities and expertise is not possible, encapsulation or inertization may be considered as a last resort. Alkaline hydrolysis and some of the emerging technologies may have useful applications in the destruction of cytotoxic waste.

8.11.5 Chemical waste

Chemical safety and hazardous chemical waste management should ideally be the subject of a national strategy with an infrastructure, cradle-to-grave legislation, competent regulatory authority and trained personnel.

Improving the management of chemical waste begins with waste minimization. Minimization options include:

- substituting highly toxic and environmentally persistent cleaners and solvents with less toxic and environmentally friendly chemicals;
- using minimum concentrations where possible;
- ensuring good inventory control (i.e. “just-in-time” purchasing);
- designing storage areas well;
- integrating pest management;
- keeping disinfecting trays covered to prevent loss by evaporation;
- developing spill prevention and clean-up procedures;
- recovering solvents using fractional distillation.

Where allowed by local regulations, non-recyclable, general chemical waste, such as sugars, amino acids and certain salts, may be disposed of with municipal waste or discharged into sewers. However, official permission from the appropriate authority may be required, and the types and quantities of material that can be discharged may be limited. Generally, conditions for discharge may include restrictions on pollutant concentrations, content of suspended solids, temperature, pH, and, sometimes, rate of discharge. Unauthorized discharge of hazardous chemicals can be dangerous to sewage treatment workers and may adversely affect the functioning of sewage treatment works. Petroleum spirit (volatilizes to produce flammable vapours), calcium carbide (produces flammable acetylene gas on contact with water) and halogenated organic solvents (many compounds are environmentally persistent or ecologically damaging) should not be discharged into sewers.

It is not possible to dispose both safely and cheaply of large quantities of hazardous chemical waste without using sophisticated treatment methods. The appropriate means of storage and disposal is dictated by the nature of the hazard presented by the waste. The following measures are suggested:

- Hazardous chemical wastes of different composition should be stored separately to avoid unwanted chemical reactions.
- Hazardous chemical waste should not be discharged into sewerage systems.

¹⁵ See <http://www.iarc.fr>

- Large amounts of chemical waste should not be buried, because they may leak from their containers, overwhelm the natural attenuation process provided by the surrounding waste and soils, and contaminate water sources.
- Large amounts of chemical disinfectants should not be encapsulated, because they are corrosive to concrete and sometimes produce flammable gases.

An option for disposing of hazardous chemicals is to return them to the original supplier, who should be equipped to deal with them safely. Where such an arrangement is envisaged, appropriate provisions should be included in the original purchase contract for the chemicals. Preferably, these wastes should be treated by a specialist contractor with the expertise and facilities to dispose safely of hazardous waste. Use of certain products for non-medical purposes may also be considered; for example, use of outdated disinfectants to clean toilets is often acceptable.

Photochemicals should be collected separately, because there is a recovery value from silver compounds contained in the solutions. Recovery of silver from photoprocessing wastewater may be possible using cation exchange, electrolytic recovery or filtration. Spent fixing bath and developing bath solutions should be carefully mixed and the neutralized solution stored for a minimum of one day. The mixture should be diluted (1:2) and very slowly poured into a sewer.

8.11.6 Waste containing heavy metals

Some health-care wastes contain heavy metals, such as high concentrations of cadmium from dry-cell batteries, and mercury from thermometers, sphygmomanometers, cantor tubes, dilators, mercury switches and some button-shaped batteries.

A WHO policy paper on mercury in health care outlines a strategy that includes developing safe mercury clean-up, handling and storage procedures; reducing unnecessary use of mercury equipment; replacing mercury-containing products with mercury-free alternatives; and supporting a replacement of the use of mercury-containing devices in the long term (WHO, 2005b). Wastes containing mercury or cadmium should not be burned or incinerated. Cadmium and mercury volatilize at relatively low temperatures and can cause atmospheric pollution.

In some countries, mercury- or cadmium-containing wastes can be sent to facilities that specialize in the recovery of heavy metals. It may also be possible to send back the waste to the suppliers of the original equipment, with a view to reprocessing or final disposal. Exporting the waste to countries with the expertise and facilities for its adequate treatment should also be considered, but only within the rules laid down by the Basel Convention. If none of the above options are feasible, the wastes would have to go to a disposal or storage site designed for hazardous industrial waste.

The Secretariat of the Basel Convention has been developing technical guidelines on the environmentally sound management of mercury waste (UNEP, 2012). The guidelines include mercury waste prevention and minimisation, handling, interim storage, transportation, treatment, recovery, long-term storage and disposal. The United Nations Development Programme has developed detailed guidance on the clean-up, transport and interim storage of mercury waste from health-care facilities (UNDP, 2010).

8.11.7 Radioactive waste The treatment and disposal of radioactive waste is generally under the jurisdiction of a nuclear regulatory agency, which defines clearance levels and waste classifications according to activity levels and half-lives of the radionuclides present. A radioactive waste-management plan should include a programme of waste minimization. The primary methods of waste minimization are source reduction, extended storage for decay of radioactivity, and substitution with a non-radioactive alternative. Source reduction strategies include limiting the quantity of radioactivity purchased, and laboratory procedures that reduce the volume of waste generated. Substitution means replacing long-lived radionuclides with shorter half-life radionuclides or non-radioactive substitutes, where possible.

Unsealed sources – short-lived radionuclides

Three disposal methods are possible for low-level radioactive waste:

- “decay in storage”, which is the safe storage of waste until its radiation levels are indistinguishable from background radiation; a general rule is to store the waste for at least 10 times the half-life of the longest lived radionuclide in the waste (more information can be found in Chapter 7);
- return to supplier;
- long-term storage at an authorized radioactive waste disposal site.

Containers used for storing radioactive waste should be clearly identified (marked with the words “RADIOACTIVE WASTE” and the radiation symbol) and labelled to show the activity of the radionuclide on a particular date, period of storage required, origin of the waste, surface dose rate on a particular date, quantity and responsible person. Facilities should segregate radioactive waste according to the length of time needed for storage: short-term storage (half-lives less than 60 days) and long-term storage (half-lives more than 60 days). Decayed but infectious waste should be disinfected before subsequent treatment and disposal.

A health-care facility should ensure that radionuclides are not released to the environment unless:

- the radioactivity released is confirmed to be below the clearance levels; or
- the radioactivity of liquid or gaseous effluents is within limits authorized by a regulatory authority.

Sealed sources and long-lived radionuclides

Sealed sources, long-lived radionuclides and spent sources (e.g. from X-ray equipment) should be returned to the producer or supplier of their original form. Health-care facilities planning to import a sealed source with a radioactivity greater than 100 MBq should require the supplier to accept the source back after expiration of its useful lifetime and within a year after a notification is made. If this is not possible, the waste must be stored in an approved long-term storage facility in keeping with international guidelines. Whether the waste is returned or stored in a long-term facility, the waste should first be “conditioned” to make it suitable for handling, transportation and storage. Conditioning may involve immobilization in concrete, securing the waste in suitable containers and providing additional packaging.

A summary of further practices for radioactive health-care wastes

Disposable syringes containing radioactive residues should be emptied in a location designated for the disposal of radioactive liquid waste. Syringes should then be stored in a sharps container to allow decay of any residual activity, before normal procedures for disposal of syringes and needles are followed.

It is not appropriate to disinfect radioactive solid waste by wet thermal or microwave procedures.

Solid radioactive waste, such as bottles, glassware and containers, should be destroyed before disposal to avoid reuse by the public.

The drains that serve sinks designated for discharge of radioactive liquids should be identified. If repairs become necessary, radiation levels should be measured when the drain or sewer is opened up, and appropriate precautions should be taken to avoid unacceptable radiation exposures.

Higher-level radioactive waste of relatively short half-life (e.g. from iodine-131 therapy) and liquids that are immiscible with water, such as scintillation-counting residues and contaminated oil, should be stored for decay in marked containers, under lead shielding, until activities have reached authorized clearance levels. Water-miscible waste may then be discharged to the sewerage system, and immiscible waste may be disposed of by the methods recommended for large quantities of hazardous chemical waste.

Radioactive waste resulting from cleaning-up operations after a spillage or other accident should be retained in suitable containers, unless the activity is clearly low enough to permit immediate discharge. If excessive activity enters the sewer accidentally, a large volume of water should be allowed to flow to provide dilution to about 1 kBq per litre. The relevant government agency must be informed urgently if radioactive waste in excess of the permitted amounts has been discharged to sewers, the atmosphere or otherwise into the environment. After the emergency period, the activity of the resulting waste should be assessed and the relevant regulators informed of the circumstances that gave rise to the incident. It is important to learn from such incidents and for working methods to be changed to avoid it happening again.

It is not usually necessary to collect and confine patients' excreta after diagnostic procedures, although ordinary toilets used by such patients should be checked regularly for accumulation of radioactive contamination. In the case of therapeutic procedures involving radionuclides, hospital toilets must be checked for radioactive contamination after each use by patients, unless every patient has an individual toilet. Some countries require the use of separate toilets equipped with delay tanks, also called holding tanks, or special treatment systems for patients undergoing radiotherapy.

8.12 Land disposal

In all waste systems, the removal of the remaining health-care waste materials after minimization or treatment will require access to land for final disposal. In less developed areas, where a municipality or health-care facility lacks the means to treat wastes before disposal, the direct use of a landfill is likely to be required for much of the material produced. The alternative is often an accumulation of health-care waste at medical facilities where it is openly burnt or spread indiscriminately around the facility's grounds. This constitutes a far higher risk of transmission of infection than controlled disposal in a land disposal site, even if the land disposal site is not designed to the precise standards used in higher income places.

There are two distinct types of waste disposal to land:

- **Uncontrolled dumping** is characterized by the scattered, uncontrolled deposit of wastes at a site. It is a practice that almost always leads to acute pollution problems, fires, higher risks of disease transmission and open access to scavengers and animals. **Health-care waste should not be deposited on or around uncontrolled dumps.** The risk to people and animals coming into contact with infectious pathogens or hazardous materials is obvious, with the further risk of subsequent disease transmission through direct contact, wounds, inhalation or ingestion, as well as indirectly through the food chain or a pathogenic host species (Figure 8.6).
- **Controlled landfilling** represents various types of disposal to land characterized by better operating practices and design improvements to reduce health and environmental impacts. The first step to improvement is "controlled dumping", where small improvements can restrict environmental consequences and physical access to waste. This is followed by "engineered landfill" where increasing standards of engineering are used to improve geological isolation of wastes from the environment and to allow wastes to be covered daily. Disposing of certain types of health-care waste (infectious and small quantities of pharmaceutical wastes) in engineered landfills is possible within the constraints of local regulations. A well-engineered landfill is designed to minimize contamination of soil, surface water and groundwater; limit atmospheric releases and odours; block access to waste by pests and vectors; and prevent contact with the public. Where skills and resources are available, still higher standards of site preparation are possible to achieve a "sanitary landfill", with trained staff and specialized equipment present onsite to manage operations.

More extensive details on landfill design and operations are provided in the World Bank Technical Paper No. 426 (Rushbrook & Pugh, 1999).

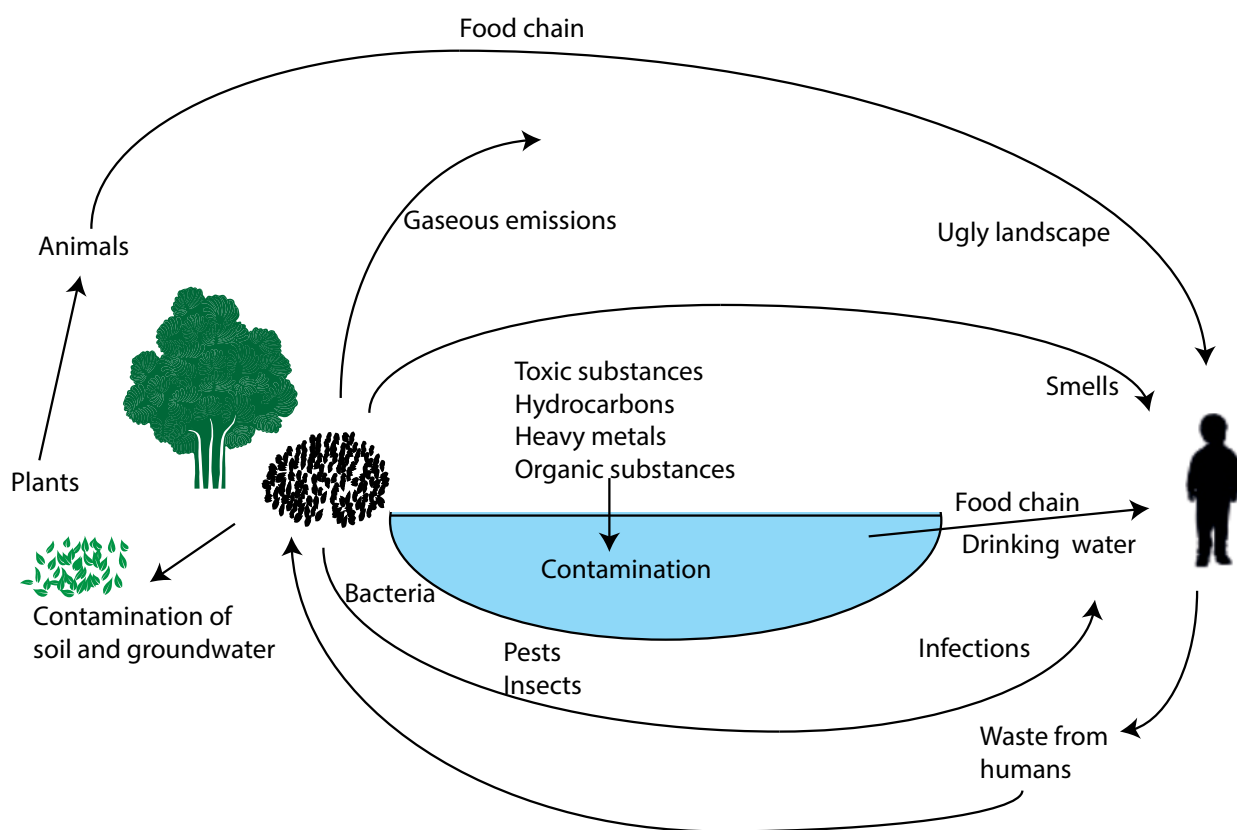

Source: Adapted from Oeltzschner & Mutz (1996); reproduced with the kind permission of Deutsche Gesellschaft für Technische Zusammenarbeit GmbH

Figure 8.6 Routes of exposure to hazards caused by open dumping

8.12.1 Municipal and other external disposal sites

Without treatment

If a municipality or health-care facility lacks the means to treat wastes before disposal, the use of a landfill is a realistic option to protect public health. A starting point can be to use a site operated in a controlled manner that may already exist for municipal waste. In some countries, there may also be suitable sites provided by private operators. Where a municipal waste landfill is available, it is possible to deposit health-care waste safely in two ways:

- In a shallow hollow excavated in mature municipal waste (preferably over three months old) immediately in front of the base of the working face where waste is being tipped. When a load of health-care waste has been deposited, it would be covered during the same day by the advancing tipping face of fresh municipal waste (preferably creating a layer of municipal waste around 2 m thick). Scavenging in this part of the site must be prevented. The same method is often used for hazardous solid industrial wastes, where the specific intent is to prevent animals and scavengers from re-excavating the waste materials once they have been deposited.
- In a deeper (1–2 m) pit excavated in a covered area of mature municipal waste (i.e. waste at least three months old). The pit is then backfilled with the mature municipal waste removed previously, and an intermediate soil cover (approximately 30 cm) or topsoil cover (up to 1 m). Scavenging in this part of the site must be prevented.

After treatment

In more developed situations where health-care waste is treated, the residual material is typically disposed of in landfill sites. Upgrading from open dumping directly to more sophisticated sanitary landfills may be technically

and financially difficult for many municipalities. However, this is no reason for municipal authorities to abandon the move towards more controlled and safer land-disposal techniques. Some of the essential design elements are outlined in Box 8.2.

Box 8.2 Essential elements for the design and operation of sanitary landfills

- Controlled access to the site; designation and supervision of working areas for waste delivery.
 - Presence of personnel capable of effective control of daily operations.
 - Division of the site into manageable phases of operation, each appropriately prepared before landfilling starts in each phase.
 - Adequate sealing of the base and sides of the site to minimize the movement of wastewater (leachate) off the site.
 - Adequate mechanisms for leachate collection and, where necessary, treatment systems to reduce the pollution potential before discharge offsite.
 - Organized deposit of wastes in small working areas, which allow waste to be spread, compacted and covered daily.
 - Surface waste drainage trenches around site boundaries.
 - Placement of final cover to minimize rainwater infiltration when each phase of the landfill is completed.
-

Certain types of health-care waste, such as anatomical waste, will still have an offensive visual impact after treatment and preferably should not be landfilled. Disposing of such waste in landfill may also be culturally or religiously unacceptable in many countries. Such wastes should be placed in approved burial grounds or cremated. If this is not possible, these wastes could be placed in containers or rendered unrecognizable before disposal. In some countries, cemetery design must also meet minimum official standards.

Ash from incineration is conventionally considered to be hazardous by virtue of its likely heavy metal content and the dioxins and furans it may contain. Ash should preferably be disposed of in sites designed for hazardous wastes; for example, placed in designated cells at engineered landfills, encapsulated and placed in specialized monofill sites, or disposed of in an ash pit in the ground.

Before health-care wastes are sent for disposal, it is prudent for the management of a health-care facility to inspect the landfill site to ensure there is sensible control of waste deposition.

Safe burial on hospital premises

Minimal approaches to health-care waste management need to be used in remote health-care facilities and underdeveloped areas. In addition, minimal practices may also be necessary in temporary refugee encampments and areas experiencing exceptional hardship. Consequently, the safe burial of waste on hospital premises may be the only viable option available at that time. Even in these difficult circumstances, the hospital management can establish the following basic principles:

- Access to the disposal site should be restricted to authorized personnel only.
- The burial site should be lined with a material of low permeability, such as clay, dung and river silt, if available, to prevent pollution of shallow groundwater and nearby wells.
- New water wells should not be dug near the disposal pit.
- Only infectious health-care waste should be buried (if general hospital waste were also buried on the premises, available space would be quickly filled).
- Larger quantities (<1 kg) of chemical wastes should not be buried at one time; however, burying small quantities occasionally is less likely to create adverse pollution.
- The burial site should be managed as a landfill, with each layer of waste covered by a layer of soil to prevent odours and contact with the decomposing waste, and to deter rodents and insects.

The design and use of a burial pit is illustrated in Figure 8.7. Once the pit is constructed, the safe burial of waste in minimal circumstances depends critically on staff following sensible operational practices. This must be insisted upon, and the local health-care manager must realize their responsibility for making an organized waste-disposal system work properly.

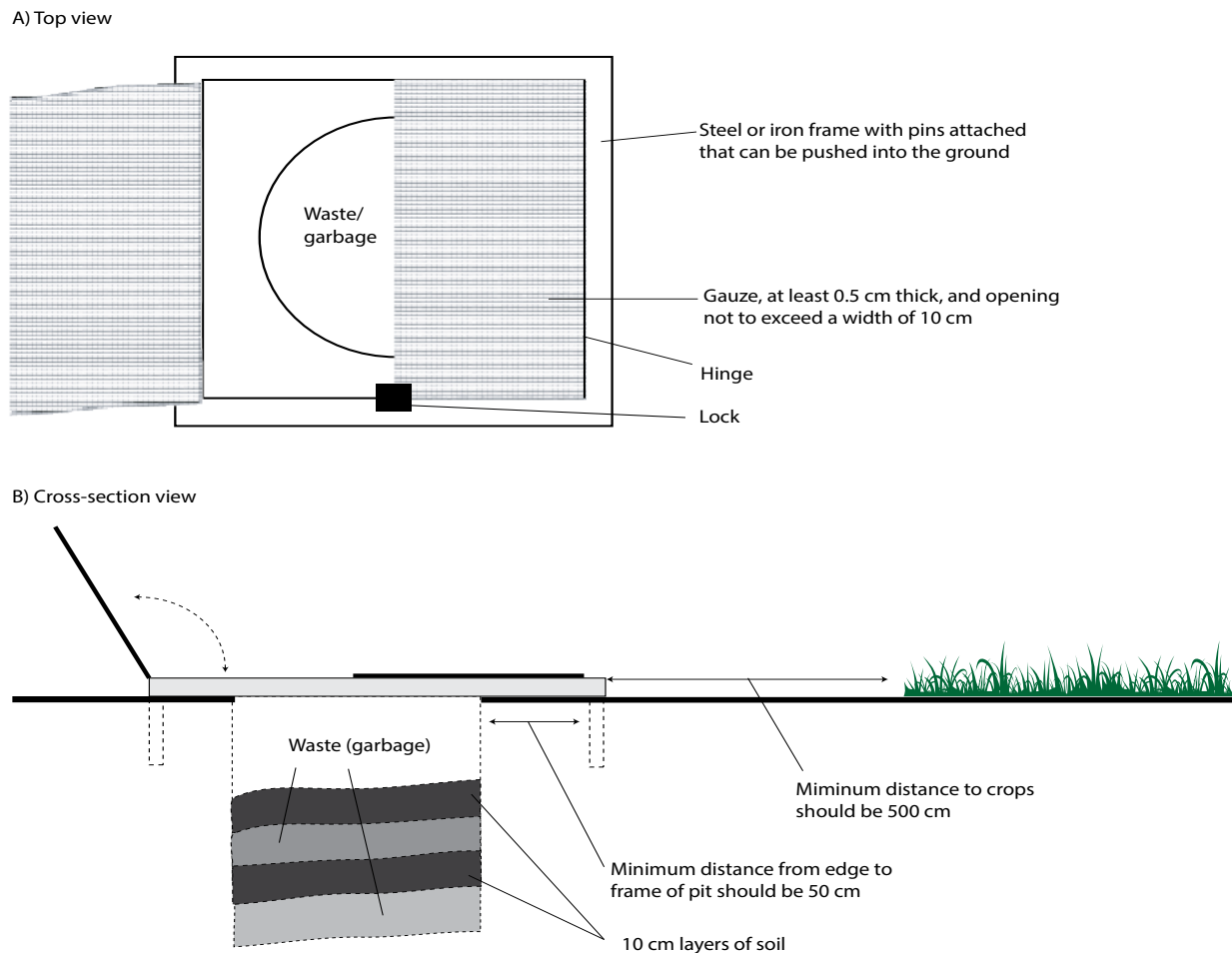

Source: COSsen Zuid-Holland (2006)

Figure 8.7 Example of a low-cost pit cover

Safe onsite burial is practicable only for relatively limited periods (i.e. 1–2 years), and for relatively small quantities of waste (i.e. 5–10 tonnes in total). Where these conditions are exceeded, a longer term solution, probably involving disposal at a land-disposal site away from the health-care facility, should be found.

Another example of an onsite burial waste pit is shown and outlined in Chapter 14.

8.13 Minimum approach to treatment and disposal

Hazardous health-care waste should be treated to reduce the potential for harm. At a minimum, this entails segregation and other practices to minimize the amount of waste that needs to be treated; a treatment process that achieves at least the minimum required disinfection level; and safe disposal. Treatment can be done on the premises or at a centralized treatment facility. When treating onsite, the technology should be carefully selected based on waste characteristics, technology capacity and requirements, environment and safety factors, and cost. In

low-income settings, for example, this may mean modifying an existing autoclave or using a commonly available disinfectant such as hypochlorite. Other health-care facilities may be able to invest in small steam treatment units or use existing incinerators with air-pollution control equipment. Anatomical waste can be buried in cemeteries or approved burial sites. Except for sharps waste, treated waste can be disposed of with regular municipal solid waste.

In extreme circumstances where no treatment is possible, hazardous health-care waste from small health-care facilities could be buried within the premises of the facility where public access can be restricted. A safe burial pit design, like the one shown in Figure 8.7, should be used. Larger health-care facilities should make arrangements with a local landfill to provide a special cell or pit, daily soil cover, and restricted access. Encapsulation, inertization and land disposal could be used for some pharmaceutical and chemical wastes, as well as sharps waste. A well-designed sharps pit is another minimum option for sharps waste.

8.14 Desirable improvements to the minimum approach

Improving segregation and waste minimization are important initial steps towards improving existing waste-treatment systems. For health-care facilities that already use autoclaves, microwave units or other steam-based technologies, the addition of a shredder, grinder and/or compactor, especially for sharps waste, is an option. Scheduling regular validation tests, documenting test results and improving ventilation are important improvements. The health-care facility should also adopt good preventive maintenance procedures.

Health-care facilities that use chemical treatment systems should take extra precautions to ensure the safety and health of their workers. It may be possible to find less hazardous but equally effective chemical disinfectants. Minimizing the environmental impact of air, liquid and solid releases of the chemical residues or by-products is also important. The facility should conduct periodic validation tests and adjust the treatment parameters using the minimum effective chemical concentrations. As with all technologies, periodic maintenance is essential.

Health-care facilities that use incineration may be able to further minimize air emissions by adding air-pollution control devices or upgrading the existing flue gas cleaning system. The health-care facility should also adopt the primary measures outlined in the BAT/BEP guidelines of the Stockholm Convention (see section 4.3.3 of this document). Another issue that is often neglected is proper handling and disposal of toxic incinerator ash. Incinerator stack tests can be expensive but are a necessary tool for improving the combustion process and for ensuring compliance with emission limits. Health-care facilities should also consider installing continuous emission monitoring systems. Periodic maintenance is a must for any incinerator. If the incinerator is reaching its end of life, priority consideration should be given to alternative technologies with lower pollutant releases.

With regard to land disposal, the health-care facility could work with other stakeholders and the local municipal authorities to upgrade the existing landfill or construct a sanitary landfill, if necessary, for the safe disposal of waste in the area.

Key points to remember

Many health-care waste-treatment systems are commercially available today. The choice of technology depends on the characteristics of the waste of the health-care facility, the capabilities and requirements of the technology, environment and safety factors, and costs. Treatment technologies employ thermal, chemical, irradiative, biological or mechanical processes. The common types of treatment technologies are:

- autoclaves
- integrated or hybrid steam-based treatment systems
- microwave treatment technologies
- dry-heat treatment technologies
- chemical treatment technologies
- incinerators.

These technologies could be supplemented by post-treatment shredders, grinders and compactors. For most technologies, except incinerators, validation testing is needed to ensure that a minimum level of disinfection can be achieved. Autoclaves come in a wide range of sizes and can be classified according to the method of air removal. Integrated steam-based treatment technologies incorporate various mechanical processes to improve the treatment efficiency. Incinerators can range from small batch units to large complex treatment plants. Incinerators should have flue gas cleaning systems to minimize pollutant releases and meet national or international emission limits. Small-scale incineration is a transitional means of disposal for health-care waste. When investing in new technologies, priority consideration should be given to technologies that do not produce dioxins or furans. Regardless of the technology, the health-care facility should have an annual budget for periodic maintenance and repair.

Health-care facilities can work with municipal authorities and other stakeholders to gradually improve the disposal of waste in landfills. Among the desirable features of a landfill are:

- restricted access to prevent scavenging
- daily soil cover to prevent odours, and regular compaction
- organized deposit of wastes in small work areas
- isolation of waste to prevent contamination of groundwater and surrounding areas
- trained staff.

In circumstances where sanitary or engineered landfills are not available, various options are possible to minimize the transmission of infections and adverse impacts on the environment from hazardous health-care waste.

8.15 References and further reading

References

Batterman S (2004). *Assessment of small-scale incinerators for health care waste*. Report prepared for the Protection of the Human Environment. Geneva, World Health Organization (http://www.who.int/water_sanitation_health/medicalwaste/en/smincinerators.pdf).

BREF (Best Available Technology Reference) (2006). *Integrated pollution prevention and control: reference document on the best available techniques for waste incineration*. BREF 08.2006. Seville, EU Joint Research Centre, Institute for Prospective Technologies Studies.

COSsen Zuid-Holland (2006). *Waste and medical waste in Bamenda: advisory report*. Netherlands, Stichting Dordrecht-Bamenda.

Devine A et al. (2007). Testing the efficacy of a combination of microwave and steam heat for log reduction of the microbial load following a simulated poultry mass mortality event. *Applied Biosafety*, 12(2):79–84.

DoE (United States Department of Energy) (2012). *Thermal treatment technologies* [fact sheet]. Argonne, Illinois, Argonne National Laboratory, DoE (web.ead.gov/dwm/techdesc/thermal/index.cfm).

- Emmanuel J (2001). *Non-incineration medical waste treatment technologies*. Washington, DC, Health Care Without Harm.
- Emmanuel J, Ferrer M, Ferrer F (2004). *Waste management and disposal during the Philippine Follow-Up Measles Campaign 2004*. Manila, Joint report of Health Care Without Harm and the Philippine Department of Health.
- Emmanuel J (2006). *Medical waste management in Bishkek, Kyrgyzstan*. Bishkek, Kyrgyzstan, Swiss Red Cross.
- Emmanuel J, Stringer R (2007). *For proper disposal: a global inventory of alternative medical waste treatment technologies*. Arlington, Health Care Without Harm.
- Emmanuel J, Kiama J, Heekin H (2008). *Testing a waste treatment autoclave at a hospital in Tanzania: a technical brief*. Reston, Virginia, UNDP GEF Health Care Waste Project and AGENDA.
- EPA (United States Environmental Protection Agency) (1994). *Technical assistance manual: state regulatory oversight of medical waste treatment technologies*. Washington, DC, United States EPA.
- EPA (1996). *Technical assistance manual: state regulatory oversight of medical waste treatment technologies*. Washington, DC, United States EPA.
- EPA (2005). *Reference guide to non-combustion technologies for remediation of persistent organic pollutants in stockpiles and soil*. Report no. EPA-542-R-05-006. Washington, DC, United States EPA.
- EPA (2011). *Standards of performance for new stationary sources and emissions guidelines for existing sources: hospital/medical/infectious waste incinerators – final rule amendments, 40 CFR Part 60*. Washington, DC, United States EPA.
- European Parliament Council of the European Union (2000). *Directive 2000/76/EC on the incineration of waste. Annex V*.
- ETLog Health GmbH (2007). *Infection prevention – health sector: objective D: health care waste management*. PPP Project – SEA, Berlin. WHO Consultation on Health Care Waste, Geneva, 20–22 June 2007.
- European Commission Scientific Steering Committee (2003). *Updated opinion and report on a treatment of animal waste by means of high temperature (150 °C, 3 hours) and high pressure alkaline hydrolysis*. Brussels, Scientific Steering Committee, European Commission, Health & Consumer Protection Directorate-General (http://ec.europa.eu/food/fs/sc/ssc/out297_en.pdf).
- Ferraz M, Afonso SA (2003). Dioxin emission factors for the incineration of different medical waste types. *Archives of Environmental Contamination and Toxicology*, 44(4):460–466.
- Furth R (2007). *Needle remover acceptability assessment report: Guyana safer injection project*. Report prepared for the United States Agency for International Development. Boston, Initiatives Inc.
- Global Environment Facility (2004). *Scientific and Technical Advisory Panel (STAP) of the Global Environmental Facility: non-combustion technologies for the destruction of POPs stockpiles*. Report No. GEF/C.23/Inf.19. Washington, DC, Global Environment Facility Council.
- IARC (International Agency for Research on Cancer) (1983). *Laboratory decontamination and destruction of carcinogens in laboratory waste: some hydrazines*. IARC Scientific Publications, No. 54. Lyon, International Agency for Research on Cancer.

- IARC (1985). *Laboratory decontamination and destruction of carcinogens in laboratory waste: some antineoplastic agents*. IARC Scientific Publications, No. 73. Lyon, International Agency for Research on Cancer.
- Laurent E (2005). *Injection safety health care waste management pilot project needle removing and plastic recycling*. Copenhagen, Ukraine Ministry of Health and World Health Organization EURO.
- Lemieux P et al. (2006). Destruction of spores on building decontamination residue in a commercial autoclave. *Applied and Environmental Microbiology*, 72(2):7687–7693.
- Mathur UB, Verma LK, Srivastava JN (2006). Effects of vermicomposting on microbiological flora of infected biomedical waste. *Journal of Indian Society of Hospital Waste Management*, 5(1):21–27.
- Oeltzschner H, Mutz D (1996). *Guidelines for an appropriate management of domestic sanitary landfills*. Eschborn, Gesellschaft für Technische Zusammenarbeit, Office Fédéral Suisse de la Santé Publique/Bonnard & Gardel Ingénieurs-Conseils.
- PATH (Program for Appropriate Technology in Health) (2007). *Case study: managing sharps waste in Andhra Pradesh*. Seattle, Program for Appropriate Technology in Health.
- Practice Greenhealth (2008). *Managing pharmaceutical waste: a 10-step blue print for health care facilities in the United States*. Reston, Virginia, Practice Greenhealth.
- Rushbrook PE, Pugh MP (1999). *Solid waste landfills in middle and lower-income countries*. World Bank Technical Paper No. 426. Washington, DC, World Health Organization, The World Bank, Swiss Agency for Development and Cooperation and SKAT (Swiss Resource Centre and Consultancies for Development).
- Secretariat of the Stockholm Convention (2006). *Revised draft guidelines on best available techniques and provisional guidance on best environmental practices relevant to Article 5 and Annex C of the Stockholm Convention on Persistent Organic Pollutants*. Geneva, Secretariat of the Stockholm Convention.
- Thacker HL (2004). Chapter 6: Alkaline hydrolysis. In: *Carcass disposal: a comprehensive review*. Kansas, National Agricultural Biosecurity Center Consortium USDA APHIS Cooperative Agreement Project Carcass Disposal Working Group, National Agricultural Biosecurity Center, Kansas State University (<http://fss.k-state.edu/FeaturedContent/CarcassDisposal/PDF%20Files/CH%206%20-%20Alkaline%20Hydrolysis.pdf>).
- UNDP (United Nations Development Programme) (2010). *Guidance on the clean-up, temporary or intermediate storage, and transport of mercury waste from healthcare facilities*. Geneva, United Nations Development Programme Global Environment Facility Project on Healthcare Waste and Secretariat of the Basel Convention (<http://www.gefmedwaste.org/downloads/Guidance%20on%20Cleanup%20Storage%20and%20Transport%20of%20Mercury%20from%20Health%20Care%20July%202010.pdf>).
- UNEP (United Nations Environment Programme) (2001). *Thailand dioxin sampling and analysis program – report*. Geneva, United Nations Environment Programme Chemicals (<http://www.chem.unep.ch/pops/pdf/thdioxsamprog.pdf>).
- UNEP (2006). *Guidelines on best available techniques and provisional guidance on best environmental practices relevant to Article 5 and Annex C of the Stockholm Convention on Persistent Organic Pollutants*. Geneva, Secretariat of the Stockholm Convention (http://www.pops.int/documents/guidance/batbep/batbepguide_en.pdf).
- WHO (World Health Organization) (1999). *Guidelines for the safe disposal of unwanted pharmaceuticals in and after emergencies*. Report No. WHO/EDM/PAR/99.2. Geneva, World Health Organization.
- WHO (2005a). *Safe management of bio-medical sharps waste in India: a report on alternative treatment and non-burn disposal practices*. Report No. SEA-EH-548. New Delhi, World Health Organization Southeast Asia Regional Office.

WHO (2005b). *Mercury in health care*. Policy paper. Geneva, World Health Organization Department of Protection of the Human Environment.

Further reading

Adams J, Bartram J, Chartier Y, eds. (2008). *Essential environmental health standards in health care*. Geneva, World Health Organization.

Allwood M, Wright P, eds. (1993). *The cytotoxic handbook*. Oxford, Radcliffe Medical Press.

Andre M, Hubert S (1991). L'élimination des déchets. [Waste disposal]. *Techniques hospitalières*, 554 (numéro spécial). Compiègne, France, Université de Technologie de Compiègne.

Andrychowski J (1988). *Les déchets hospitaliers et leur incinération, principes de combustion, évolution technologique des fours* [Hospital waste: incineration, principles of combustion, technological development in incinerators]. Paris, Centre de Formation et de Documentation sur l'Environnement Industriel.

ASME (American Society of Mechanical Engineers) (2010). *ASME boiler and pressure vessel code section VIII: rules for construction of pressure vessels*. New York, American Society of Mechanical Engineers.

Association for the Advancement of Medical Instrumentation (2006). *Sterilization, part 1: sterilization in health care facilities*. Arlington, Association for the Advancement of Medical Instrumentation.

Barek J et al. (1987). A method for the efficient degradation of melphalan into non-mutagenic products. *Microchemical Journal*, 36:192–197.

Bartone C (1998). Municipal solid waste management. In: *Brazil: managing pollution problems – the brown environmental agenda*. Report No. 16635. Washington, DC, World Bank.

Bisson M et al. (1995). *Élimination par incinération des déchets liés à l'utilisation de médicaments anticancéreux. Rapport final* [Elimination of wastes related to the use of anti-cancer drugs by incineration. Final report]. Valbonne, Agence de l'Environnement et de la Maîtrise de l'Énergie.

Bisson M (1996). *Élimination par incinération des déchets liés à l'utilisation de médicaments anticancéreux: optimisation couple température-temps. Rapport final* [Elimination of wastes related to the use of anti-cancer drugs by incineration: optimization of temperature-time parameters. Final report]. Valbonne, Agence de l'Environnement et de la Maîtrise de l'Énergie.

Boca B et al. (2002). An overview of the validation approach for moist heat sterilization, Part 1. *Journal of Pharmacy Technology*, 26:62–70.

Bonnard & Gardel Ingénieurs-Conseils SA (1990). *Plan sectoriel des déchets d'hôpitaux, Canton de Fribourg* [Canton of Fribourg: sectoral hospital waste scheme]. Geneva, Bonnard & Gardel Ingénieurs-Conseils SA.

Brunner C (1989). *Handbook of hazardous waste incineration*. Blue Ridge Summit, TAB Books.

Brunner C (1996). *Medical waste disposal*. Reston, Incinerator Consultants Incorporated.

Canadian Council of Ministers of the Environment (1992). *Guidelines for the management of biomedical waste in Canada*. Winnipeg, Canadian Standards Association.

Castegnaro M, Rousselin X (1994). Cancérogènes, mutagènes chimiques et autres substances toxiques: traitement des déchets avant rejet [Carcinogens, chemical mutagens and other toxic substances: treatment of wastes before disposal]. In: Rousselin X et al., eds. *Prévention et sécurité lors de la manipulation des substances génotoxiques utilisées au laboratoire* [Prevention and safety in the manipulation of genotoxic substances used in the laboratory]. Publication ED769. Paris, Institut National de Recherche Scientifique.

- Castegnaro M et al. (1983). Laboratory decontamination and destruction of carcinogens in laboratory wastes: some hydrazines. *IARC Scientific Publications*, 54:1–87.
- Castegnaro M et al. (1985). Laboratory decontamination and destruction of carcinogens in laboratory wastes: some antineoplastic agents. *IARC Scientific Publications*, 73:1–162.
- Castegnaro M et al. (1997). Chemical degradation of wastes of antineoplastic agents. Part 2: six anthracyclines: idarubicin, doxorubicin, epirubicin, pirarubicin, aclarubicin and daunorubicin. *International Archives of Occupational and Environmental Health*, 70:378–384.
- Christen J (1996). *Dar es Salaam Urban Health Project. Health care waste management in district facilities: situational analysis and system development*. St Gallen, Swiss Centre for Development Cooperation in Technology and Management.
- Constructions navales et industrielles de la Méditerranée (1992). *Four de pyrolyse par torche à plasma pour destruction de déchets* [Pyrolytic destruction of waste by plasma torch]. Nantes, Constructions Navales et Industrielles de la Méditerranée.
- Cross F, Hesketh H, Rykowski K (1990). *Infectious waste management*. Lancaster, Technomic Publishing.
- Danish Waste Management Association/Association of Danish Hospital Administrators (DAKFA/FSAD) (1991). *Waste*. Copenhagen, Proceedings of the European Conference on Hospital Waste Management.
- Diaz LF, Savage GM, Eggerth LL (2005). Alternatives for the treatment and disposal of health care wastes in developing countries. *Waste Management*, 25(6):626–637.
- Dunsmore DJ (1986). *Safety measures for use in outbreaks of communicable disease*. Geneva, World Health Organization.
- Emmanuel J, Hrdinka Č, Głuszyński P (2004). *Non-incineration medical waste treatment technologies in Europe*. Prague, Health Care Without Harm Europe.
- European Committee for Standardization (2006). *EN 285:2006+A2:2009. Sterilization – steam sterilizers – large sterilizers*. Brussels, European Committee for Standardization.
- European Committee for Standardization (2009). *EN 13445. Unfired pressure vessels*. Brussels, European Committee for Standardization.
- European IPPC Bureau (2006). *Integrated pollution, prevention and control – reference document on the best available techniques for waste incineration*. Seville, EU Joint Research Centre, Institute for Prospective Technologies Studies (http://www.ineris.fr/ippc/sites/default/files/files/wi_bref_0806.pdf).
- Fritsky KJ, Kumm JH, Wilken M (2001). Combined PCDD/F destruction and particulate control in a baghouse: experience with a catalytic filter system at a medical waste incineration plant. *Journal of Air and Waste Management Association*, 51:1642–1649.
- Hansel S, Castegnaro M, Sportouch M-H (1997). Chemical degradation of wastes of antineoplastic agents. Part 1: cyclophosphamide, ifosfamide and melphalan. *International Archives of Occupational and Environmental Health*, 69:109–114.
- IAEA (International Atomic Energy Agency) (1992). *Treatment and conditioning of radioactive solid wastes*. Report No. TECDOC 655. Vienna, International Atomic Energy Agency.
- IAEA (1993). *Radioactive waste management glossary*. Vienna, International Atomic Energy Agency.
- IAEA (1994). *Classification of radioactive waste*. Safety Series No. 111-F. Vienna, International Atomic Energy Agency.

- IAEA (1995). *The principles of radioactive waste*. Safety Series No. 111-F. Vienna, International Atomic Energy Agency.
- IAEA (1995). *Establishing a national system for radioactive waste management*. Safety Series No. 111-S-1. Vienna, International Atomic Energy Agency.
- IAEA (1996). *International basic safety standards for protection against ionizing radiation and for the safety of radiation sources*. Safety Series No. 115. Vienna, International Atomic Energy Agency.
- IAEA (1996). *Clearance levels for radionuclides in solid materials*. Report No. TECDOC 855. Vienna, International Atomic Energy Agency.
- IAEA (1998). *Clearance of materials resulting from the use of radionuclides in medicine, industry and research*. Report No. TECDOC 1000. Vienna, International Atomic Energy Agency.
- IAEA (in press). *Implementation of safety regulations on radioactive waste management*. Vienna, International Atomic Energy Agency.
- IARC (International Agency for Research on Cancer) (1979). *Report of the first meeting of the working group on methods for containment, destruction and disposal of carcinogenic waste from laboratories*. IARC Technical Report No. 79/002. Lyon, International Agency for Research on Cancer.
- IARC (1991). *IARC monograph on the evaluation of carcinogenic risk of chemicals to humans: some antineoplastic and immunosuppressive agents*. IARC Monographs, No. 26. Lyon, International Agency for Research on Cancer.
- IARC (1994). *IARC monographs on the evaluation of carcinogenic risks to humans. List of IARC evaluations*. Lyon, International Agency for Research on Cancer.
- Johannessen LM et al. (2000). Health care waste management guidance note, May 2000. *Health, Nutrition and Population (HNP) Discussion Papers*. Washington, World Bank.
- Joslyn L (2000). Sterilization by heat. In: Bock S, ed. *Disinfection, sterilization, and preservation*. Baltimore, Lippincott, Williams and Wilkins.
- Lane T, VanderNoot V (2004). *Medical waste management plan*. Albuquerque, New Mexico, Sandia National Laboratories.
- Lewis R (2002). Practical guide to autoclave validation. *Pharmaceutical Engineering*, 22:78–88.
- Liberti A et al. (1994). Optimization of infectious hospital waste management in Italy. Part 1: waste production and characterization study. *Waste Management and Research*, 12:373–385.
- Lunn G, Sansone EB (1987). Reductive destruction of dacarbazine, procarbazine hydrochloride, isoniazid and iproniazid. *American Journal of Hospital Pharmacy*, 44:2519–2524.
- Lunn G et al. (1989). Degradation and disposal of some antineoplastic drugs. *Journal of Pharmaceutical Sciences*, 78:652–659.
- Ministère de la Santé (1990). *Guide sur l'élimination des déchets hospitaliers* [Guide to hospital waste disposal]. Paris, Ministère de la Santé.
- Ministère de la Santé (1991). *Élimination des déchets produits par les professionnels de santé en exercice libéral, enquête sur les conditions actuelles d'élimination* [Disposal of waste produced by health professionals in the course of their duties and survey of current waste disposal conditions]. Paris, Ministère de la Santé.
- Ministère de la Santé (1991). *Enquête nationale sur les conditions actuelles d'élimination des déchets solides hospitaliers* [National survey on current hospital waste disposal conditions]. Paris, Ministère de la Santé.

Monteith DK, Connor TH, Benvenuto JA (1987). Stability and inactivation of mutagenic drugs and their metabolites in the urine of patients administered antineoplastic therapy. *Environmental and Molecular Mutagenesis*, 10:341–356.

Niessen WR (2002). *Combustion and the incineration processes*. New York, Marcel Dekker Inc.

Oates K et al. (1983). Development of a laboratory autoclave system. *Journal of Hospital Infection*, 4:181–190.

Palenik C, Golden L (1994). Effectiveness of two types of sterilizers on the contents of sharps containers. *American Journal of Dentistry*, 7:98–102.

Palenik C et al. (1996). Sterilization of slide sheath anesthetic injection systems placed within sharps containers. *Journal of the Indiana Dental Association*, 76:45–50.

Reinhardt PA, Gordon JH (1991). *Infectious and medical waste*. Chelsea, Michigan, Lewis Publishers.

Rushbrook PE, Pugh MP (1997). *Decision-maker's guide on the planning, siting, design and operation of sanitary landfills in middle- and lower-income countries*. Washington, DC, World Health Organization, The World Bank and SKAT (Swiss Resource Centre and Consultancies for Development).

Rushbrook PE, Zghondi R (2005). *Better health care waste management – an integral component of health investment*. Amman, World Health Organization Centre for Environmental Health Activities Eastern Mediterranean Region Office, and The World Bank, Middle East and North Africa Region.

Office Fédéral Suisse de la Santé Publique, Bonnard & Gardel Ingénieurs-Conseils SA (1994). *Analyse des méthodes d'élimination des déchets infectieux hospitaliers* [Analysis of disposal methods for infectious hospital waste]. Berne, Office Fédéral Suisse de la Santé Publique and Bonnard & Gardel Ingénieurs-Conseils SA.

Secretariat of the Basel Convention (2003). *Technical guidelines on the environmentally sound management of biomedical and health care wastes (Y1; Y3)*. Basel Convention series/SBC No. 2003/3. Châtelaine, Secretariat of the Basel Convention/United Nations Environment Programme.

Secretariat of the Basel Convention (2012). *Technical guidelines on environmentally sound management of mercury waste* (version 24). Geneva, Secretariat of the Basel Convention and UNEP, available at (<http://www.basel.int/Implementation/TechnicalMatters/DevelopmentofTechnicalGuidelines/AdoptedTechnicalGuidelines/tabid/2376/Default.aspx>).

Sheldrake M et al. (1995). Effectiveness of three types of sterilization on the contents of sharps containers. *Quintessence Internet*, 26:771–778.

Shibamoto T, Yasuhara A et al. (2007). Dioxin formation from waste incineration. *Reviews of Environmental Contamination and Toxicology*, 190:1–41.

Tiller T, Linscott A (2004). Evaluation of a steam autoclave for sterilizing medical waste at a university health center. *American Journal of Infection Control*, 32:E9.

Turnberg W (1996). *Biohazardous waste: risk assessment, policy, and management*. New York, John Wiley & Sons Inc.

Vesley D, Lauer J (1995). Decontamination, sterilization, disinfection, and antisepsis. In: Fleming D, Richardson J, Tulis J, eds. *Laboratory safety – principles and practices*, 2nd ed. Washington, DC, American Society for Microbiology.

Vesley D, Lauer J, Hawley R (2000). Decontamination, sterilization, disinfection, and antisepsis. In: Fleming D, Hunt D, eds. *Laboratory safety – principles and practices*, 3rd ed. Washington, DC, American Society for Microbiology.

WHO (World Health Organization) (1985). *Solid waste management selected topics*. Copenhagen, World Health Organization Regional Office for Europe.

WHO (1996). *Suggested guiding principles and practices for the sound management of hazardous hospital wastes*. Regional Consultation on Sound Management of Hospital Waste in Chiang Mai, Thailand, November 1996. New Delhi, World Health Organization Regional Office for South-East Asia.

WHO (1996). *Healthy cities – healthy islands. Guides for municipal solid waste management in Pacific Island countries*. Document Series No. 6. Manila, World Health Organization Regional Office for the Western Pacific.

WHO (2001). *Guidance on minimum approaches for improvements to existing municipal waste dumpsites*. Report No. EUR/01/5021815. Copenhagen, World Health Organization Regional Office for Europe.

WHO (2005). *Managing health care waste disposal: guidelines on how to construct, use, and maintain a waste disposal unit*. Pondicherry, IT Power India; Harare, World Health Organization Africa Region.

WHO (2005). *Management of solid health care waste at primary health care centres: a decision-making guide*. Geneva, Immunization, Vaccines and Biologicals (IVB); Protection of the Human Environment Water, Sanitation and Health (WSH), World Health Organization.

Wilson SJ (1983). Safe disposal of some commonly used injectable antineoplastic drugs. *Journal of Clinical and Hospital Pharmacy*, 8:295–299.

9

Collection and disposal of wastewater

Key questions to answer

What are the risks from health-care wastewater?

What are hazardous and non-hazardous liquid health-care wastes?

When is it possible to discharge liquid health-care waste into a sewerage system and when is it not advisable?

How should liquid health-care waste be handled in the absence of a sewerage system?

How should a sewerage system be designed?

What are primary, secondary and tertiary wastewater treatments?

What are the requirements to operate and maintain a wastewater system?

Why can wastewater disinfection with chlorine be counterproductive?

What are new developments in the treatment of liquid health-care waste?

9.1 Characteristics of health-care wastewater

Health-care wastewater is any water that has been adversely affected in quality during the provision of health-care services. It is mainly liquid waste, containing some solids produced by humans (staff and patients) or during health-care-related processes, including cooking, cleaning and laundry. Health-care wastewater can be divided into the following three categories:

- **Blackwater** (sewage) is heavily polluted wastewater that contains high concentrations of faecal matter and urine.
- **Greywater** (sullage) contains more dilute residues from washing, bathing, laboratory processes, laundry and technical processes such as cooling water or the rinsing of X-ray films.
- **Stormwater** is technically not a wastewater itself, but represents the rainfall collected on hospital roofs, grounds, yards and paved surfaces. This may be lost to drains and watercourses and as groundwater recharge, or used for irrigating hospital grounds, toilet flushing and other general washing purposes.

A more detailed definition of these terms can be found in the World Health Organization's (WHO's) *The health and environment lexicon* (WHO, 2012).¹⁶

9.2 Hazards of wastewater from health-care facilities

A large part of the wastewater from health-care facilities is of a similar quality to domestic wastewater and poses the same risks. Just as domestic wastewater is considered to be potentially infectious, wastewater from health-care facilities must also be considered in a similar manner and precautions taken.

A proportion of the generated wastewater from health-care facilities will pose a higher risk than domestic wastewater. Depending on the service level and tasks of the health-care facility, the wastewater might contain chemicals, pharmaceuticals and contagious biological agents, and might even contain radioisotopes. Sewers of

16 See http://www.who.int/water_sanitation_health/thelexicon/en/index.html

health-care facilities are often not watertight, and a significant part of the wastewater in many places may leak into the groundwater. Often, hospitals are not connected to efficient, working sewage-treatment plants, and sometimes municipal sewerage networks may not even exist. In many developing countries, the major part of health-care wastewater is discharged in surface watercourses or percolates into underlying groundwater aquifers with no or only partial treatment.

9.2.1 Wastewater-related diseases

Improper management, collection, treatment and disposal of wastewater and sludge will result in the pollution of local water sources with pathogens. This can cause numerous waterborne and vector-borne diseases (e.g. malaria and filariasis) by providing breeding places for the vectors, and favours the spread of parasites (e.g. roundworms or *Ascaris lumbricoides*). Fatalities caused by waterborne diseases are shown in Figure 9.1. By disposing of untreated wastewater in the environment, nutrients are biologically degraded in groundwater, lakes and rivers by using oxygen present in fresh water (eutrophication). If the oxygen demand of the wastewater is too high, hypoxia (oxygen depletion) of a watercourse will result in significant environmental degradation. Additionally, the nutrients can increase algal production and algal blooms that will favour potentially hazardous bacteria (e.g. *Cyanobacteria*) and might result in hazardous toxins forming that can cause illnesses, such as from exposure to cyanotoxins. Nitrate in the groundwater from untreated wastewater can result in methaemoglobinaemia, particularly in babies. Wastewater discharged in an uncontrolled manner into the environment can lead to several waterborne diseases that are a threat to human life, especially in developing countries. A selection of these diseases found widely in the world is presented in the following sections.

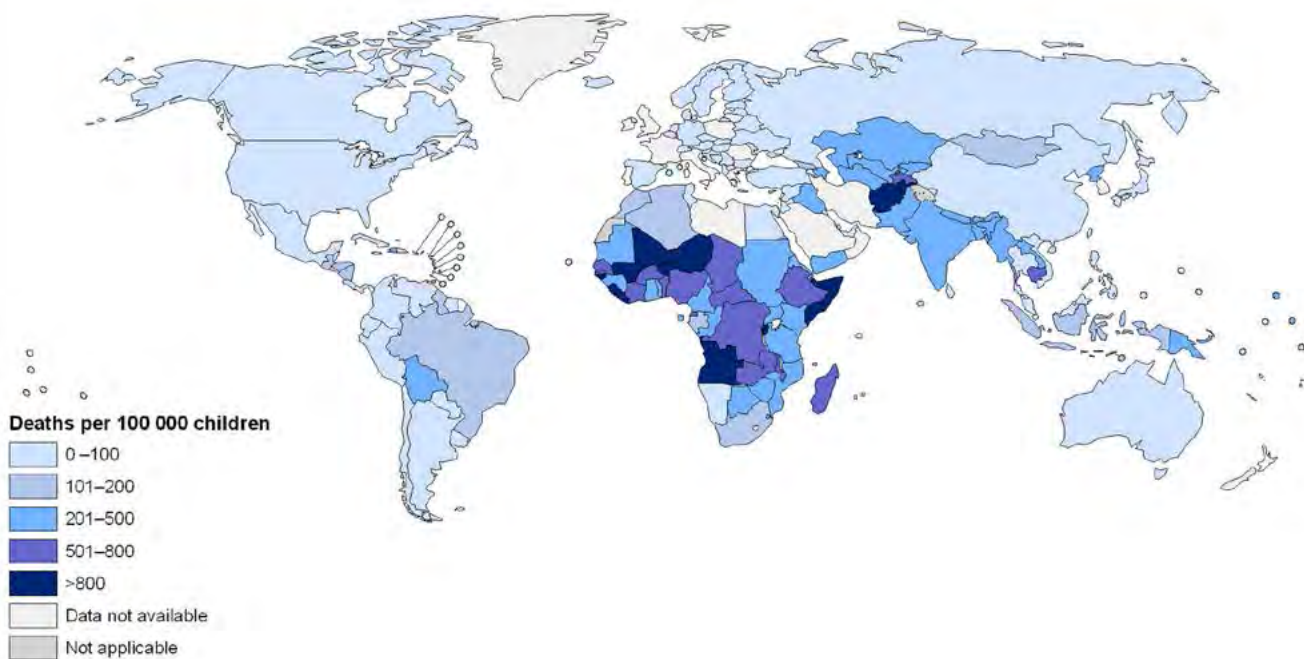

Source: Map generated by WHO based on data from Fewtrell et al. (2007).

Figure 9.1 Deaths due to improper water and sanitation systems per 1000 population

Campylobacteriosis is an infection of the gastrointestinal tract (severe form of diarrhoea). The cause is a bacterium, usually *Campylobacter jejuni* or *Campylobacter coli*. People are exposed to the bacteria after consuming food or water contaminated with human wastes.

Cholera is an acute infection of the intestine caused by the bacterium *Vibrio cholerae*. People become infected after eating food or drinking water that has been contaminated by the faeces of infected individuals.

Hepatitis A and hepatitis E lead to infection and inflammation of the liver. Both infections are transmitted via the faecal–oral route, often through contaminated water due to inadequate sanitation systems. Both hepatitis A and E are found worldwide.

Schistosomiasis is a water-based disease that is considered the second most important parasitic infection after malaria in terms of public health and economic impact. Infections are transmitted when faeces or urine of infected humans are disposed of into water systems. Parasite eggs can infect aquatic snails in which the parasite transforms and divides into second-generation larvae. These are released into fresh water ready to infect humans.

Typhoid fever is a bacterial infection of the intestinal tract and bloodstream caused by the bacteria *Salmonella typhi* and *Salmonella paratyphi*. People become infected by drinking water that has been contaminated by sewage containing the bacteria. The annual incidence of typhoid is estimated to be about 16 million cases worldwide (Crump, Luby & Mintz, 2004).

9.2.2 Hazards from liquid chemicals in wastewater

A major part of liquid chemical waste is disposed of via the sink. The most important chemicals in hospital wastewater are anaesthetics, disinfectants, chemicals from laboratory activities, developer and fixer solutions from photographic film processing, and iodinated X-ray contrast media.

X-ray contrast media contain absorbable organic iodinated compounds (AOX). As AOX are biologically inert and stable, they are excreted almost completely within a day after administration and enter into the wastewater. Little is known about their fate and long-term effects; therefore, the risk associated with their spread in the environment must not be underestimated.

Photochemical wastes (fixer and developer solution from X-ray diagnostics) form a major part of generated chemical waste. Fixer baths contain large amounts of silver. Developing solution can contain formaldehyde, which is a known human carcinogen.¹⁷

Glutaraldehyde solutions are widely used in hospitals to disinfect reusable fibre-optic endoscopes. Formaldehyde-based disinfectants (formalin) are used for dialysers, and disinfection of dialysis equipment and the associated reverse osmosis units, as well as in pathology. As well as exhibiting human toxicity, both chemicals can cause severe water pollution and operational problems within a wastewater treatment plant if discharged to the sewer.

Dental amalgam is an alloy of mercury with other metals and might be set free into wastewater during dental activities if not separated. Mercury is a neurotoxin. It is environmentally persistent and bioaccumulates in the food chain. Mercury might also reach the wastewater by the disposal of laboratory chemicals in sinks or through the drains of maintenance departments if mercury-containing equipment, such as sphygmomanometers, is in use.

9.2.3 Hazards from pharmaceuticals in wastewater

Antibiotics are used extensively for treatment in hospitals. These antibiotics and their metabolites are excreted with urine and faeces and end up in the wastewater stream, a problem recently recognized worldwide. Hospital wastewaters are a source of bacteria with acquired resistance against antibiotics with a level of at least a factor of 2 to 10 times higher than in domestic wastewater. Gene transfer is optimal at high cell densities and under high antibiotic concentrations. Under heterogeneous environmental conditions, this gene transfer can still occur at significant levels and will contribute to the emergence and spread of resistant pathogens, such as methicillin-resistant *Staphylococcus aureus* if the wastewater is not properly treated. Also, in some places, isolates of vancomycin-resistant enterococci have been detected in samples of sewage obtained downstream from hospitals, such as in the Porto area in Portugal (Novais et al., 2005).

¹⁷ See <http://monographs.iarc.fr/ENG/Classification/ClassificationsAlphaOrder.pdf> for more information

Other pharmaceuticals that have been found in wastewater include lipid regulators, analgesics, antidepressants, antiepileptics, antineoplastics, antipyretics, antiphlogistics, antirheumatics, β -blockers, broncholytics, β 2-sympathomimetics, estrogens, secretolytics and vasodilators. Most of them pass through wastewater treatment plants and have been found in drinking-water in high-income, as well as low-income, countries. Ecosystems to which pharmaceutical contaminated wastewaters are discharged can also be adversely affected.

9.2.4 Hazards from radioactive substances

Radioactive waste results from the use of tracers and other radioactive diagnostic and treatment procedures. High-level radioactive waste should be segregated and collected by authorized companies. Waste fluids containing low-level radioactive contents are typically discharged into sewers from, for example, oncology departments. This should not pose a risk to health if the fluids have been stored for a sufficient period of time to permit radioactive decay according to national requirements or the recommendations made in Chapter 9.

9.2.5 Quantity of wastewater

The quantity of wastewater produced in a health-care facility depends on the amount of water used and is best measured by water consumption. The water consumption depends heavily on factors such as the kind of health-care services provided, number of beds, accessibility to water, climatic situation, level of care and local water-use practices.

In high-income countries, wastewater generation in secondary- and tertiary-level hospitals is mainly measured on an inpatient ratio (litre of generated wastewater per patient treatment day). Typical generation rates are (Anonymous, 2001):

- small-medium-sized hospitals: 300–500 l per inpatient per day
- large health-care settings: 400–700 l per inpatient per day
- university hospitals: 500–>900 l per inpatient per day.

In primary health-care clinics, the rate of waste generation is often measured as the sum of the number of inpatients and outpatients. Minimum water quantities required in the health-care setting are (WHO, 2008):

- 40–60 l per inpatient; plus
- 5 l per outpatient; and
- 100 l per surgical procedure.

While a lack of maintenance in the water supply can contribute heavily to high wastewater generation rates, water-saving programmes can efficiently minimize the amount of wastewater produced.

9.2.6 Quality of wastewater by hospital department

Wastewater from health-care facilities contains organic particles (faeces, hairs, food, vomit, paper, fibres), soluble organic material (urea, proteins, pharmaceuticals), inorganic particles (sand, grit, metal particles), soluble inorganic material (ammonia, cyanide, hydrogen sulfide, thiosulfates) and other substances. The composition depends on the source of origin.

General medical areas generate wastewater comparable to domestic wastewater. The urine of patients from some wards (oncology, infectious disease) will probably contain higher amounts of antibiotics, cytotoxics, their metabolites and X-ray contrast media. Additionally, higher concentrations of disinfectants can be found.

Kitchens at hospitals often generate a polluting wastewater stream containing food leftovers, waste from food processing and high concentrations of disinfectants and detergents. Starch, grease, oil and an overall high organic content have the potential to create problems during wastewater management.

Laundries are places where the highest quantity of greywater is produced. Often, the wastewater is hot, has a high pH (alkaline) and may contain high rates of phosphate and AOX if chlorine-based disinfectants are used. Shower blocks also create large volumes of greywater containing dilute concentrations of detergents.

Theatres and intensive-care units generate wastewater with high contents of disinfectants (glutaraldehyde), detergents and pharmaceuticals. Additionally, the organic content can be high due to the disposal of body fluids and rinsing liquids (such as those from suction containers).

Laboratories are a possible source for chemicals in the wastewater stream. Of special relevance are halogenated and organic solvents, colorants from histology and haematology (Gram staining), cyanides (haematology) and formaldehyde and xylene (pathology). Laboratories may also contribute to the presence of blood in wastewater from the emptying of samples into the sinks.

Radiology departments are the main generator of photochemical (developing and fixing) solutions in wastewater and potentially contaminated rinsing water. In some countries, this source of wastewater contamination is declining due to the increasing use of digital X-ray technology.

Haemodialysis requires the disinfection of the dialysers and sometimes the used filters. Accordingly, the concentration of disinfectant in the wastewater can be high.

Dental departments can contaminate wastewater with mercury (amalgam) from the filling of dental cavities if no amalgam separators are installed in the sink waste pipe system.

Central sterile supply departments are one of the main consumers of disinfection solutions, including aldehyde-based disinfectants. Hot water from the sterilizers and detergents from the CD-machine (cleaning and disinfectant) might also increase pollution load in the wastewater.

9.3 Collection and pretreatment of liquid health-care waste

Segregation, minimization and safe storage of hazardous materials are just as important for liquid wastes as they are for solid wastes.

Typically, a system of sewer pipes linked to form a sewerage system will collect wastewater from around a health-care facility and carry it below ground to a central location for treatment or disposal. This treatment plant may be located at a health-care facility or some distance away, where it will also provide treatment for the wider community or municipality. This is known as a “central system”. Where a main sewerage system has not been constructed, wastewater may be collected from medical areas by pipe system and passed into cesspits or septic tanks. This is a “decentralized” collection arrangement, where the wastewater is removed periodically from the pits by a tanker fitted with a sludge pump and taken for treatment and disposal. A decentralized collection and treatment system is not the preferred approach for health-care facilities.

9.3.1 Sewerage systems for health-care facilities

The preferred set-up is to construct separate sewerage systems for wastewater and stormwater (referred to as sanitary sewers and storm sewers). Combined sewerage systems (which transport liquid waste discharges and stormwater together to a common treatment facility) are no longer recommended. The separate collection of grey and blackwater is normally not recommended, because it can cause hydraulic problems (blockages) due to low flow volumes in the collection of the blackwater. Stormwater or rainwater can be collected separately and used for gardens or other purposes that do not need highly processed water, such as toilet flushing, washing vehicles or cleaning outdoor paved areas.

A sufficient number of access holes should be installed in a sewerage system to allow maintenance. The distance between access holes should be <50 m to permit easy access to all subsurface parts of the system. All sewage pipes and access holes should be watertight.

9.3.2 Pretreatment of hazardous liquids

The basic principle of effective wastewater management is a strict limit on the discharge of hazardous liquids to sewers. Chemical waste, especially photochemicals, aldehydes (formaldehyde and glutaraldehyde), colorants and pharmaceuticals, should not be discharged into wastewater (see Figure 9.2) but should be collected separately and treated as a chemical health-care waste. Pretreatment is recommended for wastewater streams from departments such as medical laboratories. This pretreatment could include acid–base neutralization, filtering to remove sediments, or autoclaving samples from highly infectious patients. Non-hazardous chemicals such as syrups, vitamins or eye drops can be discharged to the sewer without pretreatment.



Source: ETLog Health GmbH, Germany

Figure 9.2 Improper disposal of photochemicals into the sewerage system

A grease trap can be installed to remove grease, oil and other floating materials from kitchen wastewater. The trap and collected grease should be removed every 2–4 weeks.

Collected body fluids, small quantities of blood and rinsing liquids from theatres and intensive care can be discharged in the sewer without pretreatment. Precautions against blood spatter should always be taken (e.g. wearing personal protective equipment [PPE] and following standardized handling procedures), and care should be taken to avoid blood coagulation that could block pipes. Larger quantities of blood may be discharged if a risk assessment shows that the likely organic loading in the wastewater does not require pretreatment. Otherwise, blood should be first disinfected, preferably by a thermal method, or disposed of as pathological waste. Blood can also be disposed of directly to a septic tank system (see section 9.7.2) if safety measures are followed.

Note that 5% sodium hypochlorite (NaOCl – bleach) is not effective for disinfecting liquids with a high organic content such as blood and stools. Sodium hypochlorite should never be mixed with detergents or used for disinfecting ammonia-containing liquids, because it might form toxic gases. Lime milk (calcium oxide) can be used to destroy microorganisms in liquid wastes with high organic content requiring disinfection (e.g. stool or vomit during a cholera outbreak). In these cases, faeces and vomit should be mixed with the lime milk in a ratio of 1:2, with a minimum contact time of six hours. Urine can be mixed 1:1, with a minimum contact time of two hours (Robert Koch Institute, 2003).

Wastewater from the dental department should be pretreated by installing an amalgam separator in sinks, particularly those next to patient treatment chairs. Mercury waste must be safely stored. Where there is no existing national system for storing mercury, health-care facilities can follow general guidelines for safe storage (e.g. UNDP, 2010).

Radioactive wastewater from radiotherapy (e.g. urine of patients undergoing thyroid treatment) should be collected separately and stored in a secured place until the levels of radioactivity have decreased to background concentrations. After the required storage time, the wastewater can be disposed of into a sewer.

9.4 Discharge into municipal sewage systems

Discharging wastewater generated from a health-care facility into the municipal sewage system, after adequate pretreatment (see section 9.3.2), is a preferred method if the municipal sewage-treatment plant fulfils the local regulatory requirements.

In countries operating only basic sewerage systems or experiencing epidemics of enteric disease, or with endemic intestinal helminthiasis, the onsite treatment or at least pretreatment of the wastewater before discharge into the municipal sewerage system should be considered.

Typically, the minimum requirements for discharging into a municipal sewerage system are:

- the municipal sewers should be connected to efficient sewage-treatment plants with primary, secondary and tertiary treatment;
- a central treatment plant ensures at least a 95% removal of bacteria;
- the sludge resulting from sewage treatment should be subjected to further treatment, such as anaerobic digestion, leaving no more than one helminth egg per litre in the digested sludge;
- the waste-management system of the health-care facility maintains high standards, ensuring only low quantities of toxic chemicals, pharmaceuticals, radionuclides, cytotoxic drugs and antibiotics in the discharged sewage.

If these requirements cannot be met, the wastewater should be managed and treated as described in sections 9.5 and 9.7.

9.5 Onsite wastewater treatment

Larger health-care facilities, particularly those that are not connected to any municipal treatment plant, should operate their own wastewater-treatment equipment. This could include physical, chemical and biological processes to remove contaminants from the raw sewage. The objective is to produce a treated effluent that is suitable for reuse or discharge back into the environment, usually surface watercourses.

Typically, wastewater treatment involves three stages. The first stage is the removal of solids that are separated by sedimentation (primary treatment). Second, dissolved biological matter is progressively converted into a solid mass using indigenous waterborne bacteria. Some inorganic components will be eliminated by sorption to sludge particles, which are then separated from the liquid phase of the wastewater by sedimentation (secondary treatment). During the third stage (at the end of the treatment process), after the solid and liquid materials are separated, the treated water may be further treated to remove suspended solids, phosphates or other chemical contaminants, or may be disinfected (tertiary treatment).

9.5.1 Wastewater-treatment systems

The most efficient onsite treatment plants for health-care wastewater should include primary, secondary and tertiary treatment.

Primary treatment

The purpose of this first stage is to prevent the damage or clogging of wastewater treatment equipment and to produce a generally homogeneous liquid capable of being treated subsequently biologically or mechanically. A raked screen is used to remove large objects, after which the velocity of incoming wastewater is reduced to allow the settlement of sand, grit and stones. Floating material, such as grease and plastics, is skimmed off, and primary sedimentation tanks are installed to allow faecal solids to settle.

Secondary treatment

The task of secondary treatment is to remove dissolved carbon and nitrogen components by microbial digestion. Bacteria and protozoa consume biodegradable soluble organic material (e.g. sugars, fats, organic short-chain carbon molecules) and bind much of the less soluble fractions into floc particles. These microorganisms require oxygen and a substrate on which to live. These two essentials are provided in a variety of designs, which broadly fall into different systems: fixed-film or suspended growth.

In fixed-film systems, such as trickling filter, rotating biological contactors, fluidized bed reactors or biological aerated filter, the biomass grows on media and the sewage passes over its surface. Oxygen is either supplied to the biota by spraying or trickling the wastewater over the filter materials, or the system is mechanically aerated.

In suspended growth systems, the biota is living on the sludge (called activated sludge). The activated sludge is mixed with the sewage and aerated in a tank or basin. This then passes to a clarifier, where the activated sludge can settle. Some of the sludge will be returned to the aeration tank; some will be disposed of or will undergo further treatment, depending on the local situation and regulations (Figure 9.3; see also sections 9.5.3 and 9.5.5).



Source: ETLog Health GmbH, Germany

Figure 9.3 Activated sludge wastewater-treatment system in a hospital in Sonla, Vietnam

Fixed-film systems are more able to cope with drastic changes in the amount of biological material, and can better adjust to specific wastewater characteristics. Fixed-film systems can provide higher removal rates for organic material and suspended solids, and are normally used for health-care wastewater treatment.

The removal of nitrogen is by biological oxidation from ammonia to nitrate. This is achieved by nitrification involving nitrifying bacteria such as *Nitrospira* sp. and *Nitrosomonas* sp. This is followed by reduction from nitrate to nitrogen gas (denitrification), which is released to the atmosphere. Denitrification requires anoxic conditions and might be carried out during the tertiary treatment in a sand filter or a reed bed. Nitrification and denitrification require carefully controlled conditions to encourage the appropriate microbiological communities to form.

Tertiary treatment

Tertiary treatment, also called “effluent polishing”, is the final step in a wastewater-treatment process before the effluent is discharged to the receiving environment. More than one tertiary treatment process can be used. If disinfection of the effluents as the final treatment step is required, then another step to remove suspended organic matter must be carried out before the disinfection.

Sand filtration, lagooning or planted horizontal gravel filters can be used to remove suspended organic matter. Constructed wetlands and engineered reed bed systems are another effective option.

Disinfection of wastewater from health-care establishments is often required, particularly if the wastewater is discharged into any waterbody used for recreational activities or used as a source of drinking-water (including aquifers). Disinfection of the wastewater is particularly important if it is discharged into coastal waters close to shellfish habitats, especially if the dietary habits of local people include eating raw shellfish.

9.5.2 Disinfection of wastewater

Chlorine-based disinfectants are traditionally used to disinfect health-care wastewater (tertiary treatment). The effectiveness of disinfection depends heavily on the quality of the water being treated (e.g. turbidity, pH), the type of disinfectant being used and the disinfectant dosage (concentration and time). Short contact times, low doses, high organic contents and high flows all reduce effective disinfection.

Chlorine disinfection will be effective only if the wastewater contains <10 mg/l of suspended organic matter, and turbid water will be treated less successfully, because solid matter can shield organisms. Chlorination of residual organic material may generate chlorinated organic compounds that may be carcinogenic and harmful to the environment. Therefore, disinfection by chlorine is only recommended if it can be ensured that the organic matter is below 10 mg/l.

Common methods and agents for disinfection include NaOCl (a commonly used disinfectant in health-care facilities) and chlorine dioxide (ClO₂). Chlorine dioxide can be considered as more efficient than NaOCl. Ultraviolet (UV) light is replacing chlorine due to the concerns about the impacts of chlorine; however, UV lamps need frequent maintenance and replacement, as well as a highly treated effluent. Ozone (O₃) is another option that can oxidize most organic material it comes in contact with, but requires highly skilled operators, and investment costs are comparatively high. However, ozone has advantages: it is a more effective disinfectant than chlorine, its action is less susceptible to changes in pH, and it can destroy specific chemical contaminants (such as some pharmaceuticals) in the wastewater.

9.5.3 Disposal of sludge

Onsite treatment of hospital sewage will produce a sludge that contains high concentrations of helminths and other pathogens, and should be treated before disposal. The most common treatment options include anaerobic digestion, aerobic digestion and composting.

Anaerobic thermophilic or mesophilic digestion is a complex bacterial process that is carried out in the absence of oxygen and is mainly used for large-scale plants. Composting or sludge de-watering and mineralization beds are most commonly used for onsite treatment in hospitals.

For composting, sludge is mixed with a carbon source such as sawdust, straw or wood chips. In the presence of oxygen, bacteria digest the sludge and the carbon source, and create heat that will pasteurize the sludge. In de-watering and mineralization beds, sludge is applied on a horizontal system – flow reed bed. One part of the water is absorbed by the reeds, which then transpire moisture into the air; the other part is returned to the wastewater-treatment plant through a drainage layer in the bottom of the reed bed. The de-watered sludge is incorporated into the microbiologically active top layers of the root zone of the reeds, where it is mineralized and turned into soil.

Figure 9.4 shows a simple schematic of a horizontal reed bed system.

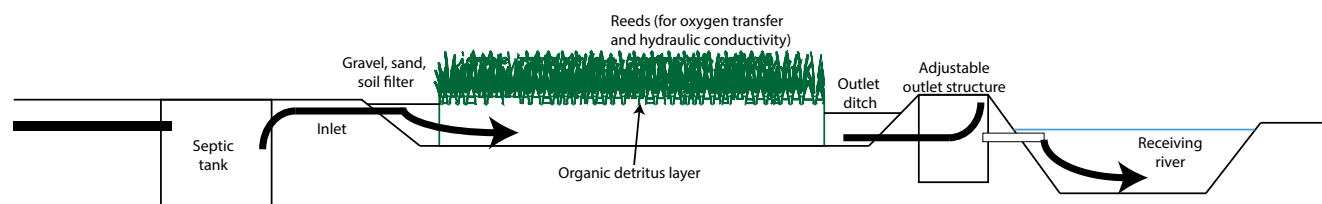

Figure 9.4 Horizontal reed bed system

9.5.4 Emerging technologies

Membrane biological reactors (MBR) combine activated sludge treatment with a membrane liquid–solid separation process. The membrane component uses low-pressure microfiltration or ultrafiltration membranes and eliminates the need for clarification and tertiary filtration. The membranes are typically immersed in the aeration tank (however, some applications use a separate membrane tank). MBR may play a key role in hospital wastewater treatment in the future, due to the high removal of bacteria possible and the potential to reduce antibiotic loads in discharged wastewater.

The cost of building and operating an MBR is usually higher than conventional wastewater treatment, as are the maintenance requirements. However, as the technology has become increasingly popular and gained wider acceptance, the life-cycle costs have been steadily decreasing. The method still requires skilled operators, but could be a solution for developed urban areas where the space requirement for a treatment plant is considered a limiting factor in hospitals.

In rural areas, alternative treatment systems such as reed beds, in combination with anaerobic pretreatment systems, are becoming more popular as an affordable and intermediate technology approach to secondary treatment. Anaerobic treatment is comparatively easy to operate and systems such as baffled up-flow reactors or anaerobic filters are increasingly being used. These systems can be combined with aerobic systems, such as planted horizontal gravel filters or reed beds, to achieve an often acceptable effluent that can be improved by applying sand filtration or aerobic polishing ponds.

9.5.5 Reuse of wastewater and sludge

Wastewater-treatment plants of health-care facilities often face operational problems, due to concerns about chemicals and pharmaceuticals in wastewater and the potential hygiene risks. The reuse of wastewater and sludge from hospitals with standard wastewater-treatment plants is generally not recommended and should only be done if knowledgeable staff and appropriate testing facilities are available.

While the reuse of treated sludge was common in the past, this practice has been criticized in recent times due to often high heavy metal concentrations and potential public health impacts. If sludge is reused for agricultural purposes, it should be tested to confirm that it does not contain more than one helminth egg per gram of total solids, and contains no more than 1000 faecal coliforms per gram of total solids (WHO, 2006). The sludge should be applied to fields in trenches and then immediately covered with soil.

The use of treated health-care wastewater should only be carried out if resources to meet environmental and safety standards can be assured and the relevant national or WHO guidelines on wastewaters can be followed. For unrestricted agricultural irrigation, there should be no more than one helminth egg per litre, and the number of *Escherichia coli* should be <1000 per 100 ml (WHO, 2006).

9.5.6 Offsite treatment and disposal in specialized facilities

Some categories of liquid hazardous health-care wastes, such as chemicals and cytotoxic wastes, should be treated and disposed of at offsite specialized treatment plants for hazardous waste in accordance with national standards or international conventions, such as the Basel and Stockholm conventions. Countries should plan hazardous waste-management systems that take into consideration the collection, transportation, treatment and disposal of some categories of hazardous liquid health-care wastes.

9.6 Operation and monitoring of sewerage systems

Problems in the management of wastewater in health-care facilities are mainly due to insufficient operation and maintenance. In most hospitals, the disposal of liquid hazardous waste via the sink is still practised daily. Leakages and blockages are likely to increase where sewers are insufficiently maintained. Commonly, the first indication of a problem is large wastewater losses between the entry points (sinks, toilets, drains) and an onsite treatment plant or tank or discharge point into a municipal sewerage system.

9.6.1 Operation and maintenance of wastewater systems

Typical problems in the operation of wastewater systems include:

- lack of awareness among senior staff at health-care facilities on wastewater problems;
- insufficient or non-functioning pretreatment and primary treatment systems, or no hazardous wastewater-management system;
- little or no programme of preventive maintenance;
- non-availability of basic tools to carry out maintenance;
- use of systems that are too complex to be operated by unskilled workers, or operational costs that are unbudgeted or too high to be affordable.

To ensure that wastewater-management responsibilities are taken seriously, a trained wastewater officer should be appointed. The starting point for developing a successful wastewater system is a wastewater audit, which would identify the expected wastewater streams from each medical and service area of the health-care facility, and provide data for pretreatment, collection and treatment arrangements for wastewater to be developed. A maintenance plan to cover both corrective and preventive maintenance should also be prepared. If an onsite treatment plant exists, it must be included in the operations and maintenance plans, and a budget allocated to sustain operations.

9.6.2 Monitoring of wastewater systems

The monitoring of the wastewater system includes two aspects: monitoring the sewerage system and monitoring effluent quality.

An often underestimated aspect in wastewater management is the loss of wastewater during collection and transport. Losses of 10–30% of the wastewater due to broken sewer pipes, non-watertight access holes and leakages at pipe connections are common. Installing a flow meter at the discharge point of the health-care facility is recommended for accurate monitoring. Maintenance and leakage problems can often be identified through regular (daily or weekly) comparison of water consumption and discharged wastewater quantities.

The most common parameters for monitoring the effluent quality are:

- temperature;
- pH;
- BOD₅ (a test to estimate the amount of oxygen consumed by biochemical oxidation of waste contaminants in a five-day period at 20 °C);

- chemical oxygen demand;
- nitrate;
- total phosphorus;
- total suspended solids;
- presence and concentration of *Escherichia coli*.

If an onsite treatment plant is operated, the inflow of wastewater and the outflowing treated effluent should be tested regularly to monitor how efficiently the treatment plant reduces the concentration of contaminants.

9.7 Minimum approach to wastewater management

9.7.1 Sanitation system

In many health-care facilities in developing countries, patients have no access to sewer-based sanitation facilities. In these places, human sanitation is often by pit latrines or something similar, and at worst by open defecation in the grounds of the health-care facility or nearby. Excreta collected from patients is usually disposed of via the same routes, creating a risk of infection to other people. This underlines the prime importance of providing access to adequate sanitation in every health-care facility. Sufficient toilets should be available; the recommended minimum is one toilet per 20 users for inpatient medical areas, and at least four toilets per outpatient location (one each for male and female staff, one for female patients, one for male patients) (WHO, 2008). Ideally, the toilets should be connected to a sewerage system. Where there are no sewerage systems, technically sound onsite sanitation should be provided. Guidance on this is available in a number of publications (e.g. Franceys, Pickford & Reed, 1992; Mara, 1996). These cover both simple techniques, such as the basic pit latrine, ventilated pit latrine and pour-flush latrine, and more advanced options, such as a septic tank with soakaway or an aqua-privy. Waterless systems and composting toilets are also now available.¹⁸

In temporary field hospitals during outbreaks of communicable diseases, other options such as chemical toilets may also be considered (Dunsmore, 1986). In addition, convenient washing facilities (with warm water and soap) should be available for patients, staff and visitors, to improve personal hand hygiene and so help limit the spread of infectious diseases within the health-care facility.

9.7.2 Minimal liquid hazardous waste-management system

The lower the standards of the wastewater treatment, the more important are the specific arrangements that are put in place for managing hazardous liquid waste. The following actions should be only carried out if no other way of hazardous waste disposal is available or during an emergency situation. The use of appropriate PPE is of utmost importance in all situations:

- Body fluids and the contents of suction systems from non-infectious patients from an operating theatre should be discharged via the drain by staff wearing PPE and with all possible further precautions to avoid fluid splashing.
- Stool, vomit and mucus from highly infectious patients (e.g. cholera patients) should be collected separately and thermally treated before disposal (e.g. by an autoclave reserved for waste treatment). Lime milk (calcium oxide) can be used during emergencies and if no appropriate autoclave or other disinfectant is available.
- Blood can be emptied into a septic or sewerage system if safety measures are followed (e.g. PPE and precautions against spatter). Other options for expired blood bags include disposal at a controlled land-disposal site, or treatment in a high-temperature incinerator (1100 °C) or in an autoclave that has a special liquid treatment programme cycle. If no other disposal option is available, expired blood bags may be isolated from patients and staff by placing unopened into a protected pit excavated within the grounds of the health-care facility or at

¹⁸ See, for example, http://en.wikipedia.org/wiki/Composting_toilet

another secure location.

- Solid health-care waste, especially solid hazardous waste (pharmaceuticals, chemicals), should not be mixed into wastewater.
- Liquid laboratory hazardous waste (colorants, formalin) should be collected separately. Adsorbent (e.g. sawdust) should be used for easier handling. The solid mass should be rendered immobile or encapsulated.
- Chlorine-based disinfectant should be diluted to reach a concentration of <0.5% active chlorine, and should be disposed of directly in a soakaway pit. Chlorine-based disinfectant should not be disposed of in a septic tank, because it will harm the biodegradation process.
- Liquid pharmaceuticals in vials (but not cytotoxic materials) can be crushed in a closed bucket, mixed with sawdust, and the solid mass incinerated or encapsulated.
- Glutaraldehyde should be stored after use and can be neutralized using glycine. Subsequently, it can be slowly disposed of via a soakaway pit.

Note that sludge and sewage from health-care facilities generated by a basic wastewater-management system should never be used for agricultural or aquaculture purposes. Effluents from the basic treatment should not be discharged into water bodies that are used nearby to irrigate fruit or vegetable crops or to produce drinking-water or for recreational purposes.

9.7.3 Basic wastewater-treatment systems

Figure 9.5 shows a schematic of a basic hospital wastewater-treatment system. This system consists of a primary and secondary treatment stage, which is considered as the minimum treatment for primary- and secondary-level rural hospitals.

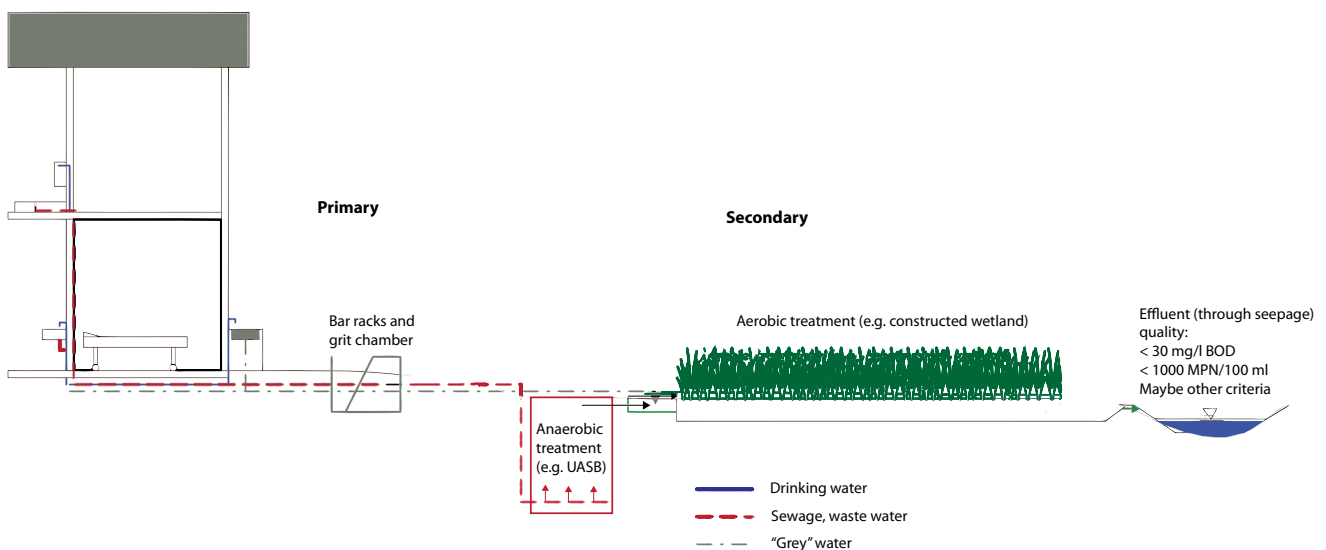

BOD, biological oxygen demand; MPN, most probable number; UASB, upflow anaerobic sludge blanket

Figure 9.5 Basic hospital wastewater-treatment system with two treatment stages

Decentralized septic tank system

The minimum treatment method for wastewater is the septic tank, a watertight receptacle for the separation of solid and liquid components of wastewater and for the digestion of organic matter in an anaerobic environment. A septic tank also takes on the functions of storing solids and allowing clarified liquid to outflow for further treatment or discharge.

A septic tank normally consists of two or more chambers and can be divided into the following zones (see Figure 9.6):

- horizontal: inflow, settlement and clarifying zone
- vertical: scum, detention and sludge zone.

The capacity of the septic tank should be equivalent to a total of two days' wastewater flow. If a two-chamber system is used, the first chamber should be two thirds of the total capacity. Access holes, inspection ports and ventilation should be installed in every chamber.

The wastewater enters the septic tank via a ventilated pipe. The heavier solid matter (sludge) falls to the bottom; fats and other lighter matter (scum) float to the surface. The effective settling and floating of solids is directly dependent upon the retention time within the tank, which should be not less than 24 hours. Anaerobic bacteria partly break down this solid matter.

Note that excessive build-up of sludge and scum reduces the capacity of the detention zone, resulting in discharge of suspended solids to the effluent disposal system. Solid matter (sludge, scum) from septic tanks must be removed when the chambers are half filled with sludge. If the level of solid matter cannot be controlled, it should ideally be removed once every two years.

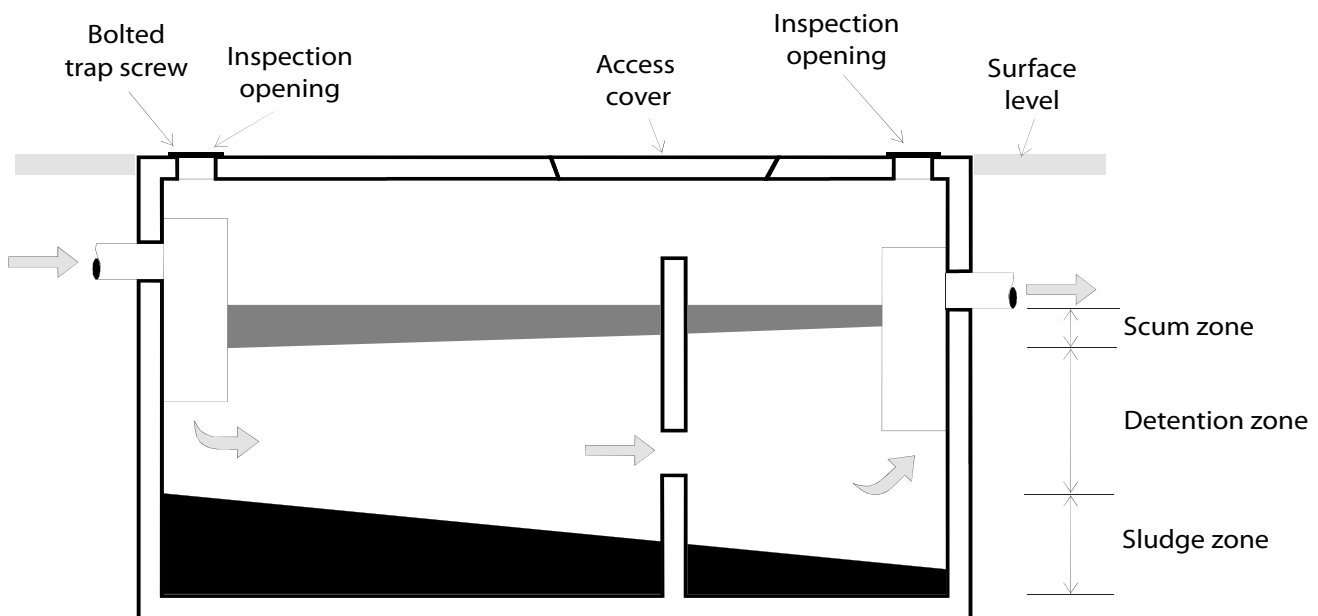

Source: South Australian Health Commission (1995)

Figure 9.6 Sample of a septic tank

Centralized, basic system

Centralized onsite treatment is recommended for health-care facilities to minimize maintenance, allow more advanced treatment, and improve the monitoring of the wastewater system. Basic centralized systems consist of primary treatment (sand catchment and screen to remove large particles) and an anaerobic secondary treatment system. Typical secondary treatment systems include:

- baffled flow reactors
- anaerobic filters
- Imhoff tank
- upflow anaerobic sludge blanket reactor.

Most of the systems allow for the harvesting of methane biogas if facilities are available. The effluents can be further treated. If this is not possible, a controlled discharge to soakaway pits or leachfields should be carried out.

Soakaway pits and leachfields

A soakaway pit should have one or more tanks, with the total volume equal to the wastewater-treatment plant. Effluents from the treatment plant are collected and allowed to infiltrate into the ground. The pit may be filled with stones, broken bricks or similar material or may be lined with open-jointed masonry. The top 0.5 m of the pit should be lined solidly, to provide firm support for a reinforced concrete cover. Planting trees adjacent to or over a soakaway can improve liquid removal through transpiration and increased soil permeability.

When larger amounts of wastewater need to be infiltrated (e.g. district hospitals), a leachfield is often a better solution. Leachfields consist of gravel-filled underground trenches, called leachlines, which allow the liquid effluent from the wastewater treatment to permeate into the ground. Open-jointed (stoneware) or perforated (polyvinyl chloride) pipes carry the liquid effluent into the leachfield. The leach trenches are usually 0.3–0.5 m wide and 0.6–1.0 m deep (from the top of the pipes). The trenches are laid with a 0.2–0.3% gradient of gravel (20–50 mm diameter), covered by a 0.3–0.5 m layer of soil.

Soakaway pits and leachfields present a threat of contamination to nearby wells. Both should be kept as far as practicable from shallow water wells and, where possible, they should be installed downstream of water abstraction sources. The distance between the bottom of the infiltration system and the groundwater table should be at least 1.5 m (more in coarse sands, gravels and fissured geological formations), and the system should be at least 30 m from any groundwater source (Harvey, 2002).

Lagooning system

In a region or an individual health-care facility that cannot afford sophisticated sewage-treatment plants, and where infiltration of the wastewater is not possible, a lagooning system is a basic solution for treating wastewater, if enough land is available (Figure 9.7). Lagooning systems are divided in facultative lagoons (oxygen is supplied primarily by algae) and aerated lagoons (oxygen is supplied by mechanical surface aeration). Mechanical aeration requires comparatively high operational costs (electricity); therefore, facultative lagoons are preferred.

Facultative means the presence of an anaerobic bottom region below an aerobic top layer. Facultative lagoons consist of a shallow basin in which settleable solids carried by the wastewater fall to the bottom and form a sludge layer that decomposes anaerobically. In the water column, the biodegradable organic materials held in suspension are degraded aerobically. Biodegradable organic carbon is converted by bacteria to biomass and carbon dioxide, and the latter is used photosynthetically by algae to form algal biomass and oxygen. The oxygen required for aerobic decomposition is supplied by bacteria.

Facultative lagoons can have the disadvantages of potentially generating pungent odours, variable effluent quality and a need for a large land surface area. Reed bed systems perform a similar function to lagoons and are regarded as a preferable option if resources exist to establish them.



Source: ETLog Health GmbH, Germany

Figure 9.7 Basic lagoon system at a hospital

9.8 Desirable improvements to the minimum approach

Enhancements to the minimum, initial approach include the following:

- Enforce liquid hazardous waste management; segregate and pretreat hazardous waste.
- Set up a maintenance system for the sewers and the septic tanks, provide maintenance equipment and clean septic tanks regularly.
- Set up a budget line to cover wastewater-treatment costs.
- Install grease traps for the kitchen wastewater and clean regularly.
- Replace any broken or non-watertight septic tanks and install sewer pipes with watertight joints.
- Connect any decentral treatment facilities to a central wastewater-treatment system.
- Ensure that chemical disinfection is only used when the suspended organic matter in wastewater is >10 mg/l.

Enhancements for intermediate approaches include the following:

- Upgrade lagoon systems to engineered reed bed systems.
- Regularly inspect the sewerage system and repair whenever necessary.
- Introduce tertiary treatment systems such as sand filtration or a subsurface horizontal gravel filter overplanted with vegetation to increase transpiration.
- Disinfect the wastewater by UV or change to chlorine dioxide or ozone (a combination of UV and ozone is most effective).
- Neutralize wastewater from laboratories before discharge into the sewerage system.
- Set up an “antibiotic committee” to minimize the usage of antibiotics within the health-care facility.

Key points to remember

- Untreated wastewater from health-care facilities may result in waterborne diseases and environmental problems, and can pollute drinking-water resources.
 - A separate financial budget, a routine maintenance system and a working management system for liquid hazardous waste are key elements in developing and operating an efficient wastewater-management system.
 - Basic systems can reduce the risk of waterborne diseases drastically if appropriately planned and implemented; more advanced systems reduce the risk further.
 - Pharmaceuticals and other hazardous liquid wastes in wastewater may form a serious future problem and must be carefully observed and minimized. This includes reducing to an absolute minimum the presence of antibiotics and pharmaceutical residues in wastewater.
 - Low-cost and low-maintenance systems, such as anaerobic treatment and reed bed systems, are available.
 - A good, well-maintained sewerage system is as important as an efficient wastewater-treatment plant.
-

9.9 References and further reading

References

Anonymous, ATV-DVWK-M 775 (German Water Association) (2001). *Abwasser aus Krankenhäusern und anderen medizinischen Einrichtungen* [Wastewater from hospitals and other healthcare facilities]. Hennef, Germany, German Water Association.

Crump JA, Luby SP, Mintz ED (2004). The global burden of typhoid fever. *Bulletin of the World Health Organization*, 82:346–353.

Dunsmore DJ (1986). *Safety measures for use in outbreaks of communicable diseases*. Geneva, World Health Organization.

Fewtrell L et al. (2007). *Water, sanitation and hygiene: quantifying the health impact at national and local levels in countries with incomplete water supply and sanitation coverage*. WHO Environmental Burden of Disease Series No. 15. Geneva, World Health Organization.

Franceys R, Pickford J, Reed R (1992). *A guide to the development of on-site sanitation*. Geneva, World Health Organization.

Harvey FE (2002). *Using stable isotopes in hydrologic investigations: examples from precipitation, surface water and groundwater studies in Nebraska*. Presentation at the University of Nebraska Water Research Forum – Celebrating, Reviewing and Planning Water Research in the New Millennium, 9 April 2002, Lincoln, Nebraska.

Mara D (1996). *Low-cost urban sanitation*. Chichester, United Kingdom, Wiley.

Novais C et al. (2005). Environmental contamination with vancomycin-resistant enterococci from hospital sewage in Portugal. *Applied and Environmental Microbiology*, 71(6):3364–3368.

Robert Koch Institute (2003). *Richtlinie für Krankenhaushygiene und Infektionsprävention*. Berlin, Robert Koch Institute.

South Australian Health Commission (1995). *Standard for the construction and installation and operation of septic tank systems in South Australia*. Adelaide, Environmental Health Branch of the Public and Environmental Health Service, South Australian Health Commission.

UNDP (United Nations Development Programme) (2010). *Suggested parameters for the analysis of wastewater from healthcare facilities*. New York, United Nations Development Programme Global Environment Facility Project on Healthcare Waste.

WHO (World Health Organization) (2006). *WHO guidelines for the safe use of wastewater, excreta and grey water. Vol. 1: Policy and regulatory aspects and Vol. 2: Wastewater use in agriculture.* Geneva, World Health Organization.

WHO (2008). *Essential environmental health standards in health care.* Geneva, World Health Organization.

WHO (2012). *The health and environment lexicon.* Geneva, World Health Organization.

Further reading

Gartiser S et al. (2000). *Environmentally sound disinfectants in hospital wastewater.* Berlin, UBA Forschungsbericht.

Kummerer K (2001). Drugs in the environment: emission of drugs, diagnostic aids and disinfectants into wastewater by hospitals in relation to other sources – a review. *Chemosphere*, 45:957–969.

Kummerer K et al. (1998). AOX-emissions from hospital into municipal wastewater. *Chemosphere*, 36:2437–2445.

Jolibois B, Guerbet M, Vassal S (2002). Glutaraldehyde in hospital wastewater. *Archives of Environmental Contamination and Toxicology*, 42(2):137–144.

Mara D, Cairncross S (1989). *Guidelines for the safe use of wastewater and excreta in agriculture and aquaculture.* Geneva, World Health Organization.

Pauwels B, Verstraete W (2006). The treatment of hospital wastewater: an appraisal. *Journal of Water & Health*, 4(4):405–416.

Silver Council (1997). *Code of management practice guide for diagnostic and industrial X-ray film processors.* Maryland, The Silver Council.

Rutala WA, Weber DJ (2008). *Guideline for disinfection and sterilization in healthcare facilities.* Atlanta, Centers for Disease Control and Prevention.

WHO (World Health Organization) (1989). *Health guidelines for the use of wastewater in agriculture and aquaculture.* WHO Technical Report Series, No. 778. Geneva, World Health Organization (http://www.who.int/water_sanitation_health/diseases/diseasefact/en/index.html).

10 Economics of health-care waste management

Key questions to answer

What are the economic benefits of introducing a safe system for the management of health-care waste?

How should costs be calculated?

How can the implementation of improved health-care waste-management methods be financed?

What costs are included for the treatment or disposal of health-care waste?

How can costs be reduced?

10.1 Guiding principles

Every health-care activity generates waste. If financial resources are not allocated insufficiently to manage health-care waste in the short term, there will be an even greater financial cost in the medium and long term on morbidity, mortality and environmental damage.

The management of health-care waste may vary in different parts of a health-care facility, but each part requires adequate financing to function well. Consequently, each health-care facility should be financially responsible for the safe management of any waste it generates. This is in accordance with the widely accepted “polluter pays” principle and the obligation of the duty of care. The World Health Organization’s (WHO’s) core principles for achieving safe and sustainable management of health-care waste require that all associated with financing and supporting health-care activities should provide for the costs of managing health-care waste (WHO, 2007). Therefore, governments are urged to allocate a budget to cover the costs of establishing and maintaining sound health-care waste-management systems. Donors, partners and other sources of external financing for health-care programmes should consider a provision in their programme assistance to cover the costs of managing wastes associated with their health-care interventions. Manufacturers also share a responsibility to take waste management into account in the development and sale of their medical products and services.

In addition, some basic principles should always be respected to minimize these costs:

- Waste minimization, segregation and recycling may reduce disposal costs if they lead to an overall reduction in waste-related expenditure. Producing less waste and segregation avoids unnecessary waste treatment.
- Forethought and careful design are needed to ensure that the elements of a health-care waste system are sized to have adequate capacity. The efficient handling, storage and treatment of wastes will avoid the need for subsequent costly modifications.
- Future trends in waste production and the likelihood of legislation becoming more stringent should be expected, and flexibility should be built into the waste-management system operated at a health-care facility.
- The amount of financial resources available to a health-care facility will influence the choice of waste-treatment system and the standards of operations that can be sustained.

10.2 Cost elements

The cost elements are classifications of items of expenditure associated with health-care waste management. The following sections describe cost elements at a health-care facility level (including onsite treatment), at a central facility level providing offsite treatment of waste for health-care facilities in a geographical region, and at the national level.

10.2.1 Costs at a health-care facility level

At the level of a health-care facility, the cost of health-care waste management comprises capital and operating costs. Capital costs pertain to one-time investments. Depending on the priorities and waste-management approach chosen by the facility, capital costs may include the following:

- site preparation, foundation, construction or renovation of the room or building where the treatment technology will be located (including electrical service, steam or water lines, lighting, ventilation);
- onsite waste-treatment technology and related accessories;
- shipment and customs fees;
- installation, start-up, testing and commissioning of the treatment technology;
- vehicles for transporting treated waste;
- construction of waste-storage areas;
- construction of trenches or pits for waste disposal.

Capital costs may also include the costs of waste-management equipment with a life span of more than a year, such as reusable hard plastic or metal bins, reusable sharps containers, waste-segregation posters, wheeled carts, large waste containers or skips (dumpsters), compactors and balers used for recycling.

Operating costs are recurrent costs incurred in the management of health-care waste. The main operating cost items are:

- labour: wages of the waste management coordinator, personnel responsible for waste collection, waste treatment technology operator, waste transport vehicle operator;
- consumable items related to waste management: plastic bags, disposable sharps boxes or containers, labels, cleaning supplies and disinfectants, personnel protective equipment (PPE) (e.g. gloves, face masks, aprons);
- fuel costs: diesel, kerosene, gas or other fuel used by the treatment system; transportation fuel;
- utilities: electricity, water, steam or other utilities used by the treatment system;
- maintenance, repair and replacement parts for all equipment and vehicles associated with waste management.

Although not all the costs listed above necessarily apply to all health-care facilities, the list provides a simple preliminary estimate of health-care waste management costs at the facility level. A system-costing approach captures additional costs, such as overhead costs, which may be more difficult to quantify initially. These additional cost items may include:

- administration;
- awareness raising and staff training;
- engineering and construction fees related to the treatment technology;
- regulatory fees: registrations, permits and licences associated with health-care waste generation, treatment and transport;
- renting or leasing of equipment;
- employee benefits such as health insurance and immunization of waste workers;
- sewage-treatment and landfill tipping fees.

For budgeting purposes, a contingency fee may be added to deal with equipment breakdown, spills, injuries and other accidents.

These costs are *internal* to the health-care facility (i.e. directly controlled by the decisions made by health-care managers). Waste-handling costs within health-care facilities are labour-intensive activities, and much of the direct, internal costs are for staff time. The costs of construction, operation and maintenance of an onsite system for managing health-care waste are part of the overall budget of a health-care facility. They should be covered by a specific allocation from the hospital or clinic budget.

An alternative to onsite treatment is to pay contractors who are prepared to invest in treatment and disposal equipment. Where a waste-treatment service is provided by contractors (service providers), the offsite transport, waste treatment and labour for waste treatment and final disposal are *external* (paid for through a negotiated fee) and hence beyond the management control of a health-care facility. Offsite expenditures tend to be dominated by transport, treatment and disposal costs.

10.2.2 Costs at a central treatment facility level

The cost elements for health-care waste management at a central treatment facility for a district, province or other geographical region depend on the scenarios for collection, transport, treatment and disposal of health-care waste. These costs also apply to cluster treatment arrangements, wherein a health-care facility serves as a hub for treatment of health-care waste from smaller hospitals, clinics and private practices in the surrounding area.

Collection and transport costs include the following cost items:

- containers, wheeled bins, trolleys
- transport vehicles
- fuel costs
- maintenance and repair
- labour.

Central treatment facilities may provide large containers (e.g. 600–800-litre carts) to the health-care facilities they serve. The filled containers, sized for the capacity of the transport vehicles, are picked up and replaced with clean ones during collection. The cost of transport vehicles depends on the load capacities required. The capacity, in turn, depends on the total volume of waste to be collected per day, the frequency of collection and the number of vehicles in operation. If health-care waste has to be stored in a vehicle beyond the storage time limits recommended in Chapter 7, the vehicle may need air-conditioning in warm climates. The operating costs of a transport vehicle are related to the distance travelled, speed, fuel efficiency of the vehicle, unit price of fuel, traffic, road conditions and maintenance requirements. Collection and transport costs can be reduced by good planning, optimum routing, scheduling and fleet management.

Centralized treatment takes advantage of the economies of scale. The costs of treatment and disposal are mainly determined by the type of treatment technology. For large-scale technologies, capital costs include site preparation, facility construction, cost of equipment and accessories, shipment, installation, regulatory approval and commissioning. In addition to the treatment unit itself, the health-care facility may also need pollution control equipment, waste-handling equipment, weighing scales, waste bin dumpers, shredders, compactors, roll-off containers, emergency equipment (fire extinguishers, eye wash, emergency showers, etc.) and ventilation. More advanced facilities may adopt a computerized waste-tracking system using bar codes, scanners or radiofrequency identification.

Operating costs are similar to those for an onsite treatment system (labour, consumables, energy, utilities, repair and maintenance, PPE, etc.) but also include management costs, administrative support, staff training, office expenses, property taxes, insurance, taxes on operation, and equipment depreciation.

The central treatment facility as a service provider may charge health-care facilities on a per-volume, per-weight or per-bed basis, with or without a maximum price limit. Other service providers may charge a predetermined exact price or fixed contract price. The rates of a privately operated commercial treatment facility include a profit mark-up.

10.2.3 Costs at a national level

Estimating costs at the national level is an essential aspect of developing a national implementation plan on health-care waste management. The costs related to national planning include staff time of ministry personnel, national consultation workshops, meetings with local governments and other ministries, researchers and consultants. The national plan could be broken down into several phases. The initial phase could entail upgrading existing onsite incinerators and landfills, and pilot projects to demonstrate non-incineration technologies both onsite and offsite. Treatment clusters and central treatment facilities could be developed further in a subsequent phase. Other costs on the national level are associated with regulatory development, national training and capacity building of ministry staff, awareness-raising campaigns, inspections and enforcement. Costing tools for estimating national budgets for health-care waste management are described in section 10.4.2.

10.3 Cost estimation

Estimating costs at a health-care facility begins with a waste assessment. The definitions and classification of waste in different countries affect the costs of waste-management strategies, infrastructure and disposal (Mühlich, Scherrer & Daschner, 2003). By knowing the types and amounts of waste generated daily, the locations within a health-care facility where waste is generated, and the frequency of collection (determined in part by the rate of generation at a particular location), one can estimate how many waste bins, plastic bags and sharps containers are needed each day, how many carts are required for the number of waste workers, how many gloves and other PPE are needed, and the size of the storage area. The daily amount of waste (current and projected for the lifetime of the treatment equipment) determines the capacity of the treatment unit required, given the number of shifts or hours of operation. After computing the quantities of equipment and the work hours, find out the unit prices of equipment (bins, bags, etc.) and wage rates for different job classifications (waste management coordinator, waste worker, etc.).

Capital or one-time costs can be computed by multiplying the quantity of a capital item by its corresponding unit price, which could include site preparation and installation for a large capital item. The following steps describe how to calculate capital costs on an annual equivalent basis:

1. Identify all the capital cost items of the waste-management system.
2. Determine the unit price of each item as quoted by a supplier.
3. Calculate the capital cost of the item by multiplying the required quantity of that item by its unit price.
4. Estimate n , the number of years of useful life that the item is expected to have from the time of purchase.
5. Specify a discount rate r (this could be the interest rate charged by a bank that provided the loan to purchase the equipment, a discount rate used by the Ministry of Finance, or simply an average bank deposit interest rate minus the inflation rate). A typical discount rate is 3%.
6. Use a standard annualization factor table to find the annualization factor for each capital item based on its expected equipment life and discount rate. The annualization factor can be calculated using the equation below:

$$r / [1 - (1 / (1+r)^n)]$$

where r is the discount rate and n is the number of years after year 0.

7. Calculate the annualized capital cost by multiplying the capital cost of the item by the annualization factor.

The total annualized capital cost is the sum of the annualized capital costs of all the capital items.

The daily operating cost is calculated as the quantity needed per day of a consumable item times its unit price. Total operating costs are calculated by adding up all the operating costs. The basic steps for calculating operating costs on an annual basis are:

1. Identify all recurrent cost items used in the waste-management system.
2. Estimate the quantities of each item needed for a whole year (e.g. safety boxes used up in one year, annual consumption of fuel or electricity related to waste treatment – or, in the case of labour – the number of days that a waste worker or waste supervisor works in a year).
3. Determine the unit cost of each item (e.g. the cost of a safety box, the cost per litre of fuel or per kWh of electricity, or the daily wage rate).
4. Calculate the annual operating cost by multiplying the quantity by the respective unit cost.
5. The total annual operating cost is the sum of the annual operating costs of all the recurrent cost items.

For treatment and disposal, the capital and operating costs depend on the treatment technology selected. In addition to the purchase cost of the equipment and the cost of installation and commissioning, treatment technology vendors can also provide estimates of operating cost per kilogram of waste treated. However, it is important to obtain and validate data on the amount of consumables, energy and utilities consumed per kilogram of waste treated, annual planned maintenance costs, and the unit prices of fuel, electricity, water and other utilities to ascertain the accuracy of operating costs provided by the vendors.

A similar process is used in estimating costs at a centralized treatment facility, except that the amount of waste to be treated per day is based on the waste generated by all the health-care facilities (current or projected) sending their wastes to the service provider. Moreover, the costs of collection and transport must also be calculated, based on the total volume of waste that needs to be collected per day, the frequency of collection, the number and size of the vehicles, the collection routes, cost of fuel, and so on.

Box 10.1 lists the elements that should be included in the cost assessment for a health-care waste-management system.

Box 10.1 Costs of construction and operation of a health-care waste-treatment plant (incinerator, autoclave, microwave, etc.)

	Direct operating costs
Site	
Cost of land	Manpower requirements (manager, operators, drivers)
Rights of way	Yellow bags with tags for infectious wastes
Site preparation and infrastructure	Black bags for non-risk waste
Provision of utilities to site	Sharps containers
Consultancy fees	Transportation costs
Environmental/waste-management consultant	Utilities (fuel, water, electricity)
Engineering	Chemicals (e.g. for flue-gas cleaning)
Architectural and planning	
Legal fees	

Box 10.1 *continued*

Construction costs	Indirect operating costs
Treatment plant building	Training
Waste storage room	Maintenance and parts replacement
Offices	Vehicle maintenance
Treatment plant (incinerator, autoclave, etc.)	Uniforms and safety equipment
Investment cost	Waste disposal cost after treatment
Freight and storage charges	Compliance monitoring of flue gas emissions or validation of disinfection levels
Waste transport costs	Project management and administrative costs for the organization responsible for the execution and long-term operation of the project
Waste collection trucks	
Bins/containers for transporting waste from hospitals to the treatment or disposal site	
Equipment costs	
Trolleys for collecting waste bags from wards	
Bag holders to be located at all sources of waste in hospitals	
Weighing machines for weighing waste bags	
Refrigerators for storage of waste if necessary	
Financing charges	
Interest	
Taxes	
Accounting and audit fees	

All health-care facilities need to establish accounting procedures to document the costs they incur in managing wastes. Accurate record keeping and cost analysis should be undertaken by a book-keeper or accountant, or by a specialist team in larger health-care facilities. Health-care waste costs should be separate budget lines in a health-care facility's financial accounts. This allows costs over different years to be compared. Financial data could also be used to identify inefficiencies and good management practices to control expenditures.

To ensure that a waste-management project is self-supporting, charges should reflect the full cost of operations, maintenance, debt amortization and interest. The inclusion of an amortization factor ensures the recovery of funds to repay the capital required to finance building construction and equipment replacements. If the charges levied do not cover all costs, the waste-management system will need to be subsidized, and a financing plan should be designed accordingly.

Table 10.1 provides the estimated ranges of capital and operating costs in 2003 for available treatment methods (Diaz & Savage, 2003). Small-scale incinerators with inadequate or no pollution control and capacities of 3–6 kg/hour have capital costs in the range of US\$ 800–6000 and operating costs of about US\$ 0.06–0.10 per kg.

Table 10.1 Estimated capital and operating costs for available treatment methods

Method	Capacity (kg/hour)	Capital cost (US\$ × 1000)	Operating cost (US\$/kg)
Autoclave	23–3600	30–1780	0.13–0.36
Chemical treatment	11–6800	20–890	0.15–2.2
Microwave	23–410	70–710	0.10–0.42
Incineration ^a	250–4000	120–6000	0.15–0.30

^a High technology incinerators with air pollution control
Source: Diaz & Savage (2003)

Table 10.2 Investment costs for incinerators in Indonesia

Capacity	Equipment description	Costs (US\$)
50 kg/hour	Manual loading, manual de-ashing, two-chamber system (temperature >1000 °C), without flue-gas cleaning	48,600
50 kg/hour	Manual loading, manual de-ashing, two-chamber system (temperature >1000 °C), including flue-gas cleaning: quenching and water jet scrubber	58,140
100 kg/hour	Manual loading, manual de-ashing, two-chamber system (temperature >1000 °C), without flue-gas cleaning	57,600
100 kg/hour	Manual loading, manual de-ashing, two-chamber system (temperature >1000 °C), including flue-gas cleaning: quenching and water jet scrubber	68,400

Source: J Emmanuel, personal communication, data compiled for the UNDP GEF Global Healthcare Waste Project (<http://www.gefmedwaste.org>)

Table 10.3 Investment costs for incinerators in Africa

Capacity	Equipment description	Cost (US\$)
50 kg/hour	Two-chamber system, diesel fired, manual loading, manual ash removal, no air-pollution control	71,000
50 kg/hour	Two-chamber system, oil fired, fully automatic burners, manual loading, manual ash removal, no air-pollution control	87,000
55 kg/hour	Two-chamber system, oil fired (temperature >1000 °C), manual ash removal, no flue-gas cleaning	93,000
75 kg/hour	Two-chamber system, diesel oil fired (temperature >1000 °C), manual loading, manual ash removal, no flue-gas cleaning	79,000
75 kg/hour	Two-chamber system, oil fired (temperature >1000 °C), manual loading, manual de-ashing, no flue-gas cleaning	104,000
75 kg/hour	Two-chamber system, oil fired, manual loading, manual ash removal, fully automatic burners, no air pollution control	109,000

Source: J Emmanuel, personal communication, data compiled for the UNDP GEF Global Healthcare Waste Project (<http://www.gefmedwaste.org>).

Table 10.4 Investment costs for large central incinerators that meet international standards

Capacity	Equipment description	Costs (US\$)
135 kg/hour	Two-chamber pyrolytic incinerator with gas burners, waste feed system, heat recovery boiler, induced draft, chimney, computer controls, emission monitoring (O ₂ , CO, SO ₂ , NOx, HCl and particulates) and wet scrubber flue-gas cleaning system	657 000
135 kg/hour	Two-chamber pyrolytic incinerator with gas burners, waste feed system, heat recovery boiler, induced draft, chimney, computer controls, emission monitoring (O ₂ , CO, SO ₂ , NOx, HCl and particulates) and catalytic gas cleaning system to reduce dioxins	1 250 000
300 kg/hour	Two-chamber pyrolytic incinerator with gas burners, waste feed system, heat recovery boiler, induced draft, chimney, computer controls, emission monitoring (O ₂ , CO, SO ₂ , NOx, HCl and particulates) and wet scrubber flue-gas cleaning system	952 000
300 kg/hour	Two-chamber pyrolytic incinerator with gas burners, waste feed system, heat recovery boiler, induced draft, chimney, computer controls, emission monitoring (O ₂ , CO, SO ₂ , NOx, HCl and particulates) and catalytic gas cleaning system to reduce dioxins	1 770 000
600 kg/hour	Two-chamber pyrolytic incinerator with gas burners, waste feed system, heat recovery boiler, induced draft, chimney, computer controls, emission monitoring (O ₂ , CO, SO ₂ , NOx, HCl and particulates) and wet scrubber flue-gas cleaning system	1 410 000
600 kg/hour	Two-chamber pyrolytic incinerator with gas burners, waste feed system, heat recovery boiler, induced draft, chimney, computer controls, emission monitoring (O ₂ , CO, SO ₂ , NOx, HCl and particulates) and catalytic gas cleaning system to reduce dioxins	2 560 000
800 kg/hour	Two-chamber pyrolytic incinerator with gas burners, waste feed system, heat recovery boiler, induced draft, chimney, computer controls, emission monitoring (O ₂ , CO, SO ₂ , NOx, HCl and particulates) and wet scrubber flue-gas cleaning system	1 620 000
800 kg/hour	Two-chamber pyrolytic incinerator with gas burners, waste feed system, heat recovery boiler, induced draft, chimney, computer controls, emission monitoring (O ₂ , CO, SO ₂ , NOx, HCl and particulates) and catalytic gas cleaning system to reduce dioxins	2 800 000
1350 kg/hour	Two-chamber pyrolytic incinerator with gas burners, waste feed system, heat recovery boiler, induced draft, chimney, computer controls, emission monitoring (O ₂ , CO, SO ₂ , NOx, HCl and particulates) and wet scrubber flue-gas cleaning system	2 220 000
1350 kg/hour	Two-chamber pyrolytic incinerator with gas burners, waste feed system, heat recovery boiler, induced draft, chimney, computer controls, emission monitoring (O ₂ , CO, SO ₂ , NOx, HCl and particulates) and catalytic gas cleaning system to reduce dioxins	3 520 000

Note: The differences between prices of incinerators of the same capacity can be found in the kind of flue-gas treatment. Costs do not include infrastructure for periodic stack testing of dioxins/furans and other pollutants.

Source: J Emmanuel, personal communication, data compiled for the UNDP GEF Global Healthcare Waste Project (<http://www.gefmedwaste.org>)

Table 10.5 Investment costs for alternative treatment solutions

Type	Country	Capacity	Equipment description	Cost (US\$)
Autoclave with reusable waste containers, and compactor (if used with needle destroyers) or shredder	UNDP GEF technologies developed in Tanzania	150–200 l	Horizontal single-walled autoclave using steam-flush pressure pulsing, built-in boiler with multiple energy options (electric, gas, other fuels), small compactor or shredder, autoclavable multiple-use containers	5000–15 000
Autoclave with integrated shredder	France	200 l	Shredder is inserted directly into treatment process (before treatment)	93 658

Table 10.5 *continued*

Type	Country	Capacity	Equipment description	Cost (US\$)
Autoclave and shredder	India and Germany	200 l	Horizontal autoclave, double-walled, with multiple vacuum, PLC control and high-torque shredder (Germany) for treated waste	86 000
Autoclave and shredder	USA	360 kg/h	Vacuum autoclave and high-torque shredder with ram assist and hydraulic waste bin tipper	313 000
Autoclave and shredder	Argentina	720 kg/h	Vacuum autoclave including waste bin lifter and carts with high-torque shredder	220 000
Autoclave and shredder	Argentina	1200 kg/h	Vacuum autoclave including waste bin lifter and carts with high-torque shredder	272 000
Autoclave	India	117 l	Pre-vacuum system, fully automatic	24 000
Autoclave	South Africa	135 l	Pre-vacuum system	27 516
Autoclave	South Africa	160 l	Pre-vacuum system	32 000
Autoclave	Spain	200 l	Fractionated system, installation and commissioning included	38 558
Autoclave	India	200 l	Horizontal autoclave, double-walled, multiple vacuum, PLC control	38 000
Autoclave	Netherlands	250 l	Pre- and post-vacuum, double-walled, fully automatic, steam supplied from electric steam generator, loading cart, cabinet, air compressor, printer	34 535
Autoclave	Netherlands	340 l	Pre and post-vacuum, double-walled, fully automatic, steam supplied from electric steam generator, loading cart, cabinet, air compressor, printer	55 530
Autoclave	India	340 l	Vacuum autoclave with automatic sliding door and PLC controls	31 000
Autoclave	Spain	400 l	Fractionated system, loading trolley, loading frame and air compressor included, installation and commissioning included	71 000
Autoclave	USA	450 kg/h	Vacuum horizontal autoclave including carts, boiler, water treatment system and PLC controls	222 000
Autoclave	Australia	550 l	Rectangular autoclave with pre-programmed cycles for solid and liquid health-care waste	83 000
Autoclave	USA	570 l	Vacuum autoclave with PLC controls, including bins and electric steam generator	112 000
Autoclave	Argentina	600 kg/h	Vacuum autoclave including waste bin lifter and carts	150 000
Microwave and shredder	Belgium	75 kg/h	Continuous microwave system with internal shredder, automatic operation	428 000
Microwave and shredder	Luxemburg	250 kg/h	Mobile system including shredder, special bins and bags needed, bins are included	630 249
Microwave and shredder	USA	818 kg/h	Automatically feeding, shredder is part of the system	566 805

Table 10.5 *continued*

Type	Country	Capacity	Equipment description	Cost (US\$)
Alkaline hydrolysis	USA	14 kg/h	Fully automated tissue digester for pathological, animal, specific cytotoxic, formaldehyde and glutaraldehyde wastes, with system accessories and remote monitoring	99 000
Alkaline hydrolysis	USA and Netherlands	15 kg/h	Caustic tissue digester for pathological (anatomical) waste, automatic controls, including steel basket	40 000

GEF, Global Environment Facility; PLC, programmable logic controls; UNDP, United Nations Development Programme; USA, United States of America
 Sources: J Emmanuel, personal communication, data compiled from 2007 to 2011 for the UNDP GEF Global Healthcare Waste Project (<http://www.gefmedwaste.org>); U Pieper, personal communication, data compiled in 2011 by ETLog Health GmbH

10.4 Cost and financing

For the establishment of a sustainable and good standard of health-care waste management, the availability of a distinct budget line for waste management in the yearly budget of a health-care facility is essential. This empowers managers in a health-care facility to operate, maintain and monitor the internal waste-management system efficiently. Absence of a dedicated budget will severely limit the improvements possible.

Before the construction of a new waste-treatment system for a health-care facility is envisaged, the possibility of working with other facilities should be considered to create a centralized or cluster treatment system, wherein waste from several health-care facilities is treated at a central location. The potential cost savings to health-care managers must be calculated carefully. Significant cost reductions in investment, maintenance and operation are possible when waste is treated in one large central plant.

When conducting a detailed comparative evaluation of the risks, benefits and costs of centralized or decentralized treatment methods, the decision to invest should include consideration of:

- the categories of waste
- generated waste amount
- availability of transport vehicles or transport companies
- infrastructure (roads, traffic)
- available treatment technology and capacity
- availability of staff with the required skills and expertise
- budget or costs.

The availability of local agents and technicians who can provide specialized maintenance, repair and spare parts should be considered when selecting treatment technologies. Without local technicians and spare parts, imported technologies may result in expensive shipping and long waiting times to receive spare parts and external assistance if the equipment breaks down or requires planned maintenance.

10.4.1 Methods of financing

Financing for waste operations may come from the private sector or from the government. The removal and disposal of health-care waste is a small component of the overall expenditure on health care. For publicly owned health-care facilities, a government may use general tax revenues or health insurance funds, if a national health insurance system exists, to pay all or part of the cost of the health-care system. For private health care, a government may

impose direct regulations, requiring the private facilities to implement their own waste-management systems, or compelling them to use designated publicly or privately operated waste-treatment and disposal facilities. Health-care waste-management costs in a private facility can be covered by inpatient and outpatient fees, private and government insurance payments, grants, donations, food sales and other revenue sources.

Privatization of waste management

In recent times, the privatization of waste-management operations has been increasingly adopted in a number of countries as an alternative method of financing various types of public works, including health care. Privatization may be a desirable option, particularly for treatment methods that require a high initial investment for construction and equipment. Possible financing structures vary. Three common types are public-private partnerships, central treatment solutions for waste “build-own-operate”, and build-operate-transfer. These arrangements involve privately financed schemes where a private company designs, builds, owns and operates treatment facilities, and provides collection and disposal services to government and private health-care facilities through negotiated long-term contracts.

One reason for privatizing waste management is the greater efficiency in the private sector than in the public sector. For example, the private sector has greater flexibility in purchasing and personnel policies, easier access to capital (investment) funds, and more rapid adaptation to new technologies and changing needs.

Another benefit of privatization is that organizations dedicated to providing waste-management operation and maintenance services often have more resources to maintain the expected standard of performance than a health-care facility.

However, a perceived disadvantage of privatization is the potential loss of overall control of waste-management operations by a health-care facility. The risk of a service failure is minimized where a facility has a well-functioning contract management team in place and has negotiated a contract with penalties for poor service.

The following issues should be included in a negotiated agreement between the private operator and the public agency:

- defined frequency and measures of quality and cleanliness to be achieved in each area of a health-care facility, together with an agreed monitoring system and penalties for substandard service;
- other measures to define the minimum level of service, especially with regard to reliability, safety, public health risks and possible future expansion of the service if the health-care facility increases its activities;
- future increases in costs resulting from factors that cannot be fully assessed at the outset and a formula in the contract to calculate future inflation in costs;
- environmental concerns;
- future transfer of ownership of the facilities;
- regular inspection and regulatory control;
- exploration of the feasibility of cooperation between two or more health-care facilities, as another means of minimizing total costs;
- a break clause in the contract to permit periodic reviews of the waste service and other revisions to the contract.

10.4.2 Costing tools

The total cost of setting up a health-care waste-management system requires a realistic examination of the likely costs of operations in each area to reach an accurate financial estimate. An economic analysis at a national level could be used to determine an optimal mix of centralized and decentralized treatment approaches. WHO has developed two costing tools – the cost-analysis tool (CAT) and the expanded cost-analysis tool (ECAT) – to assist countries in estimating the total costs of health-care waste management at the national, regional and facility levels.

Both costing tools require some basic data, such as the amounts of waste generated and the number of facilities, and then apply assumptions to compute average annualized capital and operating costs for health-care facilities of different bed sizes, as well as costs on the national level. Users can input specific values (such as the unit price of a wheeled cart or the wage rate) or use the default values in the tool. CAT deals only with onsite treatment. ECAT expands on CAT by differentiating between low-, middle- and high-income countries; providing more size categories for health-care facilities (based on number of beds); presenting more treatment options (autoclaves and autoclave shredders, incinerators, microwave treatment, and hybrid steam treatment systems); and allowing the user to define a mix of centralized and decentralized treatment. These tools are described in Box 10.2.

The “equivalent annual cost method” is used in both costing tools. The tools compute a total annualized cost, which is the total annual operating cost plus the total annualized capital cost. The annual operating cost includes cost of labour, fuel, safety boxes, plastic bags, maintenance, and so on. The total annualized capital cost is the sum of the amortized costs of each capital item (e.g. autoclave, storage area, reusable bins), taking into consideration their equipment life spans. The standard equation for annualized capital cost (ACC) is:

$$ACC = \frac{CC(r)}{1 - \frac{1}{(1+r)^n}}$$

where CC is the capital cost of an equipment, r is the interest rate (or discount rate), and n is the estimated lifespan of the equipment.

The total annualized cost or equivalent annual cost method is a recommended technique for comparative economic analysis of two or more treatment options. Other methods include net present value and return on investment.

Box 10.2 Tools for estimating total costs of health-care waste management

Cost-analysis tool

The basic assumption of the cost-analysis tool (CAT) is that it is possible to calculate initial cost estimations using a few basic indicators (Tool A1). These first results should then be specified by performing a simplified system costing calculation (Tools B1–B4). Calculations can then be improved or further refined as and when data about the system are gathered in the future. The aim of this tool is to help calculate annual budgets that need to be allocated for health-care waste management.

<http://www.healthcarewaste.org/resources/documents/>

Expanded cost-analysis tool

The expanded cost-analysis tool (ECAT) is a modified version of CAT and provides more options and approaches than CAT. It was created to help the user to estimate costs related to health-care waste management at the health-care facility, central treatment facility, health-care facility cluster, or national levels.

The ECAT allows one or more treatment approaches:

- treatment of waste onsite at health-care facilities (decentralized or onsite treatment);
- treatment of waste at central facilities or large hospitals to which a cluster of health-care facilities send their waste (centralized or cluster treatment);
- a combination of the above.

The ECAT also allows four treatment technology options for onsite treatment:

- autoclave and sharps pit
- incinerator and lined ash pit
- needle remover, autoclave and small pit
- needle remover, incinerator and lined ash pit.

<http://www.healthcarewaste.org/en/documents.html?id=218>

Source: WHO (2007)

10.4.3 Pricing models for a treatment provider

Pricing models describe ways in which prices can be set within a market for particular goods or services. The most effective and fair pricing model for calculating the treatment costs of health-care waste depends on a range of factors such as political goals, population awareness, control mechanisms and legal regulations, as well as waste-treatment capacities, waste kinds, waste quantities and transport distances. The overall targets of pricing models are to:

- improve waste disposal or treatment according to legal regulations
- incentivize waste generators to minimize waste
- prevent illegal dumping
- improve waste segregation
- set up a fair and cost-covering system for both health-care facilities and disposal companies.

In general, two pricing models can be differentiated: fixed pricing and variable pricing. The benefits and drawbacks are listed in Tables 10.6 and 10.7.

The fixed and variable pricing models can be combined.

Table 10.6 Positive and negative effects of fixed pricing

Description	Positive effects	Negative effects
Lump sum: "all-inclusive" price for the waste treatment/disposal	Transparent and easy to calculate	No incentive for proper segregation Shady pricing strategy for the authorities Inflexible in case of structural changes (e.g. increase in beds)
Price per hospital bed: fixed price per number of beds in the health-care facility	Transparent and easy to calculate	No incentive for proper segregation Inflexible in case of short-term changes, etc.

Table 10.7 Positive and negative effects of variable pricing

Description	Positive effects	Negative effects
Price per kilogram: price in accordance with the weight of the waste	Polluter pays principle is followed 100% Incentive for proper segregation and waste reduction (cost saving) Cost savings can be achieved by good waste management Record keeping of the generated waste Transparent and fair system	Higher effort because the waste has to be weighed Risk that hazardous waste will be disposed of as non-risk waste
Price according to the number of patient treatment days: a fixed sum per inpatient treatment day and/or a fixed sum per outpatient	Easy to calculate Flexible system in case of fluctuating patient rates	No incentive for proper segregation Occupation rate, number of patients, etc., must be transparent and reliable
Price per bag: price in accordance with the number of bags Price per pick-up: price in accordance with the number of pick-ups of the waste	Easy to control by the hospitals and the contractor Incentive for proper segregation and waste reduction (cost saving) Record keeping by the disposal company	Price per bag: risk that hazardous waste will be disposed of as non-risk waste risk of overstuffing bags and containers Pick-up: risk that the maximum storage time and capacity will be exceeded external company picks up more often than required, resulting in excess charges

10.5 Recommendations for cost reductions

When wastes are segregated – for example, between infectious and non-infectious waste types – it can lead to sizeable reductions in treatment and disposal costs. Segregation enables smaller and potentially more costly waste streams to be treated separately from less costly bulk quantities of non-hazardous general waste. A reduction in the risk of secondary infections from poorly managed waste also reduces the number and overall cost of additional health-care interventions.

Cost reductions can be achieved by taking particular measures at different stages in the management of wastes:

- onsite management;
- substitution of disposable medical care items by recyclable items;
- adequate segregation of waste to avoid costly or inadequate treatment of waste that does not require it; improved waste identification to simplify segregation, treatment and recycling;
- comprehensive planning;
- development and implementation of a comprehensive health-care waste-management strategy, within the framework of the hospital waste-management plan;
- planning collection and transport to ensure that all operations are safe and cost efficient;
- possible cooperative use of regional incineration facilities, including private-sector facilities, where appropriate;
- establishment of a wastewater disposal plan.

Documentation

Waste management and cost documentation involve accurate estimation of costs to facilitate identifying priorities for cost reduction, and to monitor progress towards achieving performance objectives. The following considerations apply:

- choice of adequate treatment or disposal method
- selection of a treatment and disposal option that is appropriate for the waste type and local circumstances
- use of treatment equipment designed to process waste and with sufficient capacity to operate economically
- measures at personnel level
- establishment of training programmes for workers to improve their skills and quality of work
- protection of workers against occupational risks.

10.6 Minimum approach to health-care waste management costing

To obtain a sustainable financing system for managing health-care waste, the costs should be included in the health-care facility's annual financial budget planning as an indicated budget line, so that expenditures can be monitored and tracked. The budget should at least cover the following costs:

- sharps containers or safety boxes
- bins or bags in different colours to segregate hazardous and general health-care waste
- waste handling, PPE and cleaning supplies
- treatment and disposal
- repair and maintenance
- personnel (waste handlers).

10.7 Desirable improvements to the minimum approach

Improvements to the minimum approach that can be included in the budget are:

- information and education materials (e.g. posters and labels)
- transport trolleys
- personnel cost (health-care waste officer, waste treatment supervisor, staff immunization, etc.)
- training in health-care waste management
- improved storage infrastructure (storage bins and compounds, etc.)
- upgraded treatment units to modern, environmentally friendly treatment technology
- improved transport vehicle
- final waste disposal in a sanitary landfill.

Key points to remember

Inadequate financing of health-care waste management has a large financial cost in the long term on morbidity, mortality and environmental damage.

Providing for the costs of managing health-care waste is a core principle for achieving safe and sustainable management of health-care waste.

Different cost elements should be considered at a health-care facility level, a central treatment facility level and the national level.

Cost-estimation methods, costing tools, and data on capital and operating costs of different treatment options are useful in developing a budget for health-care waste management.

Managers should be aware of the effects of different pricing models, financing options and cost reduction measures.

10.8 References and further reading

References

Diaz LF, Savage GM (2003). *Risks and costs associated with the management of infectious wastes*. Geneva, World Health Organization.

Mühlich M, Scherrer M, Daschner FD (2003). Comparison of infectious waste management in European hospitals. *Journal of Hospital Infection*, 55:260–268.

WHO (World Health Organization) (2007). *WHO core principles for achieving safe and sustainable management of health-care waste*. Geneva, World Health Organization (http://www.who.int/water_sanitation_health/medicalwaste/hcwprinciples/en/index.html).

Further reading

Emmanuel J, Hrdinka Č, Gluszyński P (2004). *Non-incineration medical waste treatment technologies in Europe*. Prague, Health Care Without Harm Europe.

11

Health and safety practices for health-care personnel and waste workers

Key questions to answer

How hazardous is health-care waste?

Who is at risk?

What are the hazards?

What are the procedures that should be set up to reduce the risk of accidents?

What equipment and supplies are needed to protect workers?

How can exposure be prevented or limited?

What education is needed for those who are at risk?

11.1 Guiding principles

The occupational safety of health-care personnel and workers handling waste is often overlooked. The purpose of this chapter is to explain the hazards and infection risks they may encounter, and the prevention and control of exposure to them. Health-care waste-management policies or plans should include arrangement for the continuous monitoring of workers' health and safety. This is to ensure that correct handling, treatment, storage and disposal procedures are being followed. Sensible occupational health and safety measures include the following:

- develop a standardized set of management rules and operating procedures for health-care waste;
- inform and train waste workers so that they perform their duties properly and safely;
- involve waste workers in the identification of hazards and recommendations for prevention and control;
- provide equipment and clothing for personal protection;
- establish an occupational health programme that includes information, training and medical measures when necessary, such as immunization, post-exposure prophylactic treatment and regular medical surveillance.

Standardized and written health-care waste-management procedures, when respected by personnel and monitored by the hospital management, can dramatically reduce the risk of accidents. Hospital staff should be taught and kept informed about the health-care waste-management system and procedures that are in place.

Workers at risk from infection and injury include health-care providers, hospital cleaners, maintenance workers, operators of waste-treatment equipment, and all personnel involved in waste handling and disposal within and outside health-care facilities.

Training in health and safety is intended to ensure that workers know of and understand the potential risks associated with health-care waste, and the rules and procedures they are required to respect for its safe management. They should be informed on the importance of consistent use of personal protective equipment (PPE) and should be aware of where to obtain post-exposure follow-up in case of a needle-stick injury or other blood exposure.

Health-care personnel should be trained for emergency response if injured by a waste item, and the necessary equipment should be readily available at all times. Written procedures for the different types of emergencies should be drawn up. For dangerous spills of hazardous chemicals or highly infectious materials, the clean-up operation

should be carried out by designated personnel specially trained for the purpose.

To limit the risks, the hospital management must set up management rules and operating procedures for health-care waste and establish standardized emergency procedures. It is the responsibility of everybody involved in handling waste to know the emergency procedures and to act accordingly. One person should be designated as responsible for the handling of emergencies, including coordination of actions, reporting to managers and regulators, and liaising with emergency services. A deputy should be appointed to act in case of absence.

11.2 Occupational health risks

Health-care waste handlers are at greatest risk from infectious hazards, especially sharps that are not disposed of into puncture-resistant containers. The risk of acquiring a secondary infection following needle-stick injury from a contaminated sharp depends on the amount of the contamination and nature of the infection from the source patient. The risk of infection with hepatitis B is more than 10 times greater than for hepatitis C, and up to 100 times greater than for human immunodeficiency virus (HIV) (Table 11.1).

Table 11.1 Risk of transmission of infection following occupational exposure

Bloodborne virus	Risk of transmission of infection
HIV	0.3% ^{a-c}
Hepatitis B	18–30% ^d
Hepatitis C	1.8% ^e

^a Post-exposure prophylaxis can reduce the risk of HIV transmission by 80% (Cardo et al., 1997)

^b WHO & ILO (2007)

^c Bell (1997)

^d Prüss-Ustün et al. (2005)

^e Puro et al. (2010)

Actual cases of non-sharps waste being demonstrated to cause an infection in health-care staff and waste workers are rarely documented. However, it is known that waste handlers were infected by tuberculosis (TB) at a medical waste-processing facility in Morton, Washington, in the United States of America, as a result of exposure to health-care waste. The National Institute for Occupational Safety and Health evaluated the response to an outbreak of TB among the employees of the waste-processing facility. In October 1998, the *Health hazard evaluation report* identified several factors present in the facility that could have contributed to employee exposures to pathogens potentially present in the waste (Weber, Boudreau & Mortimer, 1998).

11.2.1 Health hazards

Other hazards to health-care waste workers include chemical exposures such as chemotherapeutic drugs, disinfectants and sterilants; physical hazards such as ionizing radiation; and ergonomic hazards such as manual lifting and transporting of heavy waste loads (Table 11.2).

Table 11.2 Hazards to health-care waste workers

Hazards	Health effects	Control measures
Sharps injuries and resulting exposure to bloodborne pathogens	Infections with hepatitis B or C, HIV, malaria or other bloodborne infections (Prüss-Ustün, Rapiti & Hutin, 2005)	Immunization against hepatitis B virus (WHO, 2009a) Appropriate disposal of sharps at site of use into a puncture-resistant container without recapping (Hutin et al., 2003; WHO, 2010) Use of engineered needles that automatically retract, blunt resheath, or disable the sharp (CDC, 1997; Lamontagne et al., 2007)
Other biological hazards	SARS (WHO, 2007a, 2009b) Tuberculosis Influenza	Exhaust ventilation (natural or mechanical (WHO, 2009c, 2009d) Standard precautions (WHO, 2007b) Respiratory protection with N95, FFP3 respirators for high-risk cough-inducing procedures (Jefferson et al., 2008; WHO, 2009c) Autoclaving laboratory waste in the laboratory before disposal (Weber, Boudreau & Mortimer, 1998)
Chemicals Chlorine disinfectants (sodium hypochlorite)	Skin and respiratory sensitization (International Programme on Chemical Safety, 1999; Zock et al., 2007) Eye and skin irritation, weakness, exhaustion, drowsiness, dizziness, numbness and nausea	Substitute soap and water for cleaning chemicals Avoid soaking of sharps in chlorine when they will receive autoclaving or incineration before disposal Dilute chemicals appropriately according to manufacturer for less toxic exposure (Zock, Vizcaya & Le Moual, 2010)
High-level disinfectant glutaraldehyde	Irritation of the eyes, nose and throat Skin sensitization Occupational asthma where the symptoms in affected individuals include chest tightness and difficulty in breathing (Mirabelli et al., 2007)	Substitute steam sterilization except for pressure-sensitive instruments (Harrison, 2000; Pechter et al., 2005) Ensure appropriate dilution and use in closed, ventilated system
Sterilants: ethylene oxide (International Programme in Chemical Safety, 2003)	Eye and skin irritation, difficulty breathing, nausea, vomiting, and neurological problems such as headache and dizziness Reproductive hazard, linked to nerve and genetic damage, spontaneous abortion and muscle weakness Carcinogen (IARC, 1999)	Substitute steam sterilization for ethylene oxide except for pressure-sensitive instruments (EPA, 2002) Use only in a closed and ventilated system
Heavy lifting Handling heavy loads over long periods	Back injuries and musculoskeletal disorders (Schneider & Irastorza, 2010) Degenerative diseases of the lumbar spine	Reduce mass of objects or number of loads carried per day (Nelson, 2003) Use waste carts with wheels, automated waste transfer from cart to truck and treatment Use lifts and pulleys to assist in transferring loads
Ionizing radiation	Irreversible damage of cells, anaemia, leukaemia, lung cancer from inhalation (Niu, Deboodt & Zeeb, 2010)	Safe waste management, in full compliance with all relevant regulations, must be considered and planned for at the early stages of any projects involving radioactive materials It should be established from the outset that the waste can be properly handled, treated and ultimately disposed of See International Atomic Energy Agency for national regulatory standards and safety guidance (IAEA, 1995)

HIV, human immunodeficiency virus; SARS, severe acute respiratory syndrome

11.2.2 Cytotoxic safety

The senior pharmacist at a health-care facility should be made responsible for ensuring the safe use of cytotoxic drugs. Large oncological hospitals may appoint a full-time genotoxic safety officer, who should also supervise the safe management of cytotoxic waste. The following measures are important to minimize exposure:

- written procedures that specify safe working methods for each process;
- data sheets, based on the suppliers' specifications, to provide information on potential hazards and their minimization;
- established procedure for emergency response in case of spillage or other occupational accident;
- appropriate education and training for all personnel involved in the handling of cytotoxic drugs.

These measures are unlikely to be needed in rural or smaller district hospitals that do not typically use genotoxic products, either cytotoxic or radioactive. In countries where the safe use of cytotoxic and radioactive materials is difficult to ensure, it may be advisable to limit the use of those substances to a small number of specialized (e.g. oncological) hospitals that are better able to implement appropriate safety measures. In hospitals that do use cytotoxic products, specific guidelines on their safe handling should be established for the protection of personnel. These guidelines should include rules on the following waste-handling procedures:

- separate collection of waste in leak-proof bags or containers and labelling for identification;
- return of outdated drugs to suppliers;
- safe separate storage of genotoxic waste away from other health-care waste;
- arrangements for the disposal of contaminated material, the decontamination of reusable equipment and the clean-up of spillages;
- arrangements for the treatment of infectious waste contaminated with cytotoxic products, including excreta from patients, disposable linen and absorbent material for incontinent patients.

More information on the treatment and disposal of cytotoxic waste is given in section 8.11.4. Specific procedures to follow in case of spillage and decontamination of mutagenic and carcinogenic products are presented in Annex 5. Minimal protective measures for all waste workers who handle cytotoxic waste should include protective clothing, gloves (chemical barrier), goggles and face masks.

Hospital staff should ensure that the families of patients undergoing chemotherapy at home are aware of the risks and know how they can be minimized or avoided.

11.3 Exposure prevention and control

All health-care workers are at risk of exposure to blood at work and should be immunized against the hepatitis B virus before commencing employment.

A proper and safe segregation system for hazardous waste is the key to occupational safety and environmental sound handling. Implementing a proper segregation system must be accompanied by safe and standardized handling procedures.

11.3.1 Hierarchy of controls (applied to bloodborne pathogens)

Methods to control occupational hazards have traditionally been discussed in terms of hierarchy and presented in order of priority for their effectiveness in preventing exposure to the hazard or preventing injury resulting from exposure to the hazard. Box 11.1 shows how to apply the hierarchy of controls framework to bloodborne pathogen hazards.

Box 11.1 Controls framework

Elimination of hazard – complete removal of a hazard from the work area. Elimination is the method preferred in controlling hazards and should be selected whenever possible.

Examples include removing sharps and needles and eliminating all unnecessary injections. Jet injectors may substitute for syringes and needles. All unnecessary sharps, such as towel clips, should also be eliminated, and needleless systems should be used.

Engineering controls – controls that isolate or remove a hazard from a workplace.

Examples include sharps disposal containers (also known as safety boxes) and needles that retract, sheathe or blunt immediately after use (also known as safer needle devices or sharps with engineered injury-prevention features).

Administrative controls – policies to limit exposure to a hazard (e.g. universal precautions).

Examples include allocation of resources demonstrating a commitment to staff safety, an infection-control committee, an exposure control plan, replacement of all unsafe devices and consistent training on the use of safe devices.

Work practice controls – controls that reduce exposure to occupational hazards through the behaviour of workers.

Examples include no needle recapping, placing sharps containers at eye level and at arm's reach, emptying sharps containers before they are full, and arranging for the safe handling and disposal of sharps devices before beginning a procedure.

Personal protective equipment (PPE) – barriers and filters between the worker and the hazard.

Examples include eye goggles, gloves, masks and gowns.

See also http://www.who.int/hiv/pub/prev_care/ilowhoguidelines.pdf

Source: ILO & WHO (2005)

11.3.2 Dealing with spillages

Spillages require clean-up of the area contaminated by the spilt waste. For spillages of highly infectious material, it is important to determine the type of infectious agent, because immediate evacuation of the area may be necessary in some cases. In general, the most hazardous spillages occur in laboratories rather than in medical care departments.

Procedures for dealing with spillages should specify safe handling operations and appropriate protective clothing. An example of such a procedure is provided in Box 11.2. Appropriate equipment for collecting the waste and new containers should be available, as should means for disinfection. Table 11.3 provides a typical list of required items.

In case of skin and eye contact with hazardous substances, there should be immediate decontamination. An exposed person should be removed from the area of the incident for decontamination, generally with copious amounts of water. Special attention should be paid to the eyes and any open wounds. In case of eye contact with corrosive chemicals, the eyes should be irrigated continuously with clean water for 10–30 minutes; the entire face should be washed in a basin, with the eyes being continuously opened and closed.

Table 11.3 Example of a list of items for spillage cleaning

Action	Tools or items
Approaching the spillage	Protective equipment (to secure the area)
Containing the spillage	Absorbent material (e.g. absorbent paper, towels, gauze pads)
Neutralizing or disinfecting the spillage (if necessary)	For infectious material: disinfectant ^a For acids: sodium carbonate, calcium carbonate or other base For bases: citric acid powder or other acid For cytotoxic material: special chemical degradation substances
Collecting the spillage	For liquids: absorbent paper, gauze pads, wood shavings, calcium bentonite, diatomaceous earth For solids: forceps, broom, dustpan or shovel For mercury: mercury sponge or vacuum pump
Organizing containment for disposal	Plastic bag (red, yellow, or brown, as appropriate), sharps container
Decontaminating or disinfecting the area	For infectious material: disinfectants ^a For hazardous chemicals: suitable solvent or water
Documenting the spillage	Report of incident to the superior

^a Such as bleaching powder, which is a mixture of calcium hydroxide, calcium chloride and sodium hypochlorite, used in the powder form or in solution of varying dilution (1:1 to 1:100) depending on the nature of the spilled material
Source: adapted from Reinhardt & Gordon (1991)

Box 11.2 Example of general procedure for dealing with spillages

- **Evacuate** the contaminated area.
- **Decontaminate** the eyes and skin of exposed personnel immediately.
- **Inform** the designated person (usually the waste-management officer or infection-control officer), who should coordinate the necessary actions.
- Determine the **nature** of the spill.
- **Evacuate** all the people not involved in cleaning up if the spillage involves a particularly hazardous substance.
- Provide **first aid** and medical care to injured individuals.
- **Secure** the area to prevent exposure of additional individuals.
- Provide adequate **protective clothing** to personnel involved in cleaning up.
- **Limit** the spread of the spill.
- **Neutralize or disinfect** the spilled or contaminated material, if indicated.
- **Collect** all spilled and contaminated material. (**Sharps should never be picked up by hand**; brushes and pans or other suitable tools should be used.) Spilled material and disposable contaminated items used for cleaning should be placed in the appropriate waste bags or containers.
- **Decontaminate or disinfect** the area, wiping up with absorbent cloth. The cloth (or other absorbent material) should never be turned during this process, because this will spread the contamination. The decontamination should be carried out by working from the least to the most contaminated part, with a change of cloth at each stage. Dry cloths should be used in the case of liquid spillage; for spillages of solids, cloth impregnated with water (acidic, basic or neutral, as appropriate) should be used.
- **Rinse** the area, and wipe dry with absorbent cloth.
- **Decontaminate or disinfect** any tools that were used.
- **Remove** protective clothing and decontaminate or disinfect it, if necessary.
- **Seek medical attention** if exposure to hazardous material has occurred during the operation.
- **Report** the incident and document the response.

Source: adapted from Reinhardt & Gordon (1991)

11.3.3 Reporting accidents and incidents

All waste-management staff should be trained in emergency response and made aware of the correct procedure for prompt reporting. Accidents or incidents, including near misses, spillages, damaged containers, inappropriate segregation and any incidents involving sharps, should be reported to the waste-management officer (if waste is involved) or to another designated person. The report should include details of:

- the nature of the accident or incident
- the place and time of the accident or incident
- the staff who were directly involved
- any other relevant circumstances.

The cause of the accident or incident should be investigated by the waste-management officer (in case of waste) or other responsible officer, who should also take action to prevent recurrence. The records of the investigation and subsequent remedial measures should be kept.

11.3.4 Protective equipment

The most effective PPE in reducing risk of injury are gloves to protect from exposure to blood, other potentially infectious materials and chemicals; particulate masks (respirators) to protect from respiratory infections hazards and particulates from burning waste; and boots for waste handlers to protect from sharps injuries to the foot. Availability and access to soap and water, and alcohol hand rub, for hand hygiene are also important to maintain cleanliness and inhibit the transfer of infection via dirty hands.

The type of protective clothing used will depend to an extent upon the risk associated with the health-care waste, but the following should be made available to all personnel who collect or handle waste:

- obligatory
 - disposable gloves (medical staff) or heavy-duty gloves (waste workers)
 - industrial aprons
 - overalls (coveralls)
 - leg protectors and/or industrial boots
- depending on type of operation
 - eye protectors (safety goggles)
 - face masks (if there is a risk of splash into eyes)
 - helmets, with or without visors.

Industrial boots and heavy-duty gloves are particularly important for waste workers. The thick soles of the boots offer protection in the storage area, as a precaution from spilt sharps, and where floors are slippery. If segregation is inadequate, needles or other sharps items may have been placed in plastic bags; such items may also pierce thin-walled or weak plastic containers. If it is likely that health-care waste bags will come into contact with workers' legs during handling, leg protectors may also need to be worn. An example of the protective clothing recommended in Thailand is shown in Figure 11.1.

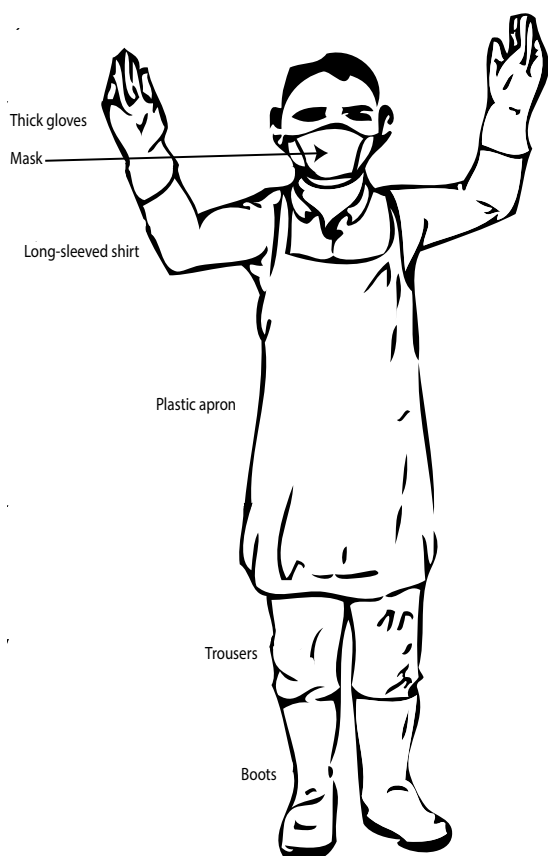

Source: Ministry of Health (1995) (adapted with permission)

Figure 11.1 Recommended protective clothing for health-care waste transportation in small hospitals in Thailand

11.3.5 Occupational post-exposure prophylaxis

Post-exposure prophylaxis (PEP) is short-term antiretroviral treatment (for HIV) or immunization (for hepatitis B) to reduce the likelihood of infection after potential exposure, either occupationally or through sexual intercourse. Within the health sector, PEP should be provided as part of a comprehensive universal precautions package that reduces staff exposure to infectious hazards at work.

PEP for HIV comprises a set of services to prevent development of the infection in the exposed person. These include first-aid care; counselling and risk assessment; HIV blood testing; and, depending on the risk assessment, the provision of short-term (28 days) antiretroviral drugs, with follow-up and support. Most incidents linked to occupational exposure to bloodborne pathogens occur in health-care facilities.

The World Health Organization (WHO) and the International Labour Organization have published guidelines on PEP to prevent HIV infection.¹⁹ A summary of PEP recommendations from these guidelines are as follows:

- WHO recommends that PEP should be provided as part of a package of prevention measures that reduce staff exposure to infectious hazards.
- PEP should be available to health-care workers and patients.
- Occupational PEP should also be available to all workers who could be exposed while performing their duties (such as social workers, law enforcement personnel, rescue workers, refuse collectors).
- Countries should include occupational PEP in national health-care plans.

¹⁹ See http://whqlibdoc.who.int/publications/2007/9789241596374_eng.pdf

- Appropriate training to service providers should ensure the effective management and follow-up of PEP.
- PEP should be initiated as soon as possible within the first few hours and no later than 72 hours after exposure to potentially infected blood or body fluids.
- PEP should not be prescribed to a person already known to be infected with HIV.
- In addition, risk evaluation, and counselling on side effects, and benefits of adherence and psychosocial support is needed.
- Any occupational exposure to HIV should lead to evaluation and, where relevant, strengthening of safety and working conditions.

11.4 Training

Health-care waste workers should be trained before starting work handling waste, and then on a routine basis (e.g. annually) to update their knowledge of prevention and control measures.

Training should include awareness raising about the potential hazards from waste, the purpose of immunization, safe waste-handling procedures, reporting of exposures and injuries, preventing infection following an exposure with PEP, and the use of PPE.

11.5 Minimum approaches to health and safety practices

The minimum approach to health and safety practices for health-care personnel and waste workers includes:

- implementation of standardized management procedures;
- hepatitis B vaccination (in addition to compulsory vaccinations) for all personnel who are at risk of exposure to blood (these personnel include cleaners and waste handlers);
- provision of sharps boxes where injections are taking place;
- implementation of standard precautions, such as no recapping of needles after use;
- promotion of proper hand hygiene;
- availability, as a minimum, of gloves to provide personal protection from patients' body fluids;
- allocation of an additional role (e.g. for an infection-control nurse) to assume responsibility for promoting better worker safety.

11.6 Desirable improvements to the minimum approach

Desirable improvements or additions to the minimum approach to health and safety practices include:

- implementation of safer needle devices
- establishment of health and safety discussions among staff or committees in the local workplace
- establishment of surveillance systems and use of data to prevent further injuries
- a system for post-exposure prophylaxis
- occupational health services formally established at a health-care facility.

Key points to remember

Exposures and injuries are preventable.

Most health-care waste is not hazardous. However, segregation of the waste is essential so that the small proportion of hazardous waste can be handled safely.

Standard safe working precautions are the principal management approach to protect patients and workers from health-care-associated infections.

The waste generation and segregation activities in medical areas have a significant impact on workers involved in waste handling and treatment. Training of medical staff and other users of sharps should include explaining the impact of incorrect waste practices on cleaners and waste handlers. The intention is to emphasize their responsibility to segregate waste properly to protect not only themselves and their patients, but also other workers and the community as a whole. Preventive measures to protect staff performing injections will also protect waste handlers. Placing used sharps in puncture-proof containers is a major part of eliminating needle-stick injuries.

Safer needle devices, such as retractables or needles that blunt or automatically resheath after use, offer added protection but also added cost.

Take measures to protect health-care workers from exposure, injury and occupational disease.

Provide all three doses of hepatitis B immunization to health-care and waste workers.

Identify a responsible person for occupational health.

Allocate sufficient budget to the programme and procure the necessary personal protective equipment.

Provide training to health-care workers and involve them in the identification and control of hazards.

Promote knowledge of the transmission of HIV, hepatitis and tuberculosis through employment or pre-screening for HIV and tuberculosis, and vaccinate against hepatitis B.

Prevent exposure to bloodborne pathogens by applying the hierarchy of controls (see Annex 4 of *Joint ILO/WHO guidelines on health services and HIV/AIDS*; ILO & WHO, 2005).

Maintain a continuous effort to prevent needle-stick injuries and occupational exposures to blood. This could include eliminating unnecessary injections and sharps use, and applying standard precautions (e.g. prohibiting the recapping of needles and ensuring safe disposal immediately after use).

Provide free access to post-exposure prophylaxis for HIV and tuberculosis following an injury.

Promote a “no blame” approach to incident reporting and monitor the quality of services provided.

11.7 References and further reading

References

Bell DM (1997). Occupational risk of human immunodeficiency virus infection in healthcare workers: an overview. *American Journal of Medicine*, 102(5B):9–15.

Cardo DM et al. (1997). A case-control study of HIV seroconversion in health-care workers after percutaneous exposure. *New England Journal of Medicine*, 337:1542–1543.

CDC (Centers for Disease Control and Prevention) (1997). Evaluation of safety devices for preventing percutaneous injuries among health-care personnel during phlebotomy procedures 1993–1995. *Morbidity and Mortality Weekly Report*, 46:21–25 (<http://www.cdc.gov/mmwr/preview/mmwrhtml/00045648.htm>).

EPA (United States Environmental Protection Agency) (2002). *Reducing ethylene oxide and glutaraldehyde use. Environmental best practices for health care facilities*, November 2002 (<http://www.epa.gov/region9/waste/p2/projects/hospital/glutareth.pdf>).

Harrison J (2000). *Is there an alternative to glutaraldehyde? A review of agents used in cold sterilization*. London, Royal College of Nurses.

Hutin Y et al. (2003). Best infection control practices for intradermal subcutaneous, and intramuscular needle

- injections. *Bulletin of the World Health Organization*, 81(7):491–500 (<http://www.who.int/bulletin/volumes/81/7/Hutin0703.pdf>).
- IAEA (International Atomic Energy Agency) (1995). *The principles of radioactive waste management*. Safety Series Report No. 111-F. Vienna, International Atomic Energy Agency.
- IARC (International Agency for Research on Cancer) (1999). Some industrial chemicals. Summary of data reported and evaluation. *IARC Monographs on the Evaluation of Carcinogenic Risks to Humans*, 60.
- ILO (International Labour Organization), WHO (World Health Organization) (2005). Fact sheet 4: Hierarchy of controls applied to risk of bloodborne pathogen exposure. In: *Joint ILO/WHO guidelines on health services and HIV/AIDS*. Geneva, World Health Organization.
- International Programme on Chemical Safety (1999). *International Chemical Safety Card ICSC: 0482 Sodium hypochlorite*. World Health Organization, International Labour Organization, United Nations Environment Program (<http://www.inchem.org/documents/icsc/icsc/eics0482.htm>).
- International Programme on Chemical Safety (2003). *Concise international chemical assessment document 54: ethylene oxide*. Geneva, World Health Organization (<http://www.inchem.org/pages/cicads.html>).
- Jefferson T et al. (2008). Physical interventions to interrupt or reduce the spread of respiratory viruses: systematic review. *British Medical Journal*, 336:77–80.
- Lamontagne F et al. (2007). Role of safety-engineered devices in preventing needlestick injuries in 32 French hospitals. *Infection Control and Hospital Epidemiology*, 28:18–23.
- Ministry of Health (1995). *Handbook of hazardous health care waste management in 10-bed and 30-bed community hospitals*. Bangkok, Ministry of Health.
- Mirabelli MC et al. (2007). Occupational risk factors for asthma among nurses and related healthcare professionals in an international study. *Occupational and Environmental Medicine*, 64(7):474–479.
- Nelson A, ed. (2003). *Patient care ergonomics resource guide: safe patient handling & movement*. Washington, DC, United States Department of Veterans Affairs (<http://www.vis8.va.gov/patientsafetycenter/resguide/>).
- Niu S, Deboodt P, Zeeb, H, eds. (2010). *Approaches to attribution of detrimental health effects to occupational ionizing radiation exposure and their application in compensation programmes for cancer: a practical guide*. Occupational Safety and Health Series No. 73. Geneva, International Atomic Energy Agency, International Labour Organization and World Health Organization.
- Pechter E et al. (2005). Work-related asthma among health care workers: surveillance data from California, Massachusetts, Michigan, and New Jersey, 1993–1997. *American Journal of Industrial Medicine*, 47(3):265–275.
- Prüss-Ustün A, Rapiti E, Hutin Y (2005). Estimation of the global burden of disease attributable to contaminated sharps injuries among health-care workers. *American Journal of Industrial Medicine* 48(6):482–490.
- Puro V et al. (2010). Update on the subject of epidemiology of blood-transmitted occupational infections. *Giornale Italiano di Medicina del Lavoro ed Ergonomia*, 32(3):235–239.
- Reinhardt PA, Gordon JG (1991). *Infectious and medical waste management*. Chelsea, Michigan, Lewis Publishers.
- Schneider E, Irastorza X (2010). *OSH in figures: work-related musculoskeletal disorders in the EU – facts and figures*. Luxembourg, Publications Office of the European Union.
- WHO (World Health Organization) (2007a). *Infection prevention and control of epidemic- and pandemic-prone acute respiratory diseases in health care: WHO interim guidelines*. Geneva, World Health Organization (http://www.who.int/csr/resources/publications/WHO_CDS_EPR_2007_6c.pdf).

- WHO (2007b). *Aide memoire: standard precautions in health care*. Geneva, World Health Organization (http://www.who.int/csr/resources/publications/EPR_AM2_E7.pdf).
- WHO (2009a). Hepatitis B vaccines – WHO Position Paper. *Weekly Epidemiological Record (WER)*, 40(84):405–420.
- WHO (2009b). Annex 1: Quantification of TB transmission. In: *Selected settings in WHO policy on TB infection control in health-care facilities, congregate settings and households*. Geneva, World Health Organization.
- WHO (2009c). *WHO policy on TB infection control in health-care facilities, congregate settings and households*. Geneva, World Health Organization (http://www.who.int/tb/publications/2009/infection_control/en/index.html).
- WHO (2009d). *Natural ventilation for infection control in health-care settings*. Geneva, World Health Organization (http://www.who.int/water_sanitation_health/publications/natural_ventilation/en).
- WHO (2010). *WHO best practices for injections and related procedures toolkit*. Geneva, World Health Organization (http://whqlibdoc.who.int/publications/2010/9789241599252_eng.pdf).
- WHO, ILO (International Labour Organization) (2007). *Post-exposure prophylaxis to prevent HIV infection: joint WHO/ILO guidelines on post-exposure prophylaxis (PEP) to prevent HIV infection*. Geneva, World Health Organization and International Labour Organization (<http://www.who.int/hiv/pub/guidelines/PEP/en/>).
- Weber AM, Boudreau Y, Mortimer V (1998). *Health hazard evaluation report 98-0027-2709 Stericycle, Inc*. Washington, DC, US Department of Health and Human Services, Centers for Disease Control and Prevention, National Institute for Occupational Safety and Health (<http://www.cdc.gov/niosh/hhe/reports/.../1998-0027-2709.pdf>).
- Zock JP et al. (2007). The use of household cleaning sprays and adult asthma: an international longitudinal study. *American Journal of Respiratory Critical Care Medicine*, 176:735–741.
- Zock JP, Vizcaya D, Le Moual N (2010). Update on asthma and cleaners. *Current Opinion in Allergy and Clinical Immunology*, 10(2):114–120.

Further reading

- DHHS (US Department of Health and Human Services), CDC (Centers for Disease Control and Prevention), NIOSH (National Institute for Occupational Safety and Health) (1998). *Selecting, evaluating, and using sharps disposal containers*. Atlanta, Centers for Disease Control and Prevention (<http://www.cdc.gov/niosh/pdfs/97-111.pdf>).
- DHHS, CDC, NIOSH (2009). *State of the sector: healthcare and social assistance identification of research opportunities for the next decade of NORA*. Publication No. 2009–139. Atlanta, Centers for Disease Control and Prevention.
- DHHS, CDC, NIOSH (2010). *Workbook for designing, implementing, and evaluating a sharps injury prevention program*. Atlanta, Centers for Disease Control and Prevention (available at <http://www.cdc.gov/sharpsafety>).
- Gold J et al. (2004). *Guidance note on health care worker safety from HIV and other blood borne infections*. Washington, DC, The World Bank (<http://siteresources.worldbank.org/HEALTHNUTRITIONANDPOPULATION/Resources/281627-1095698140167/GoldGuidanceNote.pdf>).
- ILO (International Labour Organization), WHO (World Health Organization) (2005). *Joint ILO/WHO guidelines on health services and HIV/AIDS*. Geneva, World Health Organization (http://www.who.int/hiv/pub/prev_care/healthservices/en/index.html).

ILO, WHO (2007). *Joint WHO/ILO guidelines on post-exposure prophylaxis (PEP) to prevent HIV infection*. Geneva, World Health Organization (http://whqlibdoc.who.int/publications/2007/9789241596374_eng.pdf).

ILO, WHO (2011). *Joint WHO-ILO policy guidelines on improving health workers' access to HIV and TB prevention, treatment, care and support services*. Geneva, International Labour Organization, Joint United Nations Programme on HIV/AIDS and World Health Organization (http://www.who.int/occupational_health/publications/hiv_tb_guidelines/en/index.html).

WHO (World Health Organization) (2003). *Aide memoire on health care worker safety*. Geneva, World Health Organization (http://www.who.int/occupational_health/activities/1am_hcw.pdf).

WHO (2005). *Protecting health care workers – preventing needlestick injuries tool kit*. Geneva, World Health Organization (http://www.who.int/occupational_health/activities/pnitookit/en/index.html).

WHO (2012). *Clean care is safer care, website of tools and materials*. Geneva, World Health Organization (<http://www.who.int/gpsc/5may/tools/en/index.html>).

12 Hospital hygiene and infection control

Key questions to answer

- What are the potential routes of disease transmission and how can they be eliminated?
 - What are the proper techniques for hand washing and the use of hand rub?
 - What are the main disinfectant groups, their advantages and disadvantages?
 - What are the proper steps to take for thorough cleaning and disinfection?
 - How can proper health-care waste management minimize disease transmission?
-

12.1 Guiding principles

Management of health-care waste is an integral part of hospital hygiene and infection control. Health-care waste can be considered as a reservoir of pathogenic microorganisms, which – if someone is exposed – could give rise to an avoidable infection. If waste is inadequately managed, these microorganisms can be transmitted by direct contact, by inhalation or by a variety of animal vectors (e.g. flies, rodents, roaches), which could come into contact with waste.

This chapter outlines the basic principles of prevention and control of infections that may be acquired in health-care facilities. It does not address other aspects of hospital hygiene and infection control and safety, such as bloodstream and urinary tract infections. It is stressed that other environmental health considerations, such as adequate water supply and sanitation facilities for patients, visitors and health-care staff, are of prime importance in minimizing the transmission of infections.

12.2 Chain of infection

A basic infection-control principle is to know the chain of infection and identify the most effective points to prevent potential disease transmission. Transmission of infectious diseases in a health-care facility requires at least six elements: an infectious agent, a reservoir, a portal of exit, a means of transmission, a portal of entry, and a susceptible host. Numerous actions, some of which are described in this chapter, can be taken to break the links in this chain of events.

12.3 Epidemiology of nosocomial infections

Nosocomial infections (also known as hospital-acquired infections, hospital-associated infections and hospital infections) are infections that are not present in the patient at the time of admission to a health-care facility but develop during the course of the patient's stay.

Nosocomial infections occur as a result of medical procedures performed on patients that lead to infections from a patient's own (endogenous) flora or as a result of exposure to items contaminated with infectious agents. Additionally, the risk of acquiring an infection increases for patients with altered or compromised immunity.

Human beings are reservoirs of numerous types of microorganisms. Faeces contain approximately 10^{13} bacteria per gram, and the number of microorganisms on skin varies between 10^2 and 10^4 per cm^2 . Many species of microorganisms live on mucous membranes and are considered normal flora. When the integrity of these barriers is challenged (e.g. microorganisms penetrate the skin or the mucous membrane), this creates an opportunity for an infection to occur.

12.3.1 Transition from exposure to infection

Whether an infection will develop after an exposure to microorganisms depends upon the interaction between the microorganisms and the host. Healthy individuals have a normal general resistance to infection. Patients with underlying disease, newborn babies and the elderly have less resistance and are at greater risk to develop an infection after exposure.

Local resistance to infection also plays an important role: the skin and the mucous membranes act as barriers in contact with the environment. Infection may occur when these barriers are breached. Local resistance may also be overcome by the long-term presence of an irritant, such as a cannula or catheter. The likelihood of infection increases daily when a patient has a catheter attached.

The most important determinants of infection are the nature and number of the infectious agents. Microorganisms range from the completely innocuous to the extremely pathogenic; the former will never cause an infection even in immunocompromised individuals, while the latter will cause an infection in virtually every case of exposure. A classification of conventional, conditional and opportunistic pathogens is given in Box 12.1.

When only a few organisms are present, an infection will not necessarily develop. However, when a critical number is exceeded, it is very likely that an infection will become established. For every type of microorganism, the *minimal infective dose* can be determined. This is the lowest number of bacteria, viruses or fungi that cause the first clinical signs of infection in a healthy individual. For most causative agents of nosocomial infections, the minimal infective dose is relatively high. For example, for *Klebsiella* and *Serratia* spp. and other Enterobacteriaceae, it is more than 10^5 colony-forming units (CFUs)/gram, but for hepatitis B virus it is less than 10 plaque-forming units (PFUs)/gram.

Box 12.1 Classification of pathogenic organisms

Conventional pathogens

Cause disease in healthy individuals in the absence of specific immunity.

Examples:

- Methicillin-resistant *Staphylococcus aureus*, *Streptococcus pyogenes* (beta strep group A), *Salmonella* spp., *Shigella* spp., vancomycin-resistant *Enterococcus*, *Corynebacterium diphtheriae*, *Mycobacterium tuberculosis*, *Bordetella pertussis*, hepatitis A and B viruses, rubella virus, rotaviruses, human immunodeficiency virus (HIV).

Conditional pathogens

Cause disease, other than trivial local infections, only in persons with reduced resistance to infection (including newborn infants) or when implanted directly into tissue or a normally sterile body area.

Examples:

- *Streptococcus agalactiae*, *Enterococcus* spp., *Clostridium tetani*, *Escherichia coli*, *Klebsiella* spp., *Serratia marcescens*, *Acinetobacter baumannii*, *Pseudomonas aeruginosa*, *Candida* spp.

Opportunistic pathogens

Cause generalised disease, but only in patients with profoundly diminished resistance to infection.

Examples:

- Atypical mycobacteria, *Nocardia asteroides*, *Pneumocystis carinii*.

Source: Parker (1978)

12.3.2 Sources of infection

In a health-care facility, the sources of infectious agents may be the personnel, the patients or the inanimate environment.

The hospital environment can be contaminated with pathogens. *Salmonella* or *Shigella* spp., *Escherichia coli* O157:H7 or other pathogens may be present in the food and cause an outbreak, just as they can in a community outside the hospital. Waterborne infections may develop if the water-distribution system breaks down. In more sophisticated facilities, the water-cooling system of air-conditioning equipment may become contaminated with *Legionella pneumophila*, causing Legionnaires' disease in susceptible patients. Pharmaceuticals may become contaminated during production or preparation; an outbreak of infection by *Pseudomonas aeruginosa*, *Burkholderia cepacia* or *Serratia marcescens* may occur as a consequence. In all these examples, it may be possible to isolate the same causative agent in several patients, which would suggest a common source. All possible measures should be taken to prevent the recurrence of such incidents.

The source of a nosocomial infection may also be a health-care worker who is infected or colonized (a carrier) with an infectious agent. The symptoms of infection will make the potential transmission apparent to the health-care worker and/or to managerial staff, and infected personnel are usually taken off patient care duties. Sometimes a carrier may be symptomless (i.e. is colonized by potentially pathogenic organisms but does not develop any infection). A typical example is methicillin-resistant *Staphylococcus aureus*, which may be carried in the nasal passages of 30–60% of health-care personnel. Faecal carriage of enteropathogens such as *Salmonella* spp. also occurs frequently, but the prevalence varies according to the region. Other conventional pathogens that can be found in symptomless carriers include *Streptococcus pyogenes*, *Corynebacterium diphtheriae*, *Neisseria meningitidis*, hepatitis B virus and cytomegalovirus. Exposure of patients to carriers can give rise to an outbreak of disease. Careful investigation and isolation of the same organisms from a cluster of patients as well as the carrier should reveal the cause of the outbreak.

The source of most hospital epidemics is infected patients; that is, patients infected with pathogenic microorganisms. These microorganisms are often released into the environment in very high numbers, depending on the disease, exceeding the minimal infective dose, and exposing other patients, who subsequently develop hospital-acquired infections. The recent case of severe acute respiratory syndrome and its impact on health-care waste-generation rates (Chiang et al., 2006) is a classic example of hospital-based epidemics relating to a respiratory disease.

12.3.3 Routes of transmission

In health-care settings, the main modes of transmission from a source to a new host are:

- contact transmission
 - direct contact (e.g. a surgeon with an infected wound on a finger performs a wound dressing);
 - indirect contact (e.g. secretions transferred from one patient to another via hands in contact with a contaminated waste item);
 - faecal–oral via food
- bloodborne transmission
 - blood is transferred via sharps or needle stick injuries, transfusion or injection.
- droplet transmission
 - infectious droplets expelled into the air or onto a surface (e.g. when sneezing, coughing, vomiting); the droplets are too heavy to remain in suspension in the air and typically fall <2 m from the source;
 - direct droplet transmission – droplets reach mucous membranes or are inhaled;
 - droplet-to-contact transmission – droplets contaminate surfaces/hands and are transmitted to another site (e.g. mucous membranes); indirect droplet transmission is often a more efficient transmission route than direct transmission (examples are the common cold, respiratory syncytial virus)
- airborne transmission

- small particles carrying microbes are transferred as aerosols via air currents for >2 m from the source (e.g. droplet nuclei or skin scales); direct airborne transmission can be from particles in suspension in air (e.g. *Varicella zoster*) or from deposition on to contaminated wounds (e.g. *Staphylococcus aureus*) (Siegel et al., 2007)
- vector transmission
 - typical in countries where insects, arthropods and other pests are widespread; these vectors become exposed to a disease organism (such as on the feet of flying insects) through contact with excreta or secretions from an infected patient and transmit the infective organisms directly to other patients.

Figure 12.1 summarizes the spread of nosocomial infections.

12.4 Prevention of nosocomial infections

Two basic principles govern the main control measures to prevent the spread of nosocomial infections in health-care facilities:

- separate an identified source of infection from other patients and medical areas
- eliminate all obvious routes of transmission.

The separation of the source has to be interpreted in a broad sense. It includes the isolation of infected patients and implements aseptic conditions by introducing measures intended to act as a barrier between infected or potentially contaminated tissue and the environment, including other patients and medical staff.

In recent years, increasing attention has been paid to the protection of the personnel against the transmission of bloodborne infections, such as acquired immunodeficiency syndrome (AIDS), and viral hepatitis B and C. Preventive measures are known as “universal”. In 1996, the Centers for Disease Control and Prevention published new guidelines (standard precautions) for isolation precautions in hospitals (Garner, 1996). Standard precautions synthesize the major features of body substance isolation and universal precautions to prevent transmission of a variety of organisms. Standard precautions were developed for use in hospitals and may not necessarily be indicated in other settings where universal precautions are used, such as childcare facilities and schools.

12.4.1 Standard precautions

Standard precautions should be taken with every patient, independent of any known condition (e.g. infected or colonized), to protect health-care workers from exposure to infectious disease. These precautions are summarized in Figure 12.2 and are designed to prevent cross-transmission before a diagnosis is known. All objects that come in contact with patients should be considered potentially contaminated.

Some areas use the term “routine practices” instead of standard precautions. Standard precaution measurements are outlined in Chapter 11. The routes of transmission intended to be prevented by basic hygienic precautions are:

- contact
- bloodborne
- droplet.

It is impossible to avoid all contact with infected tissue or potentially contaminated body fluids, excreta and secretions. Even when they are not touched with the bare hands, they may come in contact with instruments, containers, linen or similar items.

If an object is disposable, it should be discarded as waste. If it is reusable, transmission of infective agents must be prevented by cleaning, disinfection or sterilization, in accordance with manufacturers’ instructions.

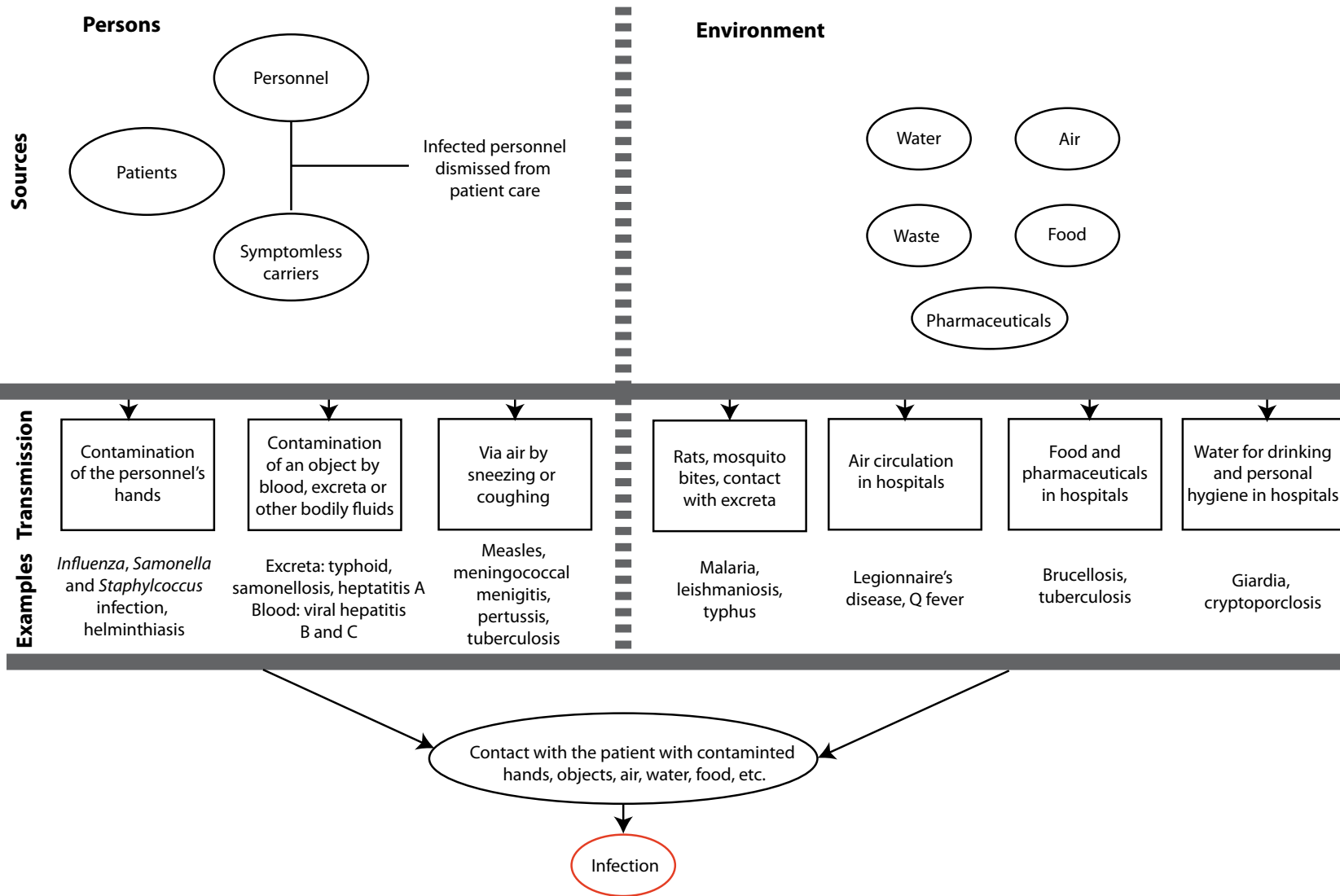

Note: Many of the listed diseases can spread by more than one route. The figure shows only a few of the many diseases that may be transmitted within a health-care facility.
Source: Itext WHO 98532

Figure 12.1 The spread of nosocomial infections

12.4.2 Isolation of infected patients and standard precautions

The first measure in preventing the spread of nosocomial infections is the isolation of infected patients. The term “isolation” covers a broad range of measures. The strictest form of isolation is applied for very infectious diseases (e.g. haemorrhagic fever, diphtheria). Less stringent precautions can be taken in the case of diseases such as tuberculosis, other respiratory infections and infectious diarrhoea.

Maintaining isolation is expensive, labour-intensive and usually inconvenient or uncomfortable for both patients and health-care personnel. Its implementation should be adapted to the severity of the disease and to the causative agent. Disease-specific precautions should include details of all the measures (e.g. private room, wearing of masks or gowns) to be taken.

12.4.3 Cleaning

Cleaning is one of the most basic measures for maintaining hygiene in the health-care environment. The principal aim of cleaning is to remove visible dirt. It is essentially a mechanical process whereby the dirt is dislodged from a surface, suspended or dissolved in a water film, diluted until it is no longer visible, and rinsed off. Soaps and detergents act as solubility-promoting agents. The microbiological effect of cleaning is also essentially mechanical: bacteria and other microorganisms are suspended in the cleaning fluid and removed from the surface. The efficacy of the cleaning process depends completely on this mechanical action, since neither soap nor detergents possess any antimicrobial activity. Thorough cleaning will remove more than 90% of microorganisms. However, careless and superficial cleaning is much less effective; it is even possible that it has a negative effect, by dispersing the microorganisms over a greater surface and increasing the chance that they may contaminate other objects.

Cleaning should be carried out in a standardized manner and preferably by automated means that will guarantee an adequate level of cleanliness. Diluting and removing the dirt also removes the breeding ground or culture medium for bacteria and fungi. Most non-sporulating bacteria and viruses survive only when they are protected by dirt or a film of organic matter; otherwise, they dry out and die.

12.4.4 Sterilization and disinfection

The effectiveness of disinfection and sterilization is increased by prior or simultaneous cleaning. Self-evidently, an object should be sterile (i.e. free of microorganisms) after sterilization. However, sterilization is never absolute; by definition, it reduces the number of microorganisms by a factor of more than 10^6 (i.e. more than 99.9999% of microorganisms are killed). Standard reference works, such as pharmacopoeias, often state that no more than one out of a million sterilized items may still bear microorganisms. It is therefore important to minimize the level of contamination of the material to be sterilized. This is done by sterilizing only objects that are first cleaned (free of visible dirt) and applying the principles of good operating practice.

The term “disinfection” is difficult to define, because the activity of a disinfectant process can vary widely. The guidelines for environmental infection control in health-care facilities (CDC, 2003) allow the following distinctions to be made:

- *high-level disinfection*: can be expected to destroy all microorganisms, with the exception of large numbers of bacterial spores;
- *intermediate disinfection*: inactivates *Mycobacterium tuberculosis*, vegetative bacteria, most viruses and most fungi; does not necessarily kill bacterial spores;
- *low-level disinfection*: can kill most bacteria, some viruses and some fungi; cannot be relied on to kill resistant microorganisms such as tubercle bacilli or bacterial spores.

There is no ideal disinfectant, and the best compromise should be chosen according to the situation. A disinfectant solution is considered appropriate when the compromise between the antimicrobial activity and the toxicity of the product is satisfactory for the given application. Another consideration may well be the cost. The more active disinfectants are also the more toxic ones; potentially toxic products can be applied to inanimate objects or surfaces, whereas only the less toxic disinfectants can be considered for disinfection of human tissues. For antiseptics, different disinfectants are used for application to intact skin (e.g. alcoholic solutions) and to mucous membranes or wounds (only aqueous solutions of non-toxic substances). Cost is a less important consideration for an antiseptic than for a disinfectant.

The principal requirements for a good antiseptic are absence of toxicity, rapid action, and adequate activity on natural flora and pathogenic bacteria and other microorganisms after a very short exposure time. Essential requirements for a disinfectant are somewhat different. There must be adequate activity against bacteria, fungi and viruses that may be present in large numbers and protected by dirt or organic matter. In addition, since disinfectants are applied in large quantities, they should be of low ecotoxicity.

In general, use of the chosen disinfectant, at the appropriate concentration and for the appropriate time, should kill pathogenic microorganisms, rendering an object safe for use in a patient, or rendering human tissue free of pathogens to exclude cross-contamination. An overview of the characteristics of the main groups of disinfectants is given in Table 12.1.

Table 12.1 Characteristics of the main disinfectant groups

Agent	Spectrum	Uses	Advantages	Disadvantages
Alcohols (60–90%) including ethanol or isopropanol	Low- to intermediate-level disinfectant	Used for some semicritical and noncritical items (e.g. oral and rectal thermometers and stethoscopes) Used to disinfect small surfaces such as rubber stoppers of multidose vials Alcohols with detergent are safe and effective for spot disinfection of countertops, floors and other surfaces	Fast acting No residue No staining Low cost Readily available in all countries	Volatile, flammable, and irritant to mucous membranes Inactivated by organic matter May harden rubber, cause glue to deteriorate, or crack acrylate plastic
Chlorine and chlorine compounds: the most widely used is an aqueous solution of sodium hypochlorite 5.25–6.15% (household bleach) at a concentration of 100–5000 ppm free chlorine	Low- to high-level disinfectant	Used for disinfecting tonometers and for spot disinfection of countertops and floors Can be used for decontaminating blood spills Concentrated hypochlorite or chlorine gas is used to disinfect large and small water-distribution systems such as dental appliances, hydrotherapy tanks, and water-distribution systems in haemodialysis centres	Low cost, fast acting Readily available in most settings Available as liquid, tablets or powders	Corrosive to metals in high concentrations (>500 ppm) Inactivated by organic material Causes discoloration or bleaching of fabrics Releases toxic chlorine gas when mixed with ammonia Irritant to skin and mucous membranes Unstable if left uncovered, exposed to light or diluted; store in an opaque container
Glutaraldehyde: $\geq 2\%$ aqueous solutions buffered to pH 7.5–8.5 with sodium bicarbonate Novel glutaraldehyde formulations include: <ul style="list-style-type: none"> • glutaraldehyde • phenol-sodium-phenate • potentiated acid glutaraldehyde • stabilized alkaline glutaraldehyde. 	High-level disinfectant/sterilant	Most widely used as high-level disinfectant for heat-sensitive semicritical items such as endoscopes (for 20 minutes at 20 °C)	Good material compatibility	Allergenic, and its fumes are irritating to skin and respiratory tract Causes severe injury to skin and mucous membranes on direct contact Relatively slow activity against some mycobacterial species Must be monitored for continuing efficacy levels
Peracetic acid 0.2–0.35% and other stabilized organic acids	High-level disinfectant/sterilant	Used in automated endoscope reprocessors Can be used for cold sterilization of heat-sensitive critical items (e.g. haemodialysers) Also suitable for manual instrument processing (depending on the formulation)	Rapid sterilization cycle time at low temperature (30–45 min. at 50–55 °C) Active in presence of organic matter Environment friendly by-products (oxygen, water, acetic acid)	Corrosive to some metals Unstable when activated May be irritating to skin, conjunctiva and mucous membranes

Table 12.1 *continued*

Agent	Spectrum	Uses	Advantages	Disadvantages
Orthophthalaldehyde (OPA) 0.55%	High-level disinfectant/sterilant	High-level disinfectant for endoscopes	Excellent stability over wide pH range, no need for activation Superior mycobactericidal activity compared with glutaraldehyde Does not require activation	Expensive Stains skin and mucous membranes May stain items that are not cleaned thoroughly Eye irritation with contact May cause hypersensitivity reactions in bladder cancer patients following repeated exposure to manually processed urological instruments Slow sporicidal activity Must be monitored for continuing efficacy levels
Hydrogen peroxide 7.5%	High-level disinfectant/sterilant	Can be used for cold sterilization of heat-sensitive critical items Requires 30 min at 20 °C	No odour Environment friendly by-products (oxygen, water)	Material compatibility concerns with brass, copper, zinc, nickel/silver plating
Hydrogen peroxide 7.5% and peracetic acid 0.23%	High-level disinfectant/sterilant	For disinfecting haemodialysers	Fast-acting (high-level disinfection in 15 min) No activation required No odour	Material compatibility concerns with brass, copper, zinc and lead Potential for eye and skin damage
Glucoprotamin	High-level disinfectant	Used for manual reprocessing of endoscopes Requires 15 min at 20 °C	Highly effective against mycobacteria High cleansing performance No odour	Lack of effectiveness against some enteroviruses and spores
Phenolics	Low- to intermediate-level disinfectant	Have been used for decontaminating environmental surfaces and non-critical surfaces Should be avoided	Not inactivated by organic matter	Leaves residual film on surfaces Harmful to the environment No activity against viruses Use in nurseries should be avoided due to reports of hyperbilirubinemia in infants
Iodophores (30–50 ppm free iodine)	Low-level disinfectant	Have been used for disinfecting some non-critical items (e.g. hydrotherapy tanks); however, they are used mainly as an antiseptic (2–3 ppm free iodine)	Relatively free of toxicity or irritancy	Inactivated by organic matter Adversely affects silicone tubing May stain some fabrics

Source: adapted from Friedman & Newsom (2011)

Standard precautions in health care

Background

Standard precautions are meant to reduce the risk of transmission of bloodborne and other pathogens from both recognized and unrecognized sources.

They are the basic level of infection control precautions which are to be used, as a minimum, in the care of all patients.

Hand hygiene is a major component of standard precautions and one of the most effective methods to prevent transmission of pathogens associated with health care. In addition to hand hygiene, the use of **personal protective equipment** should be guided by **risk assessment** and the extent of contact anticipated with blood and body fluids, or pathogens.

In addition to practices carried out by health workers when providing care, all individuals (including patients and visitors) should comply with infection control practices in health-care settings. The control of spread of pathogens from the source is key to avoid transmission. Among source control measures, **respiratory hygiene/cough etiquette**, developed during the severe acute respiratory syndrome (SARS) outbreak, is now considered as part of standard precautions.

Worldwide escalation of the use of standard precautions would reduce unnecessary risks associated with health care. Promotion of an **institutional safety climate** helps to improve conformity with recommended measures and thus subsequent risk reduction. Provision of adequate staff and supplies, together with leadership and education of health workers, patients, and visitors, is critical for an enhanced safety climate in health-care settings.

Important advice

- Promotion of a safety climate is a cornerstone of prevention of transmission of pathogens in health care.
- Standard precautions should be the minimum level of precautions used when providing care for all patients.
- Risk assessment is critical. Assess all health-care activities to determine the personal protection that is indicated.
- Implement source control measures for all persons with respiratory symptoms through promotion of respiratory hygiene and cough etiquette.

✓ Checklist

Health policy

- Promote a safety climate.
- Develop policies which facilitate the implementation of infection control measures.

Hand hygiene

- Perform hand hygiene by means of hand rubbing or hand washing (see detailed indications in table).
- Perform hand washing with soap and water if hands are visibly soiled, or exposure to spore-forming organisms is proven or strongly suspected, or after using the restroom. Otherwise, if resources permit, perform hand rubbing with an alcohol-based preparation.
- Ensure availability of hand-washing facilities with clean running water.
- Ensure availability of hand hygiene products (clean water, soap, single use clean towels, alcohol-based hand rub). Alcohol-based hand rubs should ideally be available at the point of care.

Personal protective equipment (PPE)

- ASSESS THE RISK of exposure to body substances or contaminated surfaces **BEFORE** any health-care activity. **Make this a routine!**
- Select PPE based on the assessment of risk:
 - clean non-sterile gloves
 - clean, non-sterile fluid-resistant gown
 - mask and eye protection or a face shield.

Respiratory hygiene and cough etiquette

- Education of health workers, patients and visitors.
- Covering mouth and nose when coughing or sneezing.
- Hand hygiene after contact with respiratory secretions.
- Spatial separation of persons with acute febrile respiratory symptoms.



EPIDEMIC AND PANDEMIC ALERT AND RESPONSE

© World Health Organization 2007



World Health Organization

Figure 12.2 Aide memoir for standard precautions in health care

Health-care facility recommendations for standard precautions

KEY ELEMENTS AT A GLANCE

1. Hand hygiene¹

Summary technique:

- Hand washing (40–60 sec): wet hands and apply soap; rub all surfaces; rinse hands and dry thoroughly with a single use towel; use towel to turn off faucet.
- Hand rubbing (20–30 sec): apply enough product to cover all areas of the hands; rub hands until dry.

Summary indications:

- Before and after any direct patient contact and between patients, whether or not gloves are worn.
- Immediately after gloves are removed.
- Before handling an invasive device.
- After touching blood, body fluids, secretions, excretions, non-intact skin, and contaminated items, even if gloves are worn.
- During patient care, when moving from a contaminated to a clean body site of the patient.
- After contact with inanimate objects in the immediate vicinity of the patient.

2. Gloves

- Wear when touching blood, body fluids, secretions, excretions, mucous membranes, nonintact skin.
- Change between tasks and procedures on the same patient after contact with potentially infectious material.
- Remove after use, before touching non-contaminated items and surfaces, and before going to another patient. Perform hand hygiene immediately after removal.

3. Facial protection (eyes, nose, and mouth)

- Wear (1) a surgical or procedure mask and eye protection (eye visor, goggles) or (2) a face shield to protect mucous membranes of the eyes, nose, and mouth during activities that are likely to generate splashes or sprays of blood, body fluids, secretions, and excretions.

4. Gown

- Wear to protect skin and prevent soiling of clothing during activities that are likely to generate splashes or sprays of blood, body fluids, secretions, or excretions.
- Remove soiled gown as soon as possible, and perform hand hygiene.

5. Prevention of needle stick and injuries from other sharp instruments²

Use care when:

- Handling needles, scalpels, and other sharp instruments or devices.
- Cleaning used instruments.
- Disposing of used needles and other sharp instruments.

6. Respiratory hygiene and cough etiquette

Persons with respiratory symptoms should apply source control measures:

- Cover their nose and mouth when coughing/sneezing with tissue or mask, dispose of used tissues and masks, and perform hand hygiene after contact with respiratory secretions.

Health-care facilities should:

- Place acute febrile respiratory symptomatic patients at least 1 metre (3 feet) away from others in common waiting areas, if possible.
- Post visual alerts at the entrance to health-care facilities instructing persons with respiratory symptoms to practise respiratory hygiene/cough etiquette.
- Consider making hand hygiene resources, tissues and masks available in common areas and areas used for the evaluation of patients with respiratory illnesses.

7. Environmental cleaning

- Use adequate procedures for the routine cleaning and disinfection of environmental and other frequently touched surfaces.

8. Linens

Handle, transport, and process used linen in a manner which:

- Prevents skin and mucous membrane exposures and contamination of clothing.
- Avoids transfer of pathogens to other patients and or the environment.

9. Waste disposal

- Ensure safe waste management.
- Treat waste contaminated with blood, body fluids, secretions and excretions as clinical waste, in accordance with local regulations.
- Human tissues and laboratory waste that is directly associated with specimen processing should also be treated as clinical waste.
- Discard single use items properly.

10. Patient care equipment

- Handle equipment soiled with blood, body fluids, secretions, and excretions in a manner that prevents skin and mucous membrane exposures, contamination of clothing, and transfer of pathogens to other patients or the environment.
- Clean, disinfect, and reprocess reusable equipment appropriately before use with another patient.

¹ For more details, see: WHO Guidelines on Hand Hygiene in Health Care (Advanced draft), at: http://www.who.int/patientsafety/information_centre/ghhad_download/en/index.html.

² The SIGN Alliance at: http://www.who.int/injection_safety/sign/en/

12.4.5 Hand hygiene

The hands of health-care workers are the most frequent transmission route for nosocomial infections. Hand hygiene, both hand washing and hand disinfection, should be seen as the primary preventive measure that is the responsibility of all health-care personnel.

Thorough hand washing with adequate quantities of water and soap removes more than 90% of the transient (i.e. superficial) flora, including all or most contaminants. An antimicrobial soap will further reduce the transient flora, but only if used for several minutes. Hand washing with (non-medicated) soap is essential when hands are dirty and should be routine after every physical contact with a patient.

Killing *all* transient flora within a short time (a few seconds) necessitates hygienic hand disinfection: *only alcohol or alcoholic preparations act sufficiently fast*. Hands should be disinfected with alcohol when an infected tissue or body fluid is touched without gloves. An overview of the main forms of hand hygiene is given in Table 12.2.

Table 12.2 The main forms of hand hygiene

Technique	Main purpose	Influence on hand flora	Agents	Rapidity of action	Residual effect
Social hand washing	Cleansing	Reduces transient flora	Non-medicated soap	Slow	Short
Careful hand washing	Cleansing after patient contact	Partly removes transient flora	Non-medicated soap	Slow	Short
Hygienic hand disinfection	Disinfection after contamination	Kills transient flora	Alcohol	Fast	Short
Surgical hand disinfection	Preoperative disinfection	Kills transient flora and inhibits resident flora	Antibacterial soap, alcoholic solutions	Slow (soap) or fast (alcohol)	Long

The World Health Organization's (WHO's) *WHO guidelines on hand hygiene in health care* (WHO, 2009) include a recipe for alcohol hand rub, for local production (see page 49 of the guidelines).²⁰ The WHO (2009) guidelines also include the following guidance for hand washing and use of alcohol-based hand rubs:

- If hands are not visibly soiled, use an alcohol-based hand rub for routine antisepsis (hygienic hand disinfection). Rub until hands are dry.
- Wash hands before starting work, before entering an operating theatre, before eating, after using a toilet, and in all cases where hands are visibly soiled.
- Keep nails short and clean.
- Do not wear artificial fingernails, nail polish or jewellery.
- Do not wash gloves between uses with different patients.
- Multiple-use cloth towels of the hanging or roll type are not recommended for health-care institutions.
- When bar soap is used, soap racks that facilitate drainage and only small bars should be used; liquid detergents in dispensers are preferred.
- To prevent contamination, do not add soap to a partially empty liquid-soap dispenser. Empty the dispenser completely and clean it thoroughly before refilling.
- Hand hygiene products should have low skin irritation, particularly in multiple-use areas, such as intensive-care or operating rooms.
- Ask personnel for their views regarding the tolerance of any products under consideration.

²⁰ See http://whqlibdoc.who.int/publications/2009/9789241597906_eng.pdf

- For surgical scrub, preferably use an alcohol-based hand rub.
- When using an alcohol-based surgical hand rub, pre-wash with soap, and dry hands and forearms completely (including removal of debris from underneath the nails using a nail cleaner) once a day before starting surgery and when hands become soiled (e.g. glove perforation) or sweaty. Brushes are not necessary and can be a source of contamination. Hand washing immediately before every rub does not improve its efficacy and should be abandoned. Rub for 1–5 minutes according to the manufacturer’s recommendation after application, and rub until hands are dry before donning sterile gloves.
- Hands must be fully dry before touching the patient or patient’s environment/equipment for the alcohol hand rub to be effective. This will also eliminate the extremely rare risk of flammability.
- Use hand lotions frequently to minimize the possibility of irritant contact dermatitis.

Figures 12.3 and 12.4 demonstrate proper techniques for hand washing and use of alcohol rubs.

How to Handrub?

RUB HANDS FOR HAND HYGIENE! WASH HANDS WHEN VISIBLY SOILED

 Duration of the entire procedure: **20–30 seconds**



 **World Health Organization**

Patient Safety
A World Alliance for Safer Health Care

SAVE LIVES
Clean Your Hands

All reasonable precautions have been taken by the World Health Organization to verify the information contained in this document. However, the published material is being distributed without warranty of any kind, either expressed or implied. The responsibility for the interpretation and use of the material lies with the reader. In no event shall the World Health Organization be liable for damages arising from its use. WHO acknowledges the Hôpitaux Universitaires de Genève (HUG), in particular the members of the Infection Control Programme, for their active participation in developing this material.

May 2009

Source: WHO (2009)

Figure 12.3 Hand hygiene technique with alcohol-based formulation

How to Handwash?

WASH HANDS WHEN VISIBLY SOILED! OTHERWISE, USE HANDRUB

 Duration of the entire procedure: 40–60 seconds

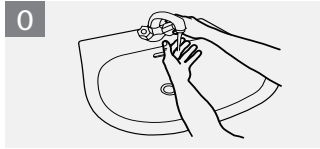

0 Wet hands with water

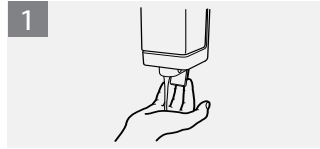

1 Apply enough soap to cover all hand surfaces

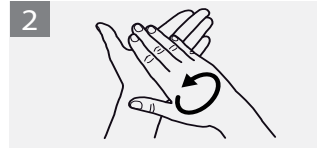

2 Rub hands palm to palm

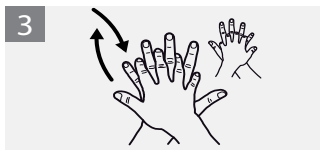

3 Right palm over left dorsum with interlaced fingers and vice versa

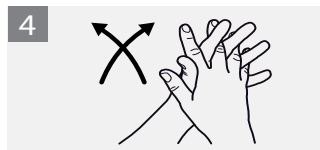

4 Palm to palm with fingers interlaced

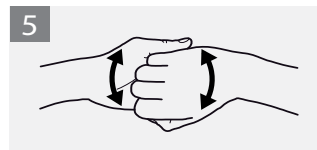

5 Backs of fingers to opposing palms with fingers interlocked

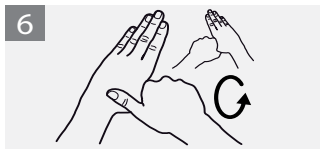

6 Rotational rubbing of left thumb clasped in right palm and vice versa



7 Rotational rubbing, backwards and forwards with clasped fingers of right hand in left palm and vice versa



8 Rinse hands with water

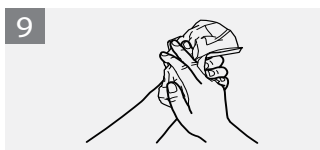

9 Dry hands thoroughly with a single use towel

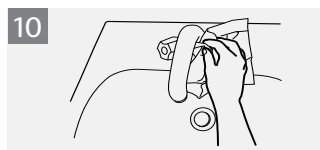

10 Use towel to turn off faucet

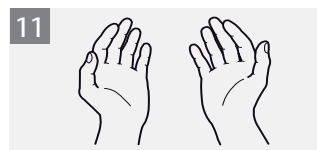

11 Your hands are now safe



World Health Organization

Patient Safety
A World Alliance for Safer Health Care

SAVE LIVES
Clean Your Hands

All reasonable precautions have been taken by the World Health Organization to verify the information contained in this document. However, the published material is being distributed without warranty of any kind, either expressed or implied. The responsibility for the interpretation and use of the material lies with the reader. In no event shall the World Health Organization be liable for damages arising from its use. WHO acknowledges the Hôpitaux Universitaires de Genève (HUG), in particular the members of the Infection Control Programme, for their active participation in developing this material.

May 2009

Source: WHO (2009)

Figure 12.4 Hand washing technique with soap and water

12.5 Measures for improving infection control

Infection control can be improved in three ways:

- avoiding wasteful practices
- using good infection-control practices
- using good cost-effective practices.

These are further detailed in Table 12.3.

Table 12.3 Ways to improve infection control

Eliminate wasteful practices that just increase costs	Use good, no-cost infection-control practices	Use good, low-cost infection control practices
Avoid: <ul style="list-style-type: none">• routine swabbing of health-care environment to monitor standard of cleanliness• routine fumigation of isolation rooms with formaldehyde• routine use of disinfectants for environment cleaning, e.g. floors and walls• inappropriate use of PPE in intensive-care units, neonatal units and operating theatres• use of overshoes, dust-attracting mats in the operating theatres, and intensive-care and neonatal units• unnecessary intramuscular and intravenous (IV) injections• unnecessary insertion of invasive devices (e.g. IV lines, urinary catheters, nasogastric tubes)• inappropriate use of antibiotics for prophylaxis and treatment• improper segregation and disposal of clinical waste.	You should: <ul style="list-style-type: none">• use aseptic technique for all sterile procedures• remove invasive devices when no longer needed• isolate patients with communicable diseases or a multidrug-resistant organism on admission• avoid unnecessary vaginal examination of women in labour• minimize the number of people in operating theatres• place mechanically ventilated patients in a semi-recumbent position.	You should: <ul style="list-style-type: none">• provide education and practical training in standard infection control (e.g. hand hygiene, aseptic technique, appropriate use of PPE, use and disposal of sharps)• provide hand-washing material throughout a health-care facility (e.g. soap and alcoholic hand disinfectants)• use single-use disposable sterile needles and syringes• use sterile items for invasive procedures• avoid sharing multidose vials and containers between patients• ensure equipment is thoroughly decontaminated between patients• provide hepatitis B immunization for health-care workers• develop a post-exposure management plan for health-care workers• dispose of sharps in robust containers.

PPE, personal protective equipment

12.6 Minimum approach to hygiene and infection control

Infection control is a team effort. Therefore, at a minimum, a multidisciplinary infection-control committee must be organized, comprising (but not limited to):

- a senior physician to provide leadership
- a clinical microbiologist

- an infection-control nurse
- an antibiotic specialist
- a director of environmental services.

The committee should set clear aims that are time specific and measurable, and that target a specific population of patients, location or employees. Aims could include implementing a hand hygiene programme, and implementing an environmental cleaning and disinfection programme.

In summary, the minimum approach to good hospital hygiene and infection control includes:

- setting modest aims;
- establishing baseline rates;
- implementing evidence-based interventions shown to be effective elsewhere;
- carrying out daily process surveillance (or clinical audit) throughout the project period to monitor compliance with the interventions by staff;
- measuring rates again at the end of the project period;
- if desired improvements have not occurred, analysing the reasons (e.g. poor compliance with the interventions), implementing necessary changes and repeating the cycle.

12.7 Desirable improvements to the minimum approach

Every hospital should launch the WHO-sponsored *Clean care is safer care* campaign as a matter of urgency. *Clean care is safer care* addresses an issue of universal relevance to patient safety aimed at reducing health-care-associated infections worldwide. The main plank of the campaign is the *Five moments for hand hygiene* tool.

This tool was developed from the *WHO guidelines on hand hygiene in health care* (WHO, 2009). The tool defines the key moments when health-care workers should perform hand hygiene. The tool is easy to learn, and is presented in clear language accompanied by simple descriptions. It presents a unified vision and sense of ownership, and is applicable to a wide range of settings. The WHO website provides more information.²¹

Key points to remember

- Numerous pathways exist for disease transmission to occur.
 - Numerous practices exist to stop disease transmission from succeeding.
 - Hand washing is a key component to breaking the chain of infection.
 - Clean equipment (by removing organic debris) before disinfecting.
 - Select disinfectants based upon the desired outcome.
 - Health-care waste streams, like patients, can harbour infectious agents and must be managed accordingly.
-

12.8 References and further reading

References

CDC (2003). Guidelines for environmental infection control in health care facilities: recommendations of CDC and the Healthcare Infection Control Practices Advisory Committee (HICPAC). *Morbidity and Mortality Weekly Report*, 52(RR-10):1–48.

Chiang CF et al. (2006). Hospital waste generation during an outbreak of severe acute respiratory syndrome in

²¹ See http://www.who.int/gpsc/tools/Five_moments/en

Taiwan. *Infection Control and Hospital Epidemiology*, 27(5):519–522.

Friedman C, Newsom W, eds (2011). *Basic concepts of infection control*, 2nd ed. Malta, International Federation of Infection Control (previously published as *Infection control: basic concepts and training*. International Federation of Infection Control, 2007, ISBN 978-0-9555861-0-1) (http://www.theific.org/basic_concepts/index.htm).

Garner, JS, the Hospital Infection Control Practices Advisory Committee (1996). *Guidelines for isolation precautions in hospitals*. Atlanta, Georgia, Centers for Disease Control and Prevention.

Parker MT (1978). *Hospital-acquired infections: guidelines to laboratory methods*. Copenhagen, World Health Organization Regional Office for Europe (European Series no. 4).

Siegel JD et al. (2007). *Guideline for isolation precautions: preventing transmission of infectious agents in healthcare settings*. Atlanta, Georgia, Centers for Disease Control and Prevention (<http://www.cdc.gov/hicpac/pdf/isolation/isolation2007.pdf>).

WHO (World Health Organization) (2007). *Aide memoire: standard precautions in health care*. Geneva, WHO (<http://www.who.int/csr/resources/publications/standardprecautions/en>).

WHO (2009). *WHO guidelines on hand hygiene in health care*. Geneva, World Health Organization (http://whqlibdoc.who.int/publications/2009/9789241597906_eng.pdf).

Further reading

Ayliffe GAJ et al. (1992). *Control of hospital infection. A practical handbook*, 3rd ed. London, Chapman & Hall.

Beck EG, Schmidt P (1986). *Hygiene im Krankenhaus und Praxis* [Hygiene in the hospital and in medical practice]. Berlin, Springer.

Block SS (2000). *Disinfection, sterilization, and preservation*, 5th ed. Philadelphia, Lea & Febiger.

CDC (Centers for Disease Control and Prevention) (2002). Guideline for hand hygiene in health care settings: recommendations of the Healthcare Infection Control Practices Advisory Committee and the HICPAC/SHEA/APIC/IDSA Hand Hygiene Task Force. *Morbidity and Mortality Weekly Report*, 51(RR-16).

Daschner F (1997). *Praktische Krankenhaushygiene und Umweltschutz* [Practical hospital hygiene and protection of the environment], 2nd ed., Berlin, Springer.

Mayhall CG (1996). *Hospital epidemiology and infection control*. Baltimore, Williams & Wilkins.

Mehtar S (1992). *Hospital infection control. Setting up with minimal resources*. Oxford, Oxford Medical.

Nizam D (2007). Simple measures save lives: an approach to infection control in countries with limited resources. *Journal of Hospital Infection* 65(S2):151–154.

Philpott-Howard JN, Casewell MM (1994). *Hospital infection control. Policies and practical procedures*. London, Saunders.

Russell AD, Hugo WB, Ayliffe GAJ (1992). *Principles and practice of disinfection, preservation and sterilization*, 2nd ed. Oxford, Blackwell.

Steuer W (1992). *Hygiene in der ärztlichen Praxis* [Hygiene in medical practice]. Stuttgart, Fischer.

Thofern E, Botzenhart K (1983). *Hygiene und Infektion im Krankenhaus* [Hygiene and infection in the hospital]. Stuttgart, Fischer.

Wenzel RP (1997). *Prevention and control of nosocomial infections*, 3rd ed. Baltimore, Williams & Wilkins.

13 Training, education and public awareness

Key questions to answer

What are the consequences of an absence of training?

What is the present availability of trained staff with knowledge of health-care waste management?

What information on health-care waste do medical and support staff need to know to do their job better?

When should training be started?

What preparations are needed for different types of training?

Who should take responsibility for organizing a training programme?

13.1 Importance of training and education

Training and capacity building of health-care staff are essential in the efforts to minimize the transmission of secondary infections. Staff training leads to a more informed workforce, which is the foundation for achieving higher standards of infection control. Knowledgeable staff can also help patients and visitors to understand their role in maintaining good hygiene, and to become more responsible for the wastes they produce.

The overall goals of training are to:

- prevent occupational and public health exposures to the hazards associated with health-care waste;
- raise awareness of the health, safety and environmental issues relating to health-care waste;
- ensure that health-care staff are knowledgeable about best practices and technologies for health-care waste management and are able to apply them in their daily work;
- foster responsibility among all health-care workers for health-care waste management.

Training and continuing education are integral parts of the health-care waste-management system. When health-care personnel are properly sensitized to the importance of waste management, they become advocates for best practices, and help to improve and sustain a good waste-management system. Importantly, training should be institutionalized and become part of the standard functions of the health-care facility. Training is therefore linked to health-care quality improvements, institutional policies and procedures, human resource development including staff performance evaluations, and facility organization to ensure that someone takes responsibility for the training programme. At the national level, minimum requirements for training in health-care waste management could be considered in national policies, as well as in health-care facility accreditation or licensing.

The availability of proper waste equipment, such as sharps containers and personal protective equipment, goes hand-in-hand with training. Nothing can be more frustrating than to train health-care workers in proper segregation methods when the health-care facility has inadequate or improper containers, thereby hindering the staff from putting their knowledge into practice. Hence, budgeting and procurement of equipment are also linked to training. Furthermore, the costs of training should be incorporated into the health-care facility's annual budget.

Training health-care personnel in implementing a waste policy is a central requirement if improvements to waste management are to be successful. However, training is not a goal in itself (training for the sake of training); rather,

it is a means to achieve a goal, such as behaviour change to improve waste-management practices. The training is successful if it leads to observable improvements in performance. For this reason, training is used in conjunction with creating a supportive environment, other forms of communication (e.g. posters, signs), incentives (e.g. awards and recognition to individuals), a means for personnel to provide input on improving practices, monitoring, reflective supervision, and corrective action.

13.2 Education and training of health-care personnel

13.2.1 Planning and implementation

For health-care facilities that do not have a training programme, one of the first steps is to obtain the support of the administration. This may be in the form of a facility-wide policy or approval for a pilot training programme in selected departments.

The development of a training programme can be facilitated by establishing core competencies related to health-care waste management. Core competencies are a set of knowledge, skills and attitudes that are essential for the effective performance of a job function. Core competencies establish a framework for training and education. Some national policies, licensing authorities or standard-setting bodies may already have minimum core competencies defined. The United Nations Development Programme's Global Healthcare Waste Project (Emmanuel, 2009) has examples of core competencies related to health-care waste management.

In health-care facilities that had initial training that was not sustained, an assessment of learning needs and why the programme was stopped could be conducted. Gaps in training should be identified to inform the development of a new programme. An assessment of organizational capacity for training is also important.

At a national or regional level, training programmes could be in the form of training of trainers. The training-of-trainers approach allows rapid capacity building and widespread training outreach because of its cascade effect, in which master trainers impart knowledge and skills to trainees, who then become trainers and who in turn train others. Some training-of-trainers programmes may not be successful, especially if trainers are not trained in both content knowledge and training skills. Certain individual traits are helpful for potential trainers; these include a personality that is outgoing, confident, well organized, open to constructive criticism, self-motivated, articulate and creative. Factors that could lead to failure include the trainer's inexperience or lack of in-depth knowledge, poor modelling by the master trainer, inadequate time to practise training skills among peers, a lack of follow-up by the master trainer, and no system of evaluation and feedback to help the trainers improve their programmes. If well-designed, planned and implemented, a training-of-trainers programme can be an efficient and effective approach.

The need for training can also be met if more medical, dental and nursing schools include health-care waste management in their courses. Health professional organizations and associations of hospitals can provide a service to their members by offering seminars and training programmes.

The following are recommended steps in the planning and preparation of a training programme. These steps are not in chronological order and are interrelated:

- Identify and prioritize the employees to be trained.
- Define the specific learning objectives for each target audience.
- Explore multiple training delivery options to maximize outreach, considering the work schedules of the participants (e.g. short 30-minute or 1-hour in-service training sessions once a week for several weeks; on-the-job coaching and mentoring; an intensive three-day workshop; self-paced study using printed materials or CDs; web-based or video-conference training; classes in an academic institution).
- Develop a detailed curriculum specifying the following for each session: topic, expected outcomes, duration, teaching/learning method, teaching/learning aids, participant assignment before the session (if any), facilitator/learner activities, assessment, and resources (see the example in Box 13.1).

- Incorporate pre-evaluation and post-evaluation of learners, evaluation of trainers, follow-up activities, and documentation into the training programme.
- Develop training content or adapt available training materials; tailor training content to specific target audiences.
- Identify potential trainers and build training skills.
- Develop a budget and secure funding.
- Explore incentives for training (e.g. training in collaboration with a health professional society or academic institution that can award certificates, academic credits or professional credentials).
- Send out announcements and build interest in the training programme among target participants.

Box 13.1 Example of a training set-up

Workshop topic: health-care waste classification and segregation

Expected outcomes – participants will be able to:

- list the major classifications and characteristics of health-care waste
- define what comprise sharps waste and its contribution in disease transmission
- demonstrate basic segregation of health-care waste items
- demonstrate appropriate containerization of health-care waste.

Teaching and learning method:

- lecture and discussion
- small-group discussion
- individual participant activity.

Teaching and learning aids:

- projector
- laptop computer
- PowerPoint presentation
- board and chalk, or flip chart paper and marker pens
- matrix of examples of different waste items designed to get the participants to think about the corresponding segregation requirements
- surrogate waste (uncontaminated waste items made to look like real waste, such as bandages smeared with tomato sauce to look like blood) and different types of colour-coded waste containers.

Participant assignment before the session:

- each participant reads the excerpt from the country's regulations on the health-care waste-classification system and segregation requirements.

Facilitator and learner activities:

- The trainer presents the country's classification system, characteristics of different types of health-care waste, and segregation requirements for health-care waste.
- Group activity 1: the trainer shows a matrix listing different types of waste and facilitates a discussion with the class about which containers each type of waste should be placed in.
- Group activity 2 (small group): the trainer divides the participants into groups of three or four people and gives each group different types of surrogate waste items, including sharps. Each group is then asked to place their waste items in the proper containers.
- Homework: each participant writes guidelines on classification and segregation specific to their service or department.

Source: adapted from the United Nations Development Programme GEF Global Healthcare Waste Project, *Sample master curriculum for healthcare waste management training* (<http://gefmedwaste.org/downloads/Sample%20Master%20Curriculum%20for%20HCWM%20Training.pdf>)

13.2.2 Employees to be trained

All hospital personnel, including senior medical staff and managers, should be able to communicate the benefits of health-care waste management. They should be prepared to undertake training and be convinced of the health, occupational safety, economic, environmental and regulatory advantages. Achieving this outcome should strengthen the participation and collaboration of other personnel in training activities.

Separate training activities can be designed for different categories of health care personnel:

- hospital managers and administrative staff responsible for implementing regulations on health-care waste management;
- medical doctors;
- nurses, nursing assistants and allied professions;
- cleaners, porters, auxiliary staff and waste handlers.

Since action to improve waste management has to take place throughout a health-care facility (notably managers, medical staff producing the waste, porters and waste handlers), training all these categories of personnel is equally important. Medical doctors can be trained through short senior staff workshops and general staff through longer formal seminars. The training of waste handlers and nurses managing medical areas should be more thorough and focus on practical procedures. Nurses and waste handlers are key personnel to instil a disciplined approach in the day-to-day management of wastes. Experience has shown that their training should be practical and undertaken at their own place of work or somewhere similar. In some countries, this approach can be supplemented with seminars or courses run by public health and training institutions.

13.2.3 Content of education programmes

Training should highlight the roles and responsibilities of each member of staff and how they contribute to the broader management policy to achieve good waste practices. Neither a local initiative nor a more extensive national policy for health-care waste can be effective unless the training purpose is explained, the expected benefits to recipients are clear, and the means of delivering training are flexible enough to be tailored to regional and local customs and sensibilities.

Staff education programmes should include:

- information on, and justification for, all aspects of the health-care waste policy;
- information on potential infection risks posed by health-care waste;
- information on the role and responsibilities of each staff member to follow waste-management procedures;
- technical instructions on the application of waste-management practices relevant to particular types of work by some medical or support staff;
- information on monitoring, record keeping and maintenance of equipment.

One of the best ways of learning is through practice. Hands-on training by small groups of personnel should be considered, whenever appropriate. Testing the participants at the end of training by means of recalling procedures, measuring their ability to demonstrate techniques, and asking factual questions, often provides an incentive for learning. It also allows the course organizers to assess the level of knowledge acquired by participants and to adjust the teaching methods used in future training.

Trainers should have experience in teaching and coaching young and new staff. To be able to speak with authority, they should be familiar with the hazards and practices of health-care waste management. They should also have some practical experience in the correct handling of waste.

13.2.4 Follow-up and refresher courses

Periodic repetition of courses will provide an opportunity to instruct new employees, and “refresher” courses for existing employees can remind them of practices and inform about changes or new responsibilities. Follow-up training is instructive for trainers, too, indicating how much information has been retained by course participants and for revising the scope of future refresher courses.

13.2.5 Training responsibility

The waste-management officer, in cooperation with the infection-control officer, is typically given responsibility for all training related to health-care waste. The waste-management officer should ensure that staff at all levels are aware both of waste-management methods in use, and of their own responsibilities and obligations. A record should be kept of all training sessions and the members of staff who completed each course successfully. The content of training programmes should be periodically reviewed with the infection-control officer and, if possible, regulators and waste contractors, and updated where necessary.

Medical staff working in clinics and similar places with smaller sources of health-care waste should also receive training. This could be offered centrally by larger health-care facilities or by regional public health organizations.

13.3 Implementation of a training course

13.3.1 The training package

A national training package could be developed by the government agency responsible for health care or the environment. Alternatively, a certified programme in health-care waste management could be delivered by public health or training institutions through locally prepared courses or by home study and distance learning, or even by tailoring training materials already available from an international organization, a development agency or another country. The package should be suitable for various types of health-care facilities, including government, private, teaching, general hospitals, polyclinics, health centres, health-care research institutions and clinical laboratories. It could also be useful for more general educational establishments and for organizations that provide services for the health-care waste sector.

A standard, national training package should be liberally illustrated with drawings, diagrams, photographs, posters and slides to demonstrate the concepts of infection control and safe waste management. These should reflect workplace situations and provide examples of measures that have been (or will be) implemented. Where it is likely that waste handlers and other workers are illiterate, diagrams and photographs should be used to demonstrate procedures.

Example training packages

Among others, the following training sets (Box 13.2) have been developed on behalf of the World Health Organization (WHO) and the United Nations. The detailed programme design for the development of training tools is outlined as case studies in Annex 2.

Box 13.2 Training tools examples (World Health Organization-related)

1. Distance learning set

Indira Gandhi National Open University (IGNOU), New Delhi, India, in active collaboration with World Health Organization (WHO) South-East Asia Region, has developed and launched a six-month certificate programme in health-care waste management through distance learning. This programme is already running successfully in India, Bangladesh and Nepal. In 2009, the Ministry of Health in Mongolia signed a memorandum of understanding with IGNOU to offer this programme for its health-care staff in Mongolia. Bhutan and Sri Lanka have initiated steps to offer this certificate programme in their countries. The certificate programme aims at capacity building of health-care professionals and workers in safe and informed management of health-care waste. The programme package includes the following components:

- eight blocks of self-learning material (this course material has already been edited and vetted by WHO)
- a six-day contact programme in identified hospitals, which function as study centres
- project work
- field visits
- teleconferencing session, including audio and video cassettes
- two assignments.

A good feature of this certificate course and programme is that it provides standardized, good-quality training over a relatively short six-month period.^a

2. Three-day basic course (WHO Euro)^b

WHO Europe Region has commissioned a three-day basic course on health-care waste management. The main objective of the training is to educate selected staff to become the responsible person for waste management in their health-care facility. The participants learn how to plan, set up and independently run the waste-management system of a health-care institution. After the training, the employees should know how to minimize nosocomial infections and occupational accidents related to health-care waste. They should also know how to react in case of emergencies and injuries, and how to use basic waste-management planning tools.

The modular training package consists of the tutorial, a comprehensive handbook on health-care waste with background information and aid materials (e.g. forms, stickers, posters), and slide presentations (25 to 35 slides per training module). The modules are presented by an experienced health-care waste trainer. The training includes simulations, questions, exercises and practical demonstrations to make the learning enjoyable and to encourage a high level of knowledge retention. Onsite visits and monitoring exercises are also organized.

3. UNDP GEF Global Healthcare Waste Project's training modules^b

The United Nations Development Programme's Global Environment Facility (UNDP GEF) Global Healthcare Waste Project, in cooperation with WHO, Health Care Without Harm and the University of Illinois-Chicago School of Public Health, has developed a set of modules for health-care waste-management training. The modules, comprising slide presentations on specific topics, are supplemented by an instructor's guide and evaluation tools. Separate modules can be selected and modified for different target audiences. The training approach combines experiential and participatory training techniques with clearly defined expected outcomes.

a See <http://www.ignou.ac.in/ignou/aboutignou/school/sohs/programmes/detail/230/2>

b See <http://www.gefmedwaste.org>

13.3.2 Selection of participants

The ideal number of participants on a training course is 20 to 30. Larger groups may make effective discussions and exercises difficult to operate. Courses should be aimed at all categories of personnel. Discussions may be easier and more useful if the group is composed of trainees from various disciplines (e.g. supervisors, medical and nursing staff, laboratory staff, engineers, ancillary staff), or at least contain one or two medical assistants and nurses. It may also be valuable to include senior administration staff and heads of departments in certain training groups to demonstrate their commitment to the waste-management policy and to show the relevance of the policy to all personnel of health-care facilities.

13.4 Training health-care waste handlers

The minimum training for health-care waste handlers should include:

- information on the techniques and risks associated with the handling of health-care waste
- procedures for dealing with spillages and other accidents
- instructions on the use of protective clothing.

The training needs will obviously depend on the type of waste operations performed, but may include specific topics such as operation of treatment technologies and waste transportation. Boxes 13.3–13.7 list the points that should be stressed when training waste handlers.

13.4.1 Health-care personnel

Training should provide an overview of the waste-management policy and its underlying rationale, and information on practices relevant to the targeted group of trainees. Waste segregation is a key element in waste-management training for personnel who provide health care. Box 13.3 lists precautions that should be emphasized.

Box 13.3 Training health-care personnel

- Great care should be taken if needles have to be removed from syringes.
- Hazardous and general waste should not be mixed. Segregation is the key to safe health-care waste management.
- No attempt should be made to correct waste-segregation mistakes by removing items from a bag or container, or by placing one bag into another of a different colour.
- Nursing and clinical staff should ensure that adequate numbers of bag holders and containers are provided for the collection, and subsequent onsite storage, of health-care waste in the medical areas, clinics, theatres and other areas where waste is generated. These receptacles should be located as close as practicable to the common sources of waste generation in a medical area.

13.4.2 Cleaning staff

Topics to be covered may include the waste-management policy, health hazards, onsite transportation, storage, safety practices and emergency response. Awareness of the need for safety may decrease with time among staff who routinely handle health-care waste, which will, in turn, increase the risk of injury. Periodic short informal reminders and refresher training are suggested. Box 13.4 lists the key points relevant to training for cleaning staff.

Box 13.4 Training cleaning staff

- Check that waste-storage bags and containers are sealed. No bags should be removed unless properly labelled and securely sealed to prevent spillages.
 - Bags should be picked up by the neck only. They should be put down in such a way that they can again be picked up by the neck for further handling. Manual handling of waste bags should be minimized whenever possible.
 - Waste bins should be cleaned after removing the filled waste bag, and a new bag should be placed into the bin immediately.
 - Waste bags should not touch the body during handling, and collectors should not attempt to carry too many bags at one time. No more than two is a sensible limit.
 - When handling and transporting waste bags or containers is completed, seals should again be checked to ensure they are unbroken.
 - To avoid puncture or other damage, waste bags should not be thrown or dropped.
 - Mismanagement of sharps waste may occasionally puncture the side or bottom of a polypropylene container; the container should therefore be carried by its handle and should not be supported underneath with the free hand.
 - Bags for hazardous health-care waste and for general waste should not be mixed, but should be segregated throughout handling and transport. Hazardous waste should be placed only in specified storage areas.
 - Appropriate cleaning and disinfection procedures should be followed in the event of accidental spillage. Any such incident should be reported immediately to the responsible member of staff.
 - Protective clothing (gloves, apron, sturdy shoes) should be worn during all waste-handling operations.
 - Raw food supplies such as vegetables and fruits should not to be unloaded or stored near waste-storage areas.
-

13.4.3 Staff who transport waste

A health-care facility itself may carry out the transportation of waste or it may contract this operation to an “authorized” waste transporter. In many countries, waste is transported to a central treatment or disposal site. Drivers and waste handlers should be aware of the nature and risks associated with the waste they transport. In particular, transport staff should be trained to be able to carry out all waste-related procedures in accordance with instructions, and without help from others. Box 13.5 summarizes the key points relating to training for staff who transport waste.

Box 13.5 Training waste-transport staff

- Follow correct procedures for handling, loading and unloading colour-coded waste bags and containers.
 - Be aware of the correct procedures for dealing with spillages or other accidents, and be aware of established, usually written, instructions for these procedures.
 - Use protective clothing and strong footwear at all times.
 - Ensure the availability of dedicated waste-collection vehicles, spare plastic bags, protective clothing, cleaning tools and disinfectants to deal with any spillage that occurs during loading, transport or unloading.
 - Document health-care waste inside a health-care facility and, if carried offsite, be aware of how a consignment note system operates to track waste from its point of generation to its final place of disposal.
-

Managers at a health-care facility should liaise with the transport contractor to ensure that the waste-collection crew is well trained. Untrained personnel should not be allowed to handle hazardous health-care waste. They would be a danger to others and to themselves.

13.4.4 Treatment plant operators

Qualified operators are needed for incinerators, autoclaves and microwave and other treatment facilities. If no qualified operators are available, managers of health-care facilities should arrange to train an adequate number of personnel.

Treatment plant operators should have received technical education to at least secondary school level. Box 13.6 lists the tasks they should be specifically trained in.

Box 13.6 Training treatment plant operators

- General functioning of the treatment facility, including heat recovery and flue-gas cleaning technologies, where appropriate.
 - Health, safety and environmental implications of treatment operations.
 - Technical procedures for operation of the plant.
 - Recognition of abnormal or unusual conditions.
 - Emergency response, in case of equipment failures and alarms.
 - Maintenance of the plant and record keeping.
 - Surveillance of the quality of ash and emissions, according to the limits laid down in permits, laws or plant specifications (for incinerator operators).
-

Further details for training treatment plant operators are given in Box 13.7.

13.4.5 Landfill operators

In many middle- and lower-income countries, “safe burying” will continue to be used for the disposal of health-care waste until there is sufficient capacity for incineration or other treatment method. Training landfill operators is important for limiting the risks associated with buried health-care waste, in relation to both scavenging and the quality of groundwater. Landfill operators should therefore be trained in similar issues outlined for treatment plant operators in Box 13.6, above.

Box 13.7 Issues to address when training treatment plant operators

Waste handling

- Procedures for receiving, handling and storage of health-care waste.
- Loading of waste into the treatment unit.

Operation of the plant

- Operation of the plant equipment, including start-up and shut-down procedures.
- Operation and testing of control, alarm and instrumentation systems, including corrections when necessary.
- Optimum operating temperatures, pressures, concentrations of emissions, speeds, flows and maintenance of correct conditions.
- Detection of defects or malfunctions (following written procedures) and servicing.
- Safe removal of residues, ashes and treated material.

Maintenance

- Daily, weekly, monthly, periodic and annual tests, inspection, cleaning, lubrication, replacement and replenishment of consumables (e.g. thermocouples). Special attention should be paid to major components of the installation and reporting the need for repairs when necessary.

Note that, recently, biomedical engineers have been recruited by provincial governments in some countries to oversee and monitor the efficiency of plant operators.

Safety measures and emergency response

- Use of protective equipment and maintenance of personal hygiene.
- Fire precautions.
- Procedures for emergency response, including manual operation of the plant under emergency conditions, dealing with spillages, accidents and other incidents.
- Contingency plans for alternative operations during breakdown or planned maintenance.

Administrative procedures

- Licence conditions and regulations governing emissions and ways of working.
 - Record keeping.
 - Reporting of spillages, accidents and other incidents, and suggesting changes.
 - Health risks related to health-care waste.
 - Hazards related to sorting health-care waste, which should not be practised by landfill operators, informal recyclers or the general public.
 - Minimizing the handling of health-care waste by drivers and treatment and disposal site operators.
 - Use of protective equipment and personal hygiene.
 - Safe procedures for landfilling the wastes.
 - Updating procedures for emergency response.
-

13.5 Integrating training with public education on risks of health-care waste

Promotion of safe and sensible waste handling and disposal is relevant both to users of health-care facilities and to the wider community as one approach to achieve a better understanding of health public. A training and public awareness programme should contain two aspects. The first is to create awareness and foster responsibility for good hygiene among all workers, patients and visitors at health-care facilities. The public awareness programme can go further and explain how good health-care waste management protects public health. The second aspect is to inform the public in general about the risks from poor hygiene and health-care practices, with particular regard to people living or working in close proximity to health-care facilities, families of patients treated at home, and scavengers working at disposal sites.

Various methods can be used to promote public education on health-care waste. Commonly used approaches include the following:

- Poster exhibitions can be used to educate about health-care waste issues, such as the risks involved in reusing syringes and hypodermic needles or the infection-control benefits of waste segregation and treatment.
- Medical staff can explain to new patients and visitors their personal responsibilities to help maintain good hygiene and safe waste management. This may be difficult to achieve with people who have entrenched views, and face-to-face discussion should be supplemented with diagrams, posters and leaflets.
- Information signs and pictograms can be used in hospitals, at strategic points such as waste-bin locations, giving instructions on waste segregation. Signs should be explicit, using diagrams, illustrations and consistent colour coding to convey the message to a broad audience, including illiterate people and those with a lower educational capacity.

For maximum effectiveness, all information should be displayed or communicated in an attractive manner to hold people's attention and increase the likelihood they will remember the important messages to be conveyed by an information campaign.

In medical areas, general health-care waste bins should be easily accessible for patients and visitors, and signs should explain clearly what they should do with other categories of waste.

Growing awareness of health and environmental hazards has increased across the world, leading to higher public demand for information and guidance on these issues. Demand has intensified in some countries due to a rise in the prevalence of HIV/AIDS, viral hepatitis B and other well-publicized illnesses. Health-care facilities should set an example to society by demonstrating that they are managing their waste in a manner designed to protect health and the environment.

13.6 Minimum approach to training, education and public awareness

With the help of suitably developed information, education and communication material, a half- to one-day training programme can be carried out. Such training programmes can be designed separately for the waste handlers and health-care staff in medical areas and their supervisors.

13.7 Desirable improvements to the minimum approach

13.7.1 Improvements to the minimum approach

The minimum approach could be quickly improved by providing refresher training at periodic intervals (e.g. every six months). This refresher training should be provided inside the health-care facility by respected nursing and support staff. These members of staff should be regarded as "key trainers" who, in turn, should be helped to keep up to date with improvements in health-care waste management. This could take the form of on-the-job discussions and demonstrations to groups of staff in their medical areas.

13.7.2 Improvements to more advanced approaches

More advanced approaches to training would mean the development of a mixed selection of learning methods and opportunities in health-care facilities. These could also take the form of certified education and training through distance learning, as well as web-based and classroom-taught courses.

To summarize, field visits, informal discussions, action plan development, present situation analyses and on-the-job coaching are effective training tools. Lecture and classroom teaching, and unstructured or discussion groups with limited staff participation, tend to be less effective. A receptive attitude from training participants is a critical factor to produce a good learning environment. When a vibrant learning environment is created, a high level of personal retention of knowledge is achieved.

13.8 References and further reading

Reference

Emmanuel J (2009). *Core competencies related to healthcare waste management*. Geneva, GEF Global Healthcare Waste Project, United Nations Development Programme.

Further reading

Agarwal AG, Singh R (2005). *Understanding and simplifying bio-medical waste management: a training manual for trainers*. India, Toxics Link.

Berman A, Nelson C (2005). *Training health workers in the management of sharps waste*. Seattle, PATH (<http://www.path.org/publications/detail.php?i=1143>).

Emmanuel J, Pratap P, Nickels L (2010). *Sample master curriculum for healthcare waste management training*. Geneva, GEF Global Healthcare Waste Project, United Nations Development Programme.

Furjanic SW, Trotman LA (2000). *Turning training into learning: how to design and deliver programs that get results*. New York, Amacom.

MoHFW (Ministry of Health and Family Welfare) (2007). *Infection management and environment plan, policy framework*. New Delhi, Government of India.

MoHFW (2007). *Infection management and environment plan – guidance manuals for community health care, primary health care and sub-centres*. New Delhi, Government of India.

OSHA (Occupational Safety & Health Administration) Office of Training and Education (1996). *Presenting effective presentations with visual aids*. Washington DC, United States Department of Labor (<http://www.osha.gov/doc/outreachtraining/htmlfiles/traintec.html>).

Pieper U, Kühling J-G (2009). *3-day basic training on healthcare waste management in CIS countries*. Denmark, World Health Organization Regional Office for Europe.

Prüss A, Townend WK (1998). *Teacher's guide: management of wastes from health-care activities*. Geneva, World Health Organization (http://www.who.int/injection_safety/toolbox/Teachersguide1.pdf).

14 Health-care waste management in emergencies

Key questions to answer

What are the issues to address for a rapid assessment?

What are the main hazards in an emergency situation?

What disposal systems should be used?

14.1 Guiding principles

Natural disasters and conflicts, by their nature, are highly disruptive and dangerous events. Their consequences are unpredictable, and it is inevitable that many essential public services will be interrupted. Health-care facilities, public health and municipal services, such as waste management, may totally or partially cease due to destroyed buildings, damaged equipment, dislocation of staff and blocked roads. In such situations, all forms of wastes including hazardous health-care wastes remain uncollected and untreated. It is inevitable that wastes will accumulate, and serious environment and health hazards (e.g. hepatitis B and C) may affect communities. Therefore, measures need to be taken to remove wastes as soon as possible after an emergency. The purpose is to reduce the proximity of people to accumulated wastes and so reduce the potential for disease transmission.

The first step in the management of health-care waste in emergencies is to carry out a rapid initial assessment. This will produce the information required to restart interim waste services where they are needed. A coordinated response from aid and local bodies, bringing together whatever resources may be available, is the best way to reduce public health risks. More detailed assessments can be conducted during the later phases of the disaster-management cycle. Experience has shown that areas and regions with experience of running well-managed health-care waste systems typically have better responses in emergencies. However, a satisfactory level of readiness for an early response is achieved when “emergency preparedness and contingency” plans are prepared and practised, particularly in countries susceptible to recurrent emergencies.

At regional and national levels or in disaster-prone areas, an “interagency group” comprising national or international organizations should prepare contingency plans. In recent years, international agencies have adopted a “cluster” approach, whereby one agency takes the lead in managing the emergency response on behalf of the international community. Typically, the World Health Organization (WHO) leads the health cluster and the United Nations Children’s Fund (UNICEF) leads the water and sanitation cluster. Both clusters are involved in health-care waste management in an emergency situation. Through its involvement in many emergencies at hospitals and clinics, WHO has focused its efforts on providing assistance to the management of wastes generated by health-care activities.

The management of wastes generated by emergency medical care activities can vary during the three phases of the disaster-management cycle, namely initial *assessment*, immediate *response* and the longer term *recovery phase*.

14.2 Phases for the safe management of health-care waste in emergencies

14.2.1 Phase one: rapid initial assessment

Rapid assessments immediately following a disaster or other emergency are designed to be swift and to inform emergency responders about critical and immediate needs. An initial rapid assessment is likely to be unrefined and should be updated as more data become available. Box 14.1 provides information about the issues to address in the rapid assessment phase. Assessment teams need to be given clear terms of reference and be aware of the type of information and recommendations that they are expected to produce. Generic terms of reference for conducting a rapid initial assessment are given in Box 14.2. Finally, Box 14.3 lists the key issues to bear in mind when collecting information in emergencies.

Box 14.1 Rapid initial assessment

General information

- Nature and history of the emergency.
- Organization carrying out the assessment.
- Name and position of assessors.
- Dates of the assessment.
- Location of the affected area.
- Logistical resources available.
- Government involvement.
- Existing potential donors.
- Other organizations working in the area, including current and planned activities.
- Institutions and nongovernmental organizations providing emergency medical care.
- Existing policies, regulations or guidelines on health-care waste management.
- Locations and nature of emergency medical care interventions (in tents, field hospitals, mobile health-care facilities, non-damaged hospitals and health-care centres, health-care facilities outside of the affected area).

Demographic data

- Total population in the affected area.
- Approximate number of affected people.

Geographical information

A sketch should be produced and the following features identified and located:

- Location and type of existing operational medical care activities.
- Location and type of existing operational waste-treatment and disposal facilities.
- Burial or cremation sites.
- Location of emergency dumping of health-care waste.
- If possible, groundwater water levels near the locations of the operational health-care operations.

General description of the management of health-care waste in the affected area

Together with the help of national counterparts, write a full description of the current capabilities to manage health-care waste (from points of generation to final disposal) in the affected area.

- The categories of health-care wastes generated by medical care activities.
 - Provide any information about health-care waste quantities. If none exists, make a rough estimation.
 - Describe the process of health-care waste handling in the location of the emergency medical activities.
 - Describe the type and number of waste-related equipment available for managing health-care waste.
 - Explain how health-care waste is disposed.
 - Identify any sites near the emergency health-care activities for controlled burial of health-care waste.
 - Identify who is involved in the handling and disposal of health-care waste.
 - Identify financial resources allocated for handling and disposal of health-care waste.
 - Describe any reported injuries related to health-care waste (e.g. sharps injuries).
-

Box 14.2 Generic terms of reference for conducting a rapid initial assessment

The expert is to undertake the following:

- Meet with the chairperson of the health cluster and ask them whether the contingency plan of the health sector (if any) includes emergency preparedness measures related to health-care waste management. Subsequently, refer to the emergency preparedness arrangements and determine appropriateness to the prevailing situation.
- Collect **rapidly** general and geographical information and data (if any) about the affected area (see Box 14.1) and any public or private waste-related services that may still be functioning.
- Visit as many facilities as possible providing emergency medical care activities in the affected area and collect **rapidly** the general and technical information listed below. Where possible, use recognized rapid assessment methods or forms from the World Health Organization or other international agencies.
- General information:
 - Name of the medical care activities, responsible institution and sponsor.
 - Location of the facility in the affected area.
 - Types of emergency medical care activities provided.
 - Whether there are financial resources allocated for health-care waste handling and disposal.
 - Who is responsible for managing health-care waste and the availability of staff for handling and disposal of collected waste.
- Technical information:
 - What categories of health-care wastes are generated by the emergency medical care activities?
 - Is there any information about health-care waste quantities? If not, make a rough estimation.
 - Describe the process of health-care waste handling in the location of the emergency medical activities.
 - What type and number of logistics or equipment are used for the safe management of health-care waste?
 - How is health-care waste being disposed of at present?
 - Is there a site near the medical care activities for burial of health-care waste?
 - Are there any injuries related to health-care waste (e.g. sharps injuries)?

Note: recommendations for rapid improvement of the situation should preferably be implemented by the expert who would conduct the rapid initial assessment. Tasks that may be added to the above terms of reference are as follows: (1) Recommend practical solutions, including a list of needed equipment (and related costs) and develop a plan of action to safely manage health-care wastes (see phase two in section 14.2.2 of this chapter), taking into consideration available human and financial resources as well as existing national policies and guidelines in the area of health-care waste, and occupational and public health; (2) provide a list of additional improvements or adjustments in case resources become available.

Personnel carrying out assessments are likely to provide initial advice and awareness-raising activities simultaneously. However, a pragmatic balance must be found between the need to act quickly and the need to gather sufficient information to ensure assistance is effective, appropriate to the problems found and sustainable into the future.

Box 14.3 Issues to remember when collecting information in emergencies

- Collect information from as many sources as possible to reduce bias and inaccuracies.
- Be aware of local conditions so as not raise unrealistic expectations.
- Use the data collected as evidence to inform the decisions that must be made.
- Keep good records of what has been learned and from whom.
- Situations change rapidly in an emergency, and the solutions proposed should be robust and flexible.
- Get a good interpreter if working with people who speak a different language.

More detailed assessments are required during the later disaster-management phases as the needs and capabilities of local communities and public organizations evolve. The purpose is to prepare the contributors to the wider relief effort to change over from short-term initial response activities to longer term rehabilitation.

14.2.2 Phase two: emergency response

Based on the rapid initial assessment, a simple action plan with clear roles and responsibilities for individuals and emergency response organizations (international bodies, national authorities, civil society) can be developed and resources allocated from the aid effort for implementation. Rapid identification of collaboration and coordination between individual organizations should take place during this phase. Countries with pre-established contingency plans on health-care waste management should activate them, with a special focus on the process of coordination and collaboration with international, municipal and public organizations.

As a basic starting point and to avoid sharps injuries, health-care waste generated by emergency medical care activities (in tents, field hospitals, mobile hospitals) should be segregated using a “two-bin solution” – that is, sorting waste into used sharps and non-sharps wastes (including general wastes and infectious, pathological and pharmaceutical residues). The two bins should be kept segregated until final disposal.

The purpose of health-care waste management in an emergency is to avoid wastes from being scattered indiscriminately around medical buildings and their grounds and reduce the likelihood of secondary infections. All non-sharps wastes, without exception, should be collected in medical areas in rigid containers, such as plastic buckets with a cover, to prevent waste items from being exposed to disease transmission by contact by hand, airborne particles and flying insects. Containers and covers should be washed and disinfected daily after being emptied. Reuse of rigid waste containers after disinfection with a chlorine (0.2%) solution may be the most practical option to introduce quickly in an emergency situation, and is low cost at a time when resources for better forms of waste segregation and storage may be scarce. Sharps wastes should be stored safely in puncture-proof and leak-proof containers.

Burial of non-sharps and sharps wastes in pits or trenches may be considered as a pragmatic option in emergency situations. Burning of health-care waste is less desirable, but if it is genuinely the only realistic option in an emergency it should be undertaken in a confined area (burning within a dugout pit, followed by covering with a layer of soil).

The following preventive measures can also be implemented during an emergency response phase to reduce public and occupational health risks (in a short emergency response period, some activities, such as awareness raising, may not be implemented):

- Provide hepatitis B vaccination to all health-care staff and waste handlers.
- Encourage hand hygiene (washing, preferably followed by disinfection).
- Use gloves for handling health-care waste.
- Raise the awareness of staff about simple post exposure prophylaxis in the event of an occupational injury (e.g. needle-stick injury).
- Contain and promptly clean up spillages of infectious materials and disinfect quickly to avoid pathogen transmission.
- Disinfect body fluids before their discharge.
- Conduct onsite awareness-raising activities (whenever possible) to remind health-care staff about occupational exposures and the safe practices for managing health-care waste.

As an emergency response progresses and more aid resources become available, the management of health-care waste can be improved by establishing a three-bin system (Table 14.1).

Table 14.1 Segregation of health-care waste in emergencies

Waste category	Typical waste items	Type of container	Colour or mark/sign
Non-sharps wastes	Infectious, pathological wastes and some pharmaceutical and chemical residues	Leak-proof container or plastic bag in a holder	Yellow or special mark or sign
Used sharps	Syringes with needles, sutures, blades, broken glass	Leak- and puncture-proof sealable container, box or drum bearing the word "contaminated sharps"	Yellow or special mark or sign
General waste	Similar to municipal wastes, not contaminated by hazardous substances	Container or plastic bag in a holder	Black or special mark or sign

Segregated waste should be kept separated until final disposal. General waste should follow a municipal waste disposal route, if available, and sharps and non-sharps wastes should be treated and disposed of using the best available practices based on the minimum options described in the preceding chapters of this handbook.

Segregation and packaging

All containers and bags should be filled to three quarters of their capacities to avoid spillage and kept covered to prevent casual access by people or disease vectors. Should colour coding of plastic bags and containers not be possible, signs or marks can be put on containers to differentiate between hazardous health-care waste and general waste. Segregated waste should be regularly removed and safely stored to reduce the risk of transmission of pathogens and improve general standards of cleanliness and hygiene in medical areas.

If plastic bags are not available, containers for non-sharps wastes should be washed and disinfected after being emptied.

Body parts should be safely stored and disposed of according to local culture and customs.

Collection

Exclusively allocated carts or trolleys with lids should be used to collect and transport health-care waste. Carts should be regularly cleaned and disinfected.

Highly infectious wastes (e.g. laboratory wastes and wastes from persons with contagious diseases) should be collected quickly and carried to a single, secure central storage area; on no account should collected waste be left anywhere other than at a central storage point.

Storage

Segregated waste should preferably be stored in specific restricted areas. The storage area should be a locked room or guarded enclosure. If this is not available, large containers with lids may be used for temporary storage of segregated waste and should be placed in restricted areas to minimize contact with people and animals. Mark the storage area with the biohazard symbol, or put a sign or mark that is understood locally to differentiate between hazardous and non-risk wastes.

Treatment and disposal

Gradual change and improvement in waste-treatment and disposal practices are normal as resources and confidence of local decision-makers returns. Should resources not be available, minimal treatment and disposal practices should continue to be used as follows:

- onsite burial in pits or trenches;
- disposal in special cells in municipal dumping sites;
- burning in pits and then covering with soil;
- incineration in low-cost double-chamber incinerators;
- encapsulation of sharps wastes or small quantities of pharmaceuticals followed by onsite burial or burial in special cells in municipal dumping sites;
- incineration in high-temperature industrial incinerators (provided that there is a safe means of transportation);
- disinfection of infectious and sharps wastes with a small autoclave (when resources are available); non-sharps disinfected wastes should join the general waste stream.

The following waste categories should not be incinerated:

- mercury thermometers (preferably collect for mercury recovery);
- pressurized containers (safe burial in pits);
- polyvinyl chloride (PVC) plastics such as intravenous sets, catheters and PVC containers for sharps (safe burial in pits);
- vials of vaccines (safe burial in pits);
- anatomical wastes or body parts (safe burial in pits).

The following is a summary related to some minimum treatment and disposal options.

Onsite burial in pits

Dig a pit 1–2 m wide and 2–3 m deep. The bottom of the pit should be at least 2 m above the groundwater. Line the bottom of the pit with clay or permeable material. Construct an earth mound around the mouth of the pit to prevent water from entering. Construct a fence around the area to prevent unauthorized entry. Inside the pit, place alternating layers of waste, covered with 10 cm of soil (if it is not possible to layer with soil, alternate the waste layers with lime). When the pit is within about 50 cm of the ground surface, cover the waste with soil and permanently seal it with cement and embedded wire mesh (Figure 14.1).

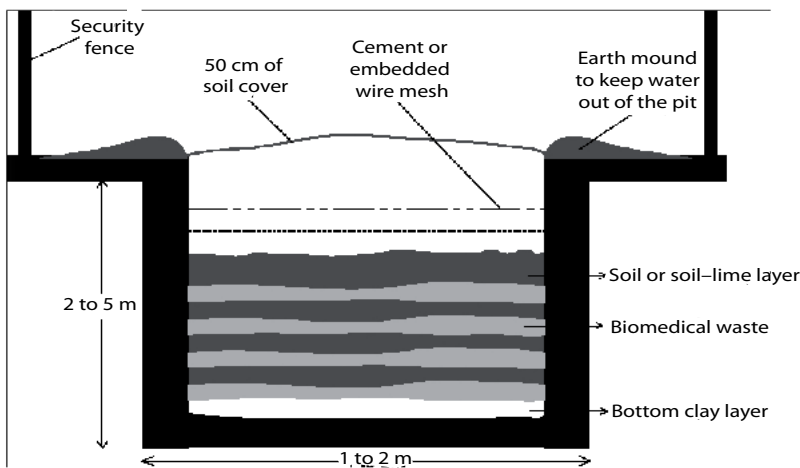

Figure 14.1 Construction of a pit for onsite waste burial

Burial in special cells in dumping sites (if available in the affected area)

Cells to contain waste can be used when burying waste in dumping sites. The cell should be at least 10 m long and 3 m wide, and 1–2 m deep (Figure 14.2). The bottom of the cell should be at least 2 m above the groundwater. The bottom of the cell should be covered by soil or a material with low permeability. The waste in the cell should be covered immediately with 10-cm layers of soil to prevent access by people or animals (in diseases outbreaks, preferably spread lime on waste before covering with the soil). It is strongly recommended that health-care waste be transported in a safe manner to minimize public exposure to biocontaminated wastes.



Figure 14.2 Special cells or trenches for disposal of biocontaminated wastes in a municipal dumping site (10 m long, 3 m wide and 2 m deep)

Low-cost double-chamber incinerators

Double-chamber incinerators may reach a temperature of about 800 °C with a residence time of more than one second in the second chamber to kill pathogens and break down some of the particulates in the outlet gases. The incinerators should be built at a convenient distance away from buildings. Such incinerators need to be heated with paper, wood or dry non-toxic waste (small quantities of kerosene may be added, if available) before adding infectious wastes.



Source: WHO/EMRO Regional Centre for Environmental Health Activities (CEHA)

Figure 14.3 Double-chamber incinerator in a health-care centre dumping site

Encapsulation

Place sharps wastes or pharmaceutical wastes in hard containers, such as metal drums, and add an immobilizing material, such as cement, bituminous sand or clay. When dry, the drum or container can be sealed and buried in local landfill or a pit in a health-care facility.

Disposal of pharmaceuticals and expired drugs

During emergencies, large quantities of pharmaceuticals are often donated as part of humanitarian assistance. However, in some circumstances (e.g. when there is inadequate stock management, lack of space or unwanted quantities of pharmaceuticals), large quantities of pharmaceuticals may not be used and therefore should be disposed of safely. Table 14.2 shows the methods for safe disposal of unwanted pharmaceuticals.

Table 14.2 Summary of pharmaceutical disposal methods in and after emergencies

Disposal method	Type of pharmaceutical	Comments
Return to donor or manufacturer, transfrontier transfer for disposal	All bulk waste pharmaceuticals, particularly antineoplastics	Usually not practical – transfrontier procedures may be time consuming
Highly engineered sanitary landfill	Limited quantities of untreated solids, semi-solids and powders PVC plastics	Immobilization of waste pharmaceuticals is preferable before disposal
Engineered landfill	Waste solids, semi-solids and powders PVC plastics	Immobilization of solids, semi-solids and powders is preferable before disposal
Open, uncontrolled, non-engineered dump	Untreated solids, untreated semi-solids and untreated powders	As last resort, untreated solids, semi-solids and powders must be covered immediately with municipal waste Immobilization is preferable before disposal Not for untreated controlled substances
Immobilization: waste encapsulation or inertization	Solids, semi-solids, powders, liquids, antineoplastics and controlled substances	Immobilization – not applicable Chemical decompositions are not recommended unless special expertise and materials are available
High-temperature incineration with temperature more than 1200 °C	Solids, semi-solids, powders, antineoplastics and controlled substances	Expensive, particularly for purpose-built incinerators Use of existing industrial plants may be more practical
Medium-temperature incineration with two-chamber incinerator, minimum temperature of 850 °C	In the absence of high-temperature incinerators, solids, semi-solids, powders and controlled substances	Antineoplastics best incinerated at high temperature
Burning in open containers	Packaging, paper and cardboard	As last resort Not acceptable for PVC plastics or pharmaceuticals
Sewer or fast-flowing watercourses	Diluted liquids, syrups, intravenous fluids, small quantities of diluted disinfectants (supervised)	Not recommended for antineoplastics, undiluted disinfectants or antiseptics
Chemical decomposition	NA	Not recommended unless special expertise and materials are available Not practical for quantities of more than 50 kg

NA, not applicable; PVC, polyvinyl chloride
Source: WHO (1999)

Tips for establishing a good drug-management system are as follows (JSI and WHO, 2003):

- estimation of drugs based on health service use and standard treatment regimens
- a well-functioning stock inventory control system
- practising “first expiry first out” (“fefo”) and “first in first out” (“fiffo”) for drugs stocked
- coordination with health institutions
- negotiation with suppliers for the possible return of drugs that are about to expire.

14.2.3 Phase three: recovery phase

The recovery phase can be characterized as a longer term programme of assistance to return an affected community to a normal situation similar to that which existed before the disaster – or, potentially, better. Whatever the prevailing situation (or level of development) before the emergency, improvements in health-care waste management may be possible to introduce using new resources provided by government or international donors during the emergency phase.

As resources become available, a more detailed assessment can be conducted for planning and fundraising for future improvements, and for setting priorities in the affected area. WHO has produced health-care waste-management assessment tools designed for this purpose.²² Box 14.4 summarizes the key things that must be addressed during the third (recovery) phase of waste management in emergencies.

Box 14.4 Key points to address during a recovery phase

- Existing procedures and practices of health-care waste management.
- Responsibility for the management of health-care waste.
- Presence of an infection-control committee to oversee improvements and training.
- Dedicated equipment for storage, collection, and onsite and offsite transportation of health-care waste.
- Availability of onsite and offsite health-care waste-treatment facilities.
- Availability of onsite and offsite disposal facilities.
- Level of health-care staff awareness about the risks associated with health-care waste.
- Staff health protection (protective clothing, vaccination).
- Financial aspects related to health-care waste management and associated infection-control procedures, and a means to sustain funds to operate waste management in the future.

The results of the assessment and the identified needs and priorities are the starting point for ensuring that a sustainable approach to health-care waste management is created after an emergency. Start by preparing simple, locally applicable action plans to define the improvements to be achieved, and gradually improve these action plans whenever the resources become available. Detailed central strategic plans may prove difficult to prepare on a realistic timescale, and a region or country may not have the capacity to implement them in the aftermath of an emergency. It is important that all planned activities respect the principles of prevailing national legislation and policies, and fit into a national plan for emergency response, where they are already available.

14.3 Contingency planning and emergency preparedness

Health-care waste should be included in contingency plans for the health sector. If it is integrated, there is a stronger likelihood that the contingency arrangements for health-care waste would be put into operation in an organized manner. Countries, particularly those with recurrent periods of emergencies, are strongly encouraged to have a

²² See http://www.who.int/water_sanitation_health/medicalwaste/hcwmtool/en/index.html

contingency plan for the safe management of health-care waste to increase the effectiveness, appropriateness and timeliness of responses.

At health-care facility level, action plans on health-care waste management should include temporary measures to apply during emergency situations.

The contingency plans should address the following questions:

- What standards will be used to guide a response?
- What are the current capacities of the agencies or organizations to respond?
- What initial assessment arrangements are needed?
- What actions will be taken as an immediate response to the situation?
- Who does what and when? Who is coordinating and leading?
- What resources would be needed?
- How will information flow between the various levels (local and national)?
- Have specific preparedness actions be agreed on and practised?

Contingency planning needs to be seen as a continuing process that is regularly reviewed and updated to ensure that all partners are familiar with their various roles, responsibilities and actions to be undertaken. Contingency plans should be in line with existing national policies and legislation.

14.4 References and further reading

References

John Snow, Inc./DELIVER in collaboration with the World Health Organization. *Guidelines for the storage of essential medicines and other health commodities*. 2003. Arlington, Va.: John Snow, Inc./DELIVER, for the US Agency for International Development. (<http://apps.who.int/medicinedocs/pdf/s4885e/s4885e.pdf>)

WHO (World Health Organization) (1999). *Guidelines for safe disposal of unwanted pharmaceuticals in and after emergencies*. Geneva, World Health Organization (available at http://www.who.int/docstore/water_sanitation_health/Documents/Healthcare_waste/Unwantedpharm/unwantpharm.doc).

Further reading

Inter-Agency Standing Committee Reference Group on Contingency Planning and Preparedness (2001). *Inter-agency contingency planning guidelines for humanitarian assistance, recommendations to the inter-agency standing committee*. New York, United Nations (<http://reliefweb.int/sites/reliefweb.int/files/resources/3A55E4CD762756ECC1256C5A004B7793-iasc-guidelines-nov01.pdf>).

PAHO (Pan American Health Organization) (1982). *Environmental health management after natural disasters: a study guide*. Washington DC, Pan American Health Organization (<http://helid.digicollection.org/en/d/Jops05e>).

PAHO (1999). *Humanitarian assistance in disaster situations: a guide for effective aid*. Washington, DC, Pan American Health Organization (available at <http://helid.digicollection.org/en/d/Jh0185e/>).

Rushbrook P, Zghondi R (2005). *Better healthcare waste management: an integral component of health investment*. Amman, World Health Organization Centre for Environmental Health Activities, World Bank (<http://www.healthcarewaste.org/resources/documents/page/1/>).

Secretariat of the Basel Convention, UNEP (United Nations Environment Programme), WHO (World Health Organization) (2005). *Preparation of national healthcare waste management plans in sub-Saharan countries: guidance manual*. Geneva, World Health Organization.

WHO (World Health Organization) (2006). *Guidelines for the safe disposal of expired drugs*. Amman, Jordan, WHO CEHA (http://www.emro.who.int/images/stories/pakistan/documents/pak_documents/Guidelines_for_Expired_Medicines.pdf).

WHO EMRO (World Health Organization Eastern Mediterranean Regional Office) (2007). *WHO emergency handbook for the eastern Mediterranean region*. Cairo, World Health Organization Eastern Mediterranean Regional Office (<http://www.who.int/hac/techguidance/tools/manuals/en/index.html>).

WHO EURO (World Health Organization Europe Regional Office) (2000). *Starting health care waste management in medical institutions: a practical approach*, Copenhagen, World Health Organization Europe Regional Office.

WHOPAK (World Health Organization Regional Office for Pakistan) (2005). *Guidelines for the safe disposal of expired drugs*, Islamabad, World Health Organization Regional Office for Pakistan.

WHO SEARO (World Health Organization Regional Office for South-East Asia) (2004). *Practical guidelines for infection control in health care facilities*. Kuala Lumpur, World Health Organization Regional Office for South-East Asia (http://www.who.int/water_sanitation_health/emergencies/infcontrol/en/index.html).

WHO SEARO (2005). *Four steps for the sound management of healthcare waste in emergencies*. Kuala Lumpur, World Health Organization Regional Office for South-East Asia (<http://helid.digicollection.org/en/d/Js13462e/>).

Wisner B, Adams J (2002). *Environmental health in emergencies and disasters: a practical guide*. Geneva, World Health Organization (http://www.who.int/water_sanitation_health/hygiene/emergencies/emergencies2002/en).

Zghondi R (2002). *Basic steps in the preparation of healthcare waste management plans for healthcare establishments*. Amman, World Health Organization Centre for Environmental Health Activities (<http://www.k4health.org/toolkits/implants/basic-steps-preparation-health-care-waste-management-plans-health-care>).

15 Future issues

15.1 Changing patterns of disease

Box 15.1 Key points relating to changing disease patterns

Issues

- Novel and multidrug-resistant organisms will arise continually and unpredictably.
- Disease patterns will shift, and disease vectors will move with alterations in climate and population movements.
- Health-care waste production during future pandemics will be highly variable and will require flexibility in access to waste operations.
- Waste workers and knowledge of waste engineering are often not included in emergency plans, which could undermine the availability of waste collection and treatment capacity.

Response options

- Research and information dissemination on methods to prevent spread of new disease organisms from health-care wastes.
- Research and information dissemination on practices and technologies to inactivate persistent disease organisms to ensure more effective waste treatment (e.g. prions, *Clostridium difficile*).
- National and international rapid response plans for pandemics and the establishment of institutional and legal frameworks to implement plans promptly.

15.1.1 Emerging diseases and multidrug-resistant organisms

As microorganisms evolve, new strains will continually emerge to cause human disease. Influenza H5N1, Creutzfeldt–Jakob disease, West Nile virus, severe acute respiratory syndrome, human immunodeficiency virus (HIV), Lyme disease, *Escherichia coli* 0157, Ebola virus disease and Marburg virus have mostly transferred from animals into humans. Among the most important diseases are those becoming increasingly resistant to the established medical treatments. These include extremely drug-resistant tuberculosis, methicillin-resistant and vancomycin-resistant *Staphylococcus aureus*, and malaria (chloroquine-resistant *Plasmodium falciparum*, and strains that are resistant to the antifolate combination drugs and to atovaquone). *Clostridium difficile* too has recently caused much concern as a resistant nosocomial infection (Loo et al., 2005).

Waste-treatment practices may need to be adapted to ensure that novel organisms are inactivated properly. Standardized test strips containing heat-resistant bacterial spores are assumed to demonstrate that processes to inactivate the spores will also be effective with other pathogens. However, some pathogens – such as prions – are difficult to inactivate. Testing protocols, including test strip design, need to be updated regularly in the light of new data on pathogen resistance.

15.1.2 Pandemics

Pandemics have always occurred periodically. They may be catalysed by factors including the increase in international travel and movement of populations or disease vectors. Much concern currently centres on the expected spread of malaria-carrying *Anopheles* mosquitoes to higher latitudes and elevations as climate change progresses. Figure 15.1 illustrates the predicted spread of malaria by 2050. The Malaria Atlas Project publishes data on the distribution of the malaria parasite, and data on the distribution of *Anopheles* were added from June 2009.²³

23 See <http://www.map.ox.ac.uk>

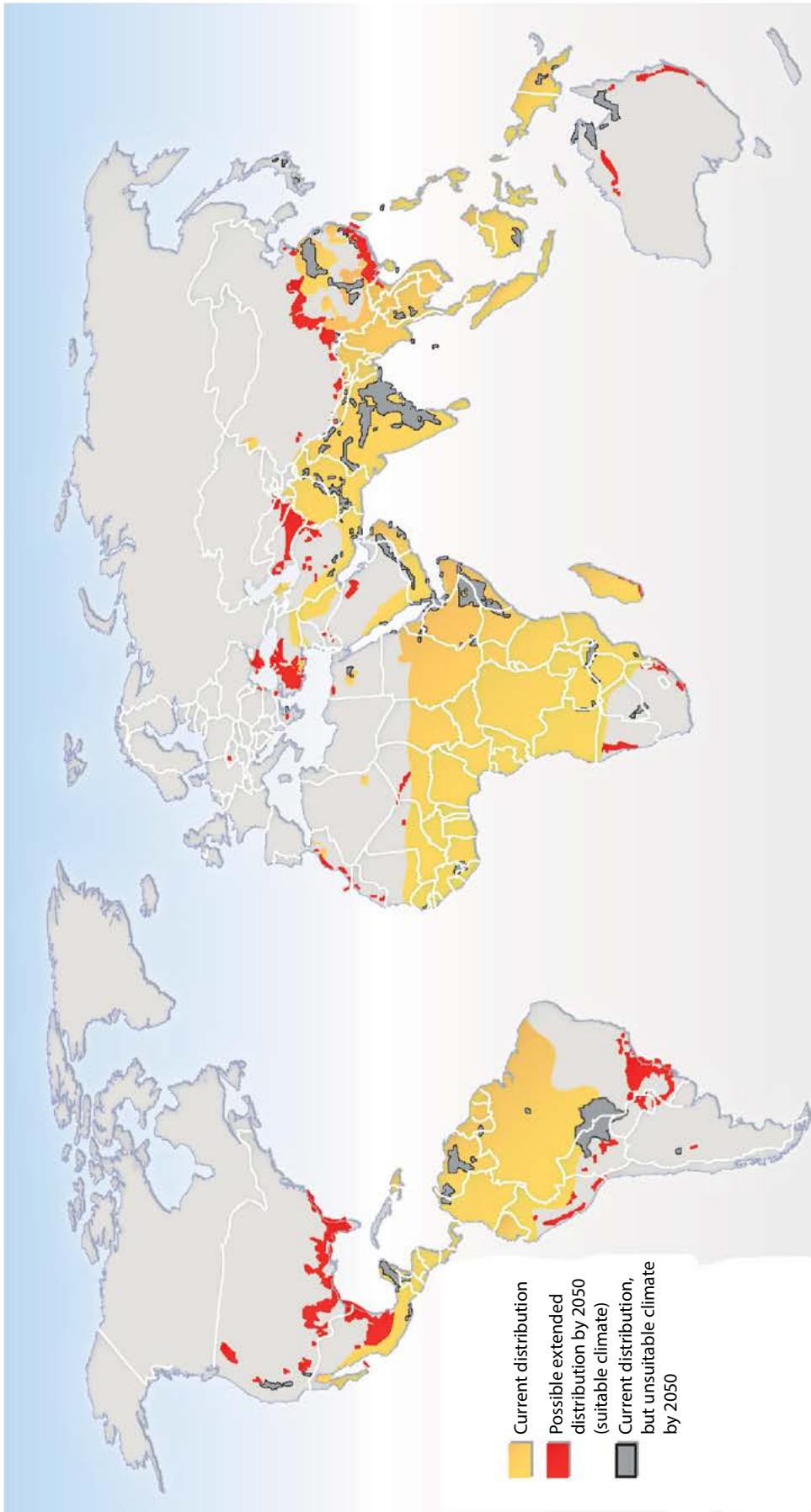

Source: Rogers & Randolph (2000)

Figure 15.1 Anticipated extension in the range of malaria in 2050

It is generally assumed that the amount of health-care waste will increase during pandemics, but if non-emergency medical operations and other treatments are postponed, the amount of wastes may be lower. The mode of transmission will be another significant factor. If a pandemic is spread by contact, even general waste from medical areas may potentially have to be classified as infectious health-care waste.

Where a vaccine is available, the quantity of sharps waste and empty vials will increase significantly. Fortunately, these wastes are comparatively easy to store and so should not create an insurmountable health-care waste problem, unless produced in underdeveloped regions. Any increase in vaccination waste may be partially offset by a reduction in routine injections.

The status of waste-management staff should be considered. Unlike health workers, they are generally not included in lists of essential workers who should be prioritized for vaccination. Consequently, there may be significant staff shortages and subsequent loss of capacity for waste-management staff. This would be most acute where health-care waste treatment and disposal are conducted at centralized plants away from health-care facilities.

In their contingency plans to address medical emergencies, countries should include the use of health-care waste engineering advice, realistic transportation and disposal arrangements, and the regular vaccination of waste workers. This is a prudent approach to maintaining a sufficient level of public health protection through prompt waste removal and processing during an emergency.

15.2 Environmental issues

15.2.1 Climate change

Box 15.2 Key points relating to climate change

Issues

- Sea level rise and increased flooding will affect routine waste-collection and treatment services and access to sites.
- Heatwaves and other extreme weather events will increase the burden on health-care facilities, increase waste production, and lengthen storage times for wastes before disposal.
- Fuel and energy costs will increase.
- Geographical disease patterns will change.
- Greater health consequences will result from an increasing likelihood of more large-scale population movements.

Response options

- Avoid siting waste-handling and disposal sites on locations that are vulnerable to flooding.
- Ensure extra clearance during planning and design between subsurface constructions (landfills, septic systems, composting pits) and the subsurface water table.
- Consider the possibility of being cut off from waste-collection services by floods when planning waste-storage and treatment needs for remote facilities.
- Plan for reduced storage periods during heatwaves.
- Install temperature controls in waste-storage areas, noting that extreme weather events may result in power failures.
- Select low-energy waste-treatment options.
- Install renewable energy sources where possible.
- Reduce overall resource requirements through waste-minimization practices.
- Develop contingency plans for impacts likely at facility, regional, national and international levels.

Climate change is likely to affect all aspects of life, and waste management is no exception. Gradual climatic trends and extreme weather events can disrupt services in the short term and affect long-term capacity requirements. Waste-disposal sites are often built on marginal sites, such as marshlands, flood plains and coastal areas, and many

may become increasingly vulnerable to flooding where average sea and river levels rise or more frequent extreme weather events inundate the land. Shorter duration weather changes, such as seasonal floods and heatwaves, may be particularly problematic in rural areas, where resilience in waste-collection systems may be lower. This can be countered by decentralizing waste treatment and increasing storage capacity, as well as undertaking contingency or continuity planning at the facility and national levels. Fuel and power costs are predicted to rise, and power shortages may become more common, even in developed countries. Planners should promote the adoption of low-energy technologies wherever possible. Installation of renewable energy generation capacity, particularly at remote installations, would reduce vulnerability.

15.2.2 Other environmental issues

Box 15.3 Key points relating to environmental issues

Issues

- There is a need to reduce toxic chemicals in wastewater and in other emissions from health-care waste disposal.
- Overuse of antimicrobials increases pathogen resistance.
- The availability of authorized landfill capacity is decreasing, and the costs of operation are increasing.
- Environmental protection requirements and costs will increase.

Response options

- Prioritize pollution prevention over pollution control and avoid the use of toxic materials wherever possible.
- Improve wastewater treatment and avoid disposing of chemicals to the sewer.
- Avoid overuse of microbial chemicals, especially silver triclosan and glutaraldehyde.
- Replace chlorine as a disinfectant with hydrogen peroxide, ozone and ultraviolet alternatives.

The list of pharmaceuticals, other hospital-derived chemicals and disinfection by-products present in wastewater and the environment is increasing. Their impacts on human and ecosystem health vary, but are becoming more widely understood.

In Sweden, the government, universities and pharmaceutical industry are working together to assess and publish toxicological and environmental data, including persistence and bioaccumulation data for pharmaceuticals. This may well form the basis of a Europe-wide information scheme, and would allow purchasing departments to select products that have reduced environmental effects. The emerging science of “green chemistry” may also lead to new drugs being designed to have the desired curative effects while minimizing adverse environmental impacts.

Overuse of antimicrobials can simultaneously drive bacterial resistance and cause pollution. Glutaraldehyde, triclosan and silver are among the best known. Silver is now found in many medical devices, soaps, textiles, furnishings and construction materials targeted at hospitals. However, some bacteria rapidly build up resistance to silver by a mechanism that could also make them resistant to antibiotics, particularly the beta-lactams.

Resistance can also build up in bacteria in sewage treatment works and the wider environment if they are polluted with antimicrobials released from products. The only way to avoid these twin problems is through the segregation and treatment of wastes containing these antimicrobials, or their recovery from wastewaters. Since this is currently not practised and is unlikely to be feasible in the near future, use of these products should be kept to a minimum.

Chlorine-based disinfectants are widely used. However, chlorine can cause pollution through reacting with organic chemicals in liquid wastes to create toxic organochlorines. If materials such as infected plastics have been soaked in chlorine before incineration, the amount of chlorinated dioxins and furans produced will be elevated. Alternatives that can be equally or even more effective as disinfectants include hydrogen peroxide or ozone, either alone or in combination with ultraviolet light.

Pressure on landfill disposal is increasing in most countries, resulting in higher costs and decreased availability of licensed sites. Nevertheless, this creates incentives for waste minimization and treatment technologies.

15.3 Waste technology

Box 15.4 Key points relating to waste technology

Issues

- Little independent information is available on new waste-treatment technologies.
- Many products are not recyclable.
- Increased use of disposables will increase waste production.
- Some products (e.g. polyvinyl chloride [PVC], broken mercury thermometers) produce toxic emissions if incinerated.
- Technologies for low-income or remote regions need further development.

Response options

- Improve information dissemination for an informed debate on technology evaluations.
 - Set standards for waste treatment that relate to the level of microbial inactivation required.
 - Phase out mercury and PVC products used in health care.
 - Replace disposable products with reusable and recyclable options wherever it can be achieved without affecting patient care or worker safety.
 - Design new products for easier reuse and recycling.
 - Improve segregation of wastes so that each waste stream is sent to the most appropriate waste-treatment system.
-

The use of more complex medical procedures and the continuing trend towards single-use products in medical practice will lead to marked changes in the composition of waste. Using single-use products would necessitate disposal of the device itself and its packaging, neither of which may be recyclable. Increases in waste volumes can be guarded against by selecting reusable products where possible without compromising patient care or worker safety. Using products made of non-halogenated, recyclable materials, and avoiding excessive or non-recyclable packaging, is beneficial.

New and environmentally friendly technologies for health-care waste treatment include microwave and ozone for sterilizing, and alkaline hydrolysis and supercritical water oxidation for treating chemical and pharmaceutical wastes. Their implementation is hampered by cost and sometimes a reluctance by decision-makers to invest in technologies without a history of successful operation. There is also a lack of independent testing (both microbial inactivation and chemical emissions) or reliable capital and operating cost data. Another factor limiting the widespread implementation of these technologies is the paucity of models available for smaller facilities and those in remote areas.

Controlling pollution through technological means is a costly process and costs will inevitably rise as national and international pollution control legislation is tightened. Avoiding pollution through upstream measures such as better design of products will be more cost-effective. Procurement policies should favour products that are reusable or recyclable, are non-toxic and have a lower environmental impact when disposed of.

15.4 Social, cultural and regulatory changes

Box 15.5 Key points relating to social, cultural and regulatory changes

Issues

- The Stockholm Convention and other regulations may restrict incinerator use.
- Hazardous chemicals will be increasingly tightly regulated.
- New designs of medical equipment (e.g. retractable syringes, digital thermometers) are more costly than established products.
- Pressure on health-care services will increase as urban populations increase.
- There will be increasing globalization of medical device manufacture and procurement.

Response options

- Develop and implement non-incinerator technologies.
- Build capacity for technology transfer and knowledge sharing.
- Encourage health-care providers to cooperate to bulk purchase improved designs of medical products that are less expensive to dispose of.
- Build research collaborations to design and promote new environmentally beneficial products for the health-care sector.

As countries develop economically, populations tend to gravitate to the cities, increasing the pressure on all types of infrastructure. According to United Nations statistics, at the end of 2008, half the world's population was living in urban areas; this will rise to 70% by 2050.²⁴ The movement to the cities is likely to be exacerbated by climate change, as people may be driven off the land by drought, flooding or other changes that cause the failure of previously stable environments and agricultural systems. This will also increase the possibility of conflict and cross-border migration and exert pressure on disposal systems. These scenarios should be included in both development and emergency planning.

The Stockholm Convention aims to eliminate pollution from persistent organic pollutants, including dioxins and furans, which are produced by the combustion process in health-care waste incinerators. As implementation of the convention progresses, use of small-scale incinerators may reduce, and the monitoring and enforcement of emissions limits may further increase costs of incineration. Capacity-building plans should consider alternatives, such as autoclaving of infectious waste, which may become cheaper in the future.

Regulations are also tightening on the use and disposal of mercury-containing products, PVC, diethylhexyl phthalate (DEHP), pharmaceuticals, hazardous wastes and scrapped electronic equipment. In the future, "extended producer responsibility" legislation may make more product and waste producers legally responsible for ensuring the proper disposal of many types of waste.

The range of alternatives to medical products that pose elevated pollution risks during disposal is increasing, while the cost of many is decreasing. For example, more PVC- and DEHP-free devices are being brought to market. The price of mercury-free electronic thermometers and retractable syringes has decreased significantly, and syringe manufacturers are redesigning their products to make them more easily recyclable. Careful procurement can reduce the effort and expense of waste disposal. Improved information technology also makes it easier for decision-makers to identify and source the best available technologies from across the world.

Health-care systems can collaborate locally and nationally through "cross-government category management". These are consortia of organizations that combine their efforts to bulk purchase medical goods and services to achieve advantageous prices and adopt new products. This can stimulate markets for new products. Supplier and customer fora, and collaborations among health-care providers, manufacturers and waste-disposal experts on new product design, should be encouraged.

²⁴ See <http://www.un.org/esa/population/unpop.htm>

Health-care waste management currently suffers in many areas from a lack of attention by decision-makers and a lack of funding. Hopefully, this lack will be remedied as the health and environmental benefits of proper treatment are better appreciated. Minimization of the amount and toxicity of waste should take ever greater priority at all stages of the medical product design, manufacture, procurement, use and disposal cycle. At the same time, more recycling of non-hazardous wastes and the wider use of efficient and less polluting waste-disposal practices should reduce the impact on the environment and wider community health, and maintain protection from transmission of infections.

15.5 References and further reading

References

Loo VG et al. (2005). A predominantly clonal multi-institutional outbreak of *Clostridium difficile*-associated diarrhea with high morbidity and mortality. *New England Journal of Medicine*, 353(23):2442–2449; erratum in 2006, *New England Journal of Medicine*, 354(20):2200.

Rogers DJ, Randolph SE (2000). The global spread of malaria in a future, warmer world. *Science*, 289(5485):1763–1766.

Further reading

Engl J (2008). Introduction to the MAP *Anopheles* project. *New England Journal of Medicine*, 353(23):2442–2449; erratum in 2008, *New England Journal of Medicine*, 354(20):2200MAP. Revised 11 February 2008.

A1 Contributors to the first edition

The valuable contributions made by the following individuals to the production of the first edition of this handbook are gratefully acknowledged:

C Bartone	World Bank, Washington, DC, United States of America (reviewer)
AD Bhide	National Environmental Engineering Research Institute, Nagpur, India (reviewer)
M Castegnaro	International Agency for Research on Cancer, Lyon, France (author and reviewer)
E Cole	DynCorp, Durham, NC, United States of America (author and reviewer)
J Christen	Swiss Centre for Development Cooperation in Technology and Management (SKAT), St Gallen, Switzerland (reviewer)
G Ducl	Fondation Hygie, Geneva, Switzerland (reviewer)
BR Durand	Ministry of Health, Paris, France (author and reviewer)
M Giannoni	Bonnard & Gardel, Geneva, Switzerland (author and reviewer)
A Gur	World Health Organization Centre for Environmental Health Activities, Amman, Jordan (reviewer)
S Hansel	Central Pharmacy, Lapeyronnie Hospital, Montpellier, France (author)
P Harteman	Public Health Laboratory, Nancy, France (author and reviewer)
H Kitawaki	Faculty of Regional Development Studies, University of Toyo, Toyo, Japan (resource person)
G Linsley	Division of Radiation and Waste Safety, International Atomic Energy Agency, Vienna, Austria (author)
M Manciaux	University of Nancy, Nancy, France (resource person)
STW Miaw	Division of Radiation and Waste Safety, International Atomic Energy Agency, Vienna, Austria (author)

H Ogawa	World Health Organization Regional Office for the Western Pacific, Manila, Philippines (reviewer)
JC Pospisilik	World Health Organization Regional Office for South-East Asia, New Delhi, India (reviewer)
G Reybrouck	University Hospital, Louvain, Belgium (author)
A Roth	International Solid Waste Association, Netherlands (reviewer and resource person)
D Saw	Waste management consultant, Penang, Malaysia (author and reviewer)
S Shirato	Japanese Society for Medical Waste Research, Tokyo, Japan (resource person)
F Siem Tjam	Department of Health Systems, World Health Organization, Geneva, Switzerland (reviewer)
MH Sportouch	Central Pharmacy, Lapeyronnie Hospital, Montpellier, France (author)
C Struck	Ingenius, Berlin, Germany (reviewer)
E Tikhomirov	Department of Communicable Disease Surveillance and Response, World Health Organization, Geneva, Switzerland (reviewer)
W Townend	Environmental Agency, London, England (author and reviewer)
M Wilson	Environmental Protection Agency, Washington, DC, United States of America (resource person)
SP Wong	World Health Organization Regional Office for Africa, Brazzaville, Congo (reviewer)
F Zepeda	World Health Organization Regional Office for the Americas/Pan American Sanitary Bureau, Washington, DC, United States of America (reviewer)

The World Health Organization thanks all institutions and individuals who have provided information and helped to make this handbook possible. Particular thanks are due to the contributions to the first edition made by the International Agency for Research on Cancer, the International Atomic Energy Agency, the International Solid Waste Association, the United States Environmental Protection Agency, the Japanese Society for Research on Medical Waste, and the Swiss Corporation for Appropriate Technology.

A2 Example training programmes in health-care waste management

This appendix provides further information on three examples of training programmes in health-care waste management.

A2.1 IGNOU six-month certificate by distance learning

A distance-learning course in health-care waste management is offered globally by Indira Gandhi National Open University (IGNOU), New Delhi, India. This six-month course — the Certificate Programme in Health Care Waste Management — was developed in collaboration with the World Health Organization South-East Asia Region (WHO-SEARO).

The course aims to equip different health-care professionals, workers, nongovernmental organizations and other stakeholders with skills to manage health-care waste effectively and safely. The course is useful for doctors, nurses, paramedics, health managers and other health-care professionals. The course is offered as a multimedia package consisting of print material in the form of booklets called blocks, audiovisual materials, teleconferencing, radio-counselling, and providing hands-on training to the learners throughout a six-day contact period.

In the contact period, the learners are invited to the programme study centres in India, and to partner institutions in other countries. The package has eight theory blocks, a project and a programme guide. The learners are evaluated through regular assessments, projects and end-of-term examinations.

Table A2.1 shows the detailed programme design of the IGNOU/WHO-SEARO six-month certificate program.

Table A2.1 Programme of the Certificate Programme in Health Care Waste Management

Course code	Title	Credits ^a
BHM-001	Fundamentals: Environment and health, health care waste management regulation	4
	Block 1: Understanding our environment	1
	Unit 1: Introduction to the environment	
	Unit 2: Environmental pollutants	
	Unit 3: Interrelationship of environment and health	
	Unit 4: Waste management	
	Block 2: Health care waste definitions	1
	Unit1: Definitions, types and categories of waste	
	Unit 2: Principles of health care waste management	
	Unit 3: Handling health care waste	
	Block 3: Need for sound health care waste management	1
	Unit1: Impact of health care waste on our environment	
	Unit 2: Impact of health care waste on human health	
	Unit 3: Safety methodology, worker safety and precautions	
	Block 4: current status of health care waste management in South-East Asia Region countries	1
	Unit 1: Rules and legislations	
Unit 2: Regulatory mechanism		
Unit 3: Current status in India, Thailand, Indonesia, Sri Lanka, Bangladesh		
Unit 4: Current status in Bhutan, DPR Korea, Timor Leste, Maldives, Myanmar, Nepal and Mongolia		
BHM-002	Health care waste management: concepts, technologies and training	6
	Block 1: Practical aspects of health care waste management	2
	Unit 1: Managerial and administrative aspects	
	Unit 2: Integrated infection control management	
	Unit 3: Disinfection and transportation	
	Unit 4: Capacity building, training and monitoring	
	Block 2: Systems and technologies in health care waste management	2
	Unit 1: Systems options	
	Unit 2: Treatment and disposal of health care waste: burn technologies	
	Unit 3: Treatment and disposal of health care waste: non-burn technologies	
	Unit 4: Innovative concepts and possibilities	
	Block 3: Health care waste management and emerging issues	1
	Unit 1: Managing waste water from health care facilities	
	Unit 2: Management of waste from immunizations	
	Unit 3: Occupation and patient safety	
	Unit 4: Success stories	
Block 4: Training manual for waste handlers	1	
BHM-001	Project	4

^a In IGNOU's distance-learning programmes, the study hours are measured in a credit system. One credit is equivalent to 30 learning hours.
Source: see <http://mohfw.nic.in/NRHM/IMEP.htm>

A2.2 WHO-Euro three-day basic course

WHO Europe Region (WHO-Euro) has commissioned a three-day basic course on health-care waste management (developed by ETLog Health GmbH). The training is aimed at employees of the middle or higher management level of a health-care institution (hospitals, but also larger clinics and laboratories) who are or will be directly or indirectly responsible for monitoring and managing the safe handling of health-care waste. This includes matrons,

heads of logistic or environmental departments, members of infection-control committees, medical staff from immunization departments, sanitary epidemiological services and others.

The training package consists of a tutorial, a compendium on health-care waste with background information and aid materials (e.g. forms, stickers, posters), and PowerPoint presentations (approximately 25–35 slides per training module). The modules are presented by an experienced health-care waste-management trainer, and include simulations, questions, exercises, and practical demonstrations to make the learning enjoyable and to encourage a high level of knowledge retention.

Table A2.2 shows the schedule for the three-day course.

Table A2.2 Schedule for WHO-Euro's three-day course on health-care waste management

Time	Module	Day 1
08:30–9:00	–	Welcome to participants
09:00–9:30	1	Health-care waste: definition, classification and generation
09:30–10:15	2	Risks of health-care waste for humans
10:15–10:30	Workshop 1	Risk assessment
10:30–11:00		Break
11:00–11:45	3	Waste segregation: the key for waste management
11:45–12:30	Workshop 2	Segregation quiz
12:30–13:30		Lunch
13:30–14:15	4	Transport and storage of health-care waste
14:15–15:00	Workshop 3	Storage facility design
15:00–15:15		Break
15:15–16:00	5	Sharps waste: handling and mitigation measures
16:00–16:45	Workshop 4	Sharps incident
16:45–17:00	–	Wrap-up and evaluation
Time	Module	Day 2
09:00–09:15	–	Review of Day 1
09:15–09:45	6	International regulations, guidelines, policies: health-care waste
09:45–10:30	7	The health-care waste officer (HWO)
10:30–11:00		Break
11:00–11:30	Workshop 5	Convince the manager (HWO/director)
11:30–12:30	8	Onsite treatment of infectious waste
12:30–13:30		Lunch
13:30–14:00	9	Introduction snap shot analysis
14:00–17:00	Workshop 6	Snap shot analysis in a local health-care facility
Time	Module	Day 3
09:00–09:45	–	Wrap-up and evaluation
09:45–10:15	10	Recycling, reduction and eco-efficiency
10:15–10:30	Workshop 7	Recycling of medical waste – example
10:30–11:00		Break
11:00–11:30	11	General chemical waste management
11:30–11:45	Workshop 8	Workshop chemical risk signs
11:45–12:30	12	Waste-management plan: plans, policies and actions plans
12:30–13:30		Lunch
13:30–14:15	Workshop 9	Action plan

Table A2.2 *continued*

Time	Module	Day 1
14:15–15:00	–	Test
15:00–15:15		Break
15:15–16:00		Evaluation of the training – next steps Certificate presentation

For further information, please contact WHO-Euro, EPI, Copenhagen (<http://www.euro.who.int>) or ETLog Health GmbH (info@etlog-health.de).

A2.3 UNDP health-care waste-management training

The United Nations Development Programme’s Global Environment Facility (UNDP GEF) Global Healthcare Waste Project, in cooperation with WHO, Health Care Without Harm and the University of Illinois-Chicago School of Public Health, has developed a set of modules for health-care waste-management training. The modules consist of slide presentations, an instructor’s guide and a set of evaluation tools. Modules can be selected and tailored for specific audiences.

Table A2.3 presents a sample master curriculum for the training modules.

Table A2.3 Content of the UNDP health-care waste-management training modules

Topic	Duration
Module 1: Health and environmental impacts of infectious and other hazardous health-care waste	2.5 hours
Module 2: International and national health-care waste-management legislation and laws	2 hours
Module 3: Health-care waste-management planning and guiding principles	2.5 hours
Module 4: Worker health and safety and contingency planning	2.5 hours
Module 5: Health-care waste-management review walkthrough	4 hours ^a
Module 6a: Specific waste – infectious waste management	2.5 hours
Module 6b: Specific waste – chemical waste management	2 hours
Module 6a: Specific waste – wastewater management	1.5 hours
Module 7a: Health-care waste-management system – classification and segregation	2 hours
Module 7b: Health-care waste-management system – handling and storage	2 hours
Module 7c: Health-care waste-management system – onsite transport	1.5 hours
Module 8: Institutionalizing a health-care waste-management programme – organization, training, budget and quality control	4 hours
Module 9: Models of health-care waste management around the world	1 hour
Mini presentations	2 hours ^b
Evaluation	1 hour
Total	33 hours

Please note: all modules include time for group activity and debriefing.

^a The walkthrough includes time to instruct the group about the activity and debriefing after a two-hour walkthrough survey (does not include travel time)

^b Mini presentations by individual trainees, each lasting about five minutes. This will also be a small-group activity. Duration includes assigning modules to each participant at beginning of training.

A2.3.1 Example module outline

Module 1: Health and environmental impacts of infectious and other hazardous health-care waste

- Duration: 2.5 hours
- Methodology:
 - Lecture/discussion
 - Small-group activity
- Training aids:
 - Projector
 - PowerPoint presentation
 - Flip chart and marker pens and/or board and chalk
- Objectives:
 - Identify the major and minor sources of health-care waste
 - List the key hazards of health-care wastes
 - Characterize the people at risk of exposure to hazardous health-care waste
 - Describe the chain of infection and how to intervene
 - Identify key routes of exposure
 - List common pathogens associated with health-care waste
 - Discuss potential public health and environmental impacts of health-care waste in your country
- Expected outcomes – participants will be able to:
 - Characterize main types of hazards associated with health-care wastes
 - Describe potential health effects of health-care wastes
 - Identify who is at risk of exposure to health-care wastes
 - Describe the public and environmental impacts of health-care wastes
- Trainer/participant activities:
 - The trainer presents the risks associated with health-care waste, the chain of infection, routes of exposure, major sources of disease transmission, and the link between health-care waste management and infection control.
 - Activity: The purpose of this activity is for participants to make a list of possible hazards related to infectious health-care waste within a health-care facility (their own or another). The trainer asks the participants to pair up with their neighbouring course participant and share some strategies for reducing or eliminating exposure to these health-care waste hazards.
 - The trainer and participants discuss the importance of proper health-care waste disposal.
- Resources:
 - Chapters 2 and 3 of *Safe management of waste from health-care activities* (World Health Organization, 2012 – the “Blue Book”)
 - Module 2: International and national health-care waste-management legislation and law.

For further information, please contact: www.gefmedwaste.org.

A3 Chemical destruction methods for cytostatic drugs

Note: The text of Methods 1–11, with minor editorial changes, is taken from the following publications with the permission of the International Agency for Research on Cancer (IARC):

IARC (1983). *Laboratory decontamination and destruction of carcinogens in laboratory wastes: some hydrazines*. IARC Scientific Publications, No. 54. Lyon, International Agency for Research on Cancer.

IARC (1985). *Laboratory decontamination and destruction of carcinogens in laboratory wastes: some antineoplastic agents*. IARC Scientific Publications, No. 73. Lyon, International Agency for Research on Cancer.

Introduction

Use of the methods described in this annex requires precautions in the handling both of cytostatic drugs and of some corrosive chemicals; for example, it is essential to wear gloves for the work.

A number of guidelines for the safe handling of antineoplastic agents have been published elsewhere (Knowles & Virden, 1980; David, 1981; Harrison, 1981; Zimmerman et al., 1981; Anderson et al., 1982; National Institutes of Health, 1982; Jones et al., 1983; Solimando, 1983; Stolar et al., 1983; National Study Commission on Cytotoxic Exposure, 1984; American Society of Hospital Pharmacists, 1985); the following warnings and precautions should also be observed during performance of the tests described here:

- Concentrated sulfuric and hydrochloric acids and sodium hydroxide are corrosive and should be handled with care. All reactions should be carried out in a well-ventilated fume cupboard.
- Care should be taken in the preparation of solutions of potassium permanganate in sulfuric acid: solid potassium permanganate should never be added to concentrated sulfuric acid.
- The dilution of concentrated sulfuric acid with water is an extremely exothermic reaction; the acid should always be added to the water (never the reverse) and the heat of reaction removed by cooling in a cold-water bath.
- Potassium permanganate is a strong oxidizing agent; care must be taken not to mix it with concentrated reducing agents.
- In case of skin contact with corrosive chemicals, the skin should be washed under running water for at least 15 minutes.
- Dry sodium nitrate is highly combustible.

All the methods described in this annex have been tested for efficiency of degradation and absence of mutagenic activity of the residues. If more information is required for testing, details of the methods can be found in IARC Scientific Publications, No. 54 (1983) and No. 73 (1985).

A3.1 Method 1: Destruction of doxorubicin and daunorubicin using potassium permanganate/sulfuric acid

Doxorubicin or daunorubicin, 30 mg, dissolved in 3 mol/litre sulfuric acid, 10 ml, is destroyed by potassium permanganate, 1 g, in 2 hours.

1. Reagents

- Potassium permanganate: technical grade
 - Sulfuric acid (concentrated): relative density 1.84 (about 18 mol/litre), technical grade
 - Sulfuric acid (dilute): 3 mol/litre, aqueous
-

Note: The dilution of concentrated sulfuric acid is an extremely exothermic reaction. Always add the acid to the water, never the reverse, and remove heat by cooling in a cold-water bath

- Potassium permanganate/sulfuric: to 100 ml of 3 mol/litre sulfuric acid, add 4.7 g solid acid solution: potassium permanganate
-

Note 1: To avoid frothing, add the potassium permanganate in small increments.

Note 2: The reagent should always be freshly prepared on the day of use.

- Ascorbic acid or sodium bisulfite, technical grade
- Ascorbic acid solution or 50 g/litre, aqueous sodium bisulfite solution
- Sodium hydroxide, technical grade
- Sodium hydroxide solution 2 mol/litre (8g/100 ml), aqueous
- Sodium carbonate, technical grade

2. Apparatus

- Standard laboratory equipment

3. Procedure (see Fig. A3.1)

3.1 Solid compounds

3.1.1 Estimate the amount of drug to be destroyed, and dissolve in 3 mol/litre sulfuric acid to obtain a maximum content of 3 mg/ml.

3.1.2 Place flask on a magnetic stirrer; add about 1 g potassium permanganate per 10 ml of solution from 3.1.1.

Note: To avoid frothing, add the potassium permanganate in small increments.

3.1.3 Allow to react for 2 hours with stirring.

3.1.4 Neutralize with 8 g/100 ml sodium hydroxide solution, and discard.

3.2 Aqueous solutions

3.2.1 Estimate the amount of drug to be destroyed, and dilute with water if necessary to obtain a maximum concentration of 3 mg/ml.

3.2.2 Add slowly, with stirring, enough concentrated sulfuric acid to obtain a 3 mol/litre solution, and allow to cool to room temperature.

3.2.3 Proceed as in 3.1.2 to 3.1.4.

3.3 Pharmaceutical preparations

Note: To avoid frothing, add potassium permanganate in small increments.

3.3.1 Liquids: proceed as in 3.2, using twice the amount of potassium permanganate.

3.3.2 Solids: dissolve in water and proceed as in 3.2, using twice the amount of potassium permanganate.

3.4 Glassware

3.4.1 Immerse in a freshly prepared solution of potassium permanganate/sulfuric acid. Allow to react for 2 hours.

3.4.2 Clean the glass by immersion in a solution of ascorbic acid or sodium bisulfite.

3.5 Spills of solid compounds

3.5.1 Isolate the area, and put on suitable protective clothing.

3.5.2 Pour an excess of potassium permanganate/sulfuric acid solution over the contaminated area. If the purple colour fades, add more potassium permanganate. Allow to react for 2 hours.

3.5.3 Decolorize the surface with a solution of ascorbic acid or sodium bisulfite.

3.5.4 Neutralize by addition of solid sodium carbonate.

3.5.5 Remove the decontamination mixture with an absorbent material.

3.5.6 Discard.

3.6 Spills of aqueous solutions or of pharmaceutical preparations.

Proceed as in 3.5.

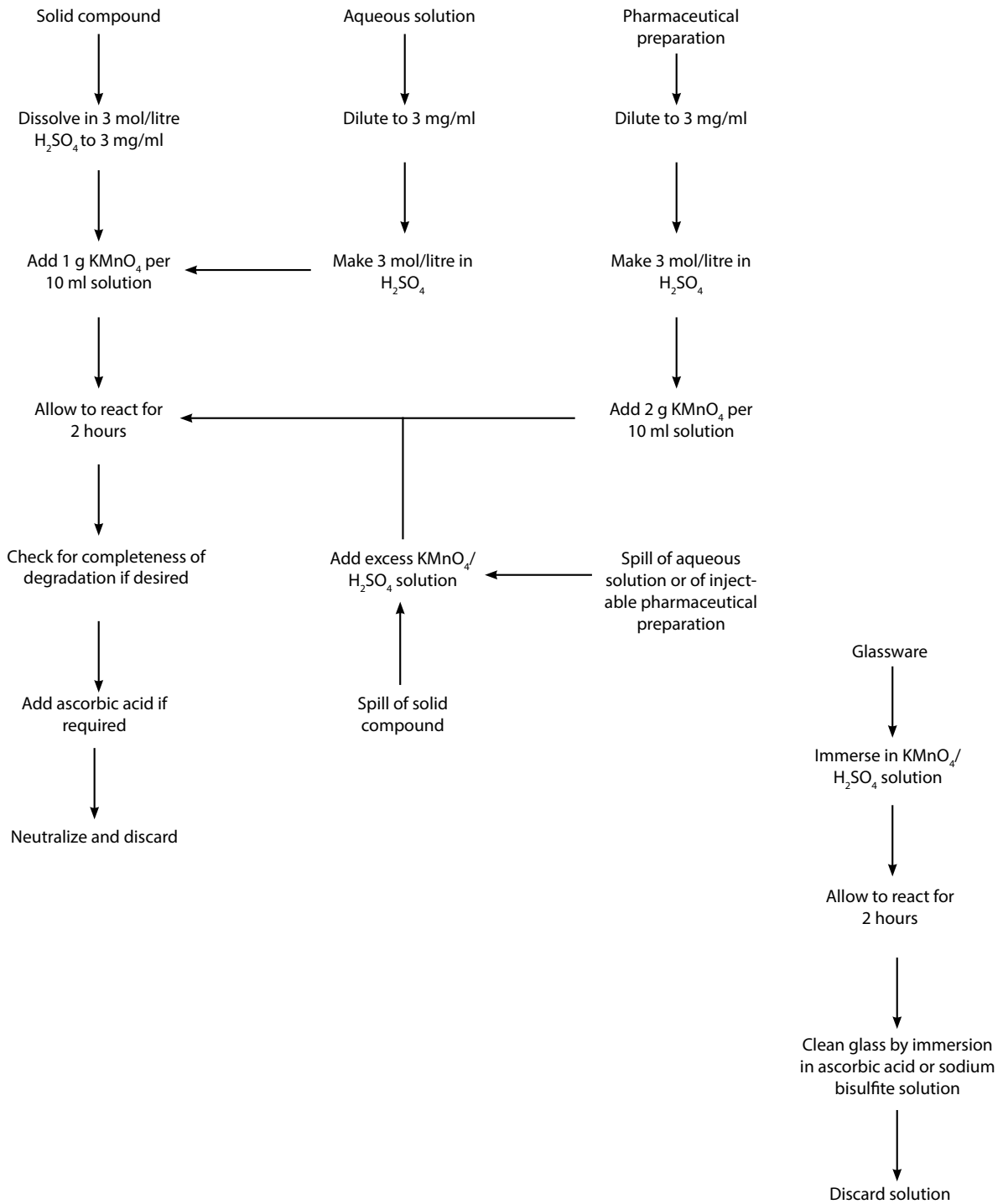

Figure A3.1 Schematic representation of procedure for destruction of doxorubicin or daunorubicin

A3.2 Method 2: Destruction of methotrexate and dichloromethotrexate using potassium permanganate/sulfuric acid

Methotrexate, 50 mg, or dichloromethotrexate, 10 mg, solid compound, dissolved in 3 mol/litre sulfuric acid, 10 ml, is destroyed by potassium permanganate, 0.5 g, in 1 hour.

Note: In the case of pharmaceutical preparations of dichloromethotrexate, up to 50 mg can be dissolved in 10 ml of 3 mol/litre sulfuric acid and can be satisfactorily destroyed with 0.5 g of potassium permanganate.

1. Reagents

- Potassium permanganate: technical grade
 - Sulfuric acid (concentrated): relative density 1.84 (about 18 mol/litre); technical grade sulfuric acid (dilute): 3 mol/litre, aqueous
-

Note: The dilution of concentrated sulfuric acid is an extremely exothermic reaction. Always add the acid to the water, never the reverse, and remove heat by cooling in a cold-water bath.

- Potassium permanganate/sulfuric: to 100 ml of 3 mol/litre sulfuric acid, add 4.7 g solid acid solution: potassium permanganate
-

Note 1: To avoid frothing, add the potassium permanganate in small increments.

Note 2: The reagent should always be freshly prepared on the day of use.

- Ascorbic acid or sodium bisulfite, technical grade
- Ascorbic acid solution or 50 g/litre aqueous sodium bisulfite solution
- Sodium hydroxide, technical grade
- Sodium hydroxide solution: 2 mol/litre (8 g/100 ml), aqueous

2. Apparatus

- Standard laboratory equipment

3. Procedure (see Fig. A3.2)

3.1 Solid compounds

3.1.1 For each 50 mg methotrexate or about 10 mg dichloromethotrexate, add 10 ml of 3 mol/litre sulfuric acid.

3.1.2 Place on a magnetic stirrer, and add 0.5 g potassium permanganate per 10 ml of solution.

Note: To avoid frothing, add the potassium permanganate in small increments.

3.1.3 Continue stirring for 1 hour.

3.1.4 Neutralize with 8 g/100 ml sodium hydroxide solution and discard.

3.2 Aqueous solutions

3.2.1 Dilute with water to obtain a maximum concentration of 5 mg/ml methotrexate or 1 mg/ml dichloromethotrexate.

3.2.2 Add slowly, with stirring, enough concentrated sulfuric acid to obtain a 3 mol/litre solution.

3.2.3 Proceed as in 3.1.2 to 3.1.4.

3.3 Injectable pharmaceutical preparations

Note: This method has been tested using solutions containing 2–5% glucose and 0.45% saline.

3.3.1 Dilute with water to obtain a maximum concentration of 2.5 mg/ml of either compound.

3.3.2 Add slowly, with stirring, enough concentrated sulfuric acid to obtain a 3 mol/litre solution.

3.3.3 Add 1 g potassium permanganate for each 10 ml solution and continue stirring for 1 hour.

Note: To avoid frothing, add potassium permanganate in small increments.

3.4.4 Proceed as in 3.1.4.

3.4 Glassware

3.4.1 Immerse in a freshly prepared solution of potassium permanganate/sulfuric acid. Allow to react for 1 hour or more.

3.4.2 Clean the glass by immersion in a solution of ascorbic acid or sodium bisulfite.

3.5 Spills of solid compounds

3.5.1 Isolate the area, and put on suitable protective clothing.

3.5.2 Collect the solid, place it in a beaker and treat as in 3.1.

3.5.3 Rinse the area with an excess of 3 mol/litre sulfuric acid. Take up the rinse with absorbent material.

3.5.4 Place the absorbent material in a beaker and cover with potassium permanganate/sulfuric acid solution. Allow to react for 1 hour or more. If the purple colour fades, add more potassium permanganate.

3.5.5 Neutralize by addition of solid sodium carbonate. Discard.

3.6 Spills of aqueous solutions or of injectable pharmaceutical preparations

3.6.1 Isolate the area, and put on suitable protective clothing.

3.6.2 Take up the spill with absorbent material. Place the material in a beaker for inactivation.

3.6.3 Rinse the area with 3 mol/litre sulfuric acid and take up the rinse with absorbent material. Place the material in the same beaker as the other waste.

3.6.4 Proceed as in 3.5.4 and 3.5.5.

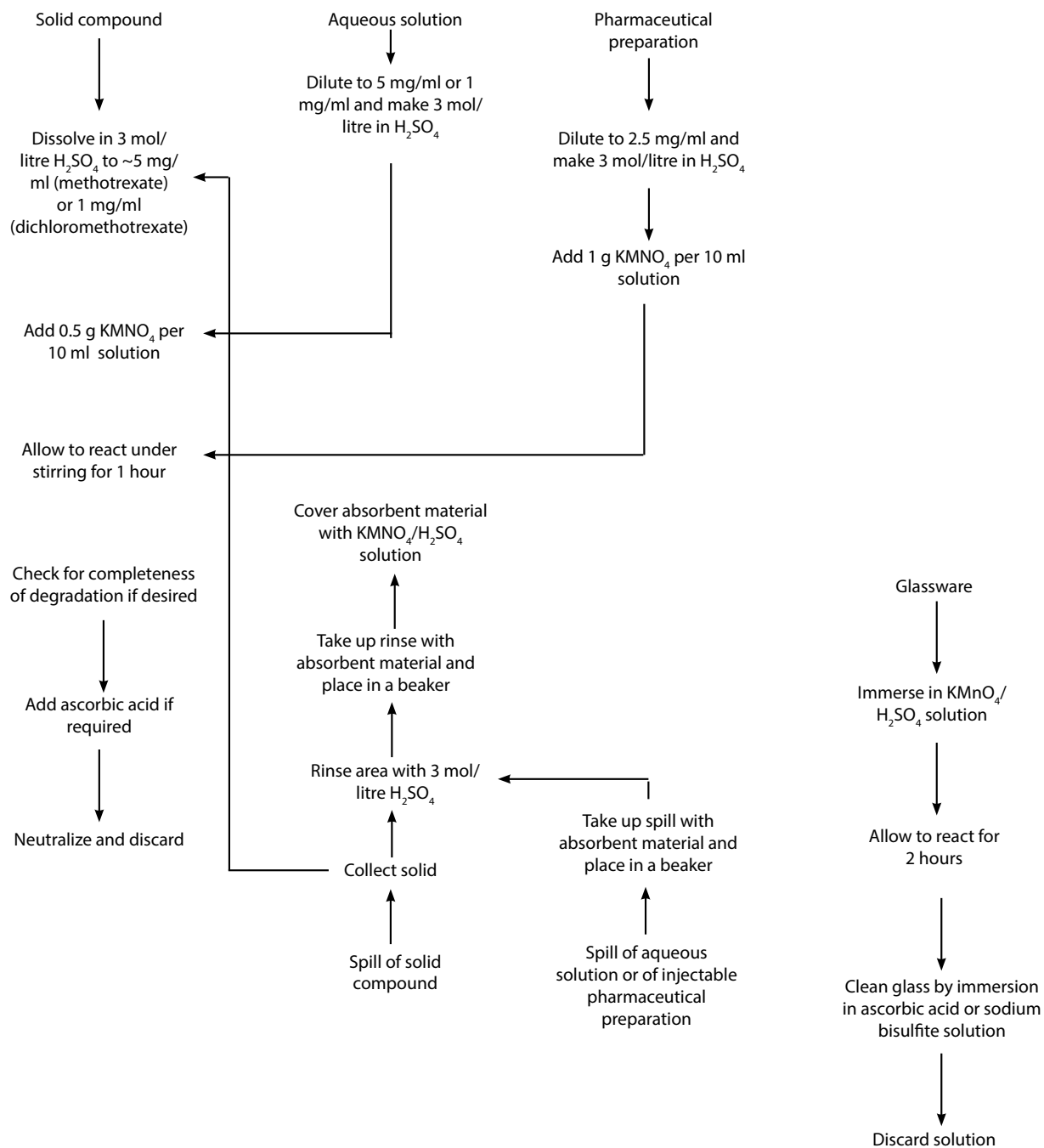

Figure A3.2 Schematic representation of procedure for destruction of methotrexate or dichloromethotrexate using potassium permanganate/sulfuric acid

A3.3 Method 3: Destruction of methotrexate using aqueous alkaline potassium permanganate

Methotrexate, 50 mg, dissolved in 4 g/100 ml sodium hydroxide solution, 50 ml, is destroyed by 1 g/100 ml potassium permanganate solution, 5.5 ml, in 30 minutes.

1. Reagents

- Potassium permanganate: technical grade
- Sodium hydroxide: technical grade
- Sodium bisulfite: technical grade
- Potassium permanganate solution: 0.06 mol/litre (1 g/100 ml), aqueous
- Sodium bisulfite solution: 0.1 mol/litre (1 g/100 ml), aqueous
- Sodium hydroxide solution: 1 mol/litre (4 g/100 ml), aqueous
- Aqueous sodium hydroxide/potassium permanganate solution: 2 mol/litre (8 g/100 ml)

2. Apparatus

- Standard laboratory equipment

3. Procedure (see Fig. A3.3)

3.1 Solid compound: 1 g/100 ml potassium permanganate in 4 g/100 ml sodium hydroxide

3.1.1 Dissolve in 4 g/100 ml sodium hydroxide solution to obtain a concentration of not more than 1 mg/ml.

3.1.2 Add potassium permanganate solution until the purple colour persists for 30 minutes.

3.1.3 Add sodium bisulfite solution to the reaction mixture until the purple colour disappears.

3.1.4 Discard.

3.2 Aqueous solutions, including injectable pharmaceutical preparations

3.2.1 Add an equal volume of 8 g/100 ml sodium hydroxide solution.

3.2.2 Proceed as in 3.1.2 to 3.1.4.

3.3 Glassware

3.3.1 Immerse in potassium permanganate/sodium hydroxide solution. Allow to react for 30 minutes.

3.3.2 Clean the glass by immersion in sodium bisulfite solution.

3.4 Spills of solid compound

3.4.1 Isolate the area, and put on suitable protective clothing.

3.4.2 Collect the solid and place it in a beaker.

3.4.3 Rinse the area with 4 g/100 ml sodium hydroxide solution.

3.4.4 Take up the rinse with absorbent material. Place the material in the same beaker as the solid.

3.4.5 Cover the waste in the beaker with potassium permanganate/sodium hydroxide solution and allow to react for 30 minutes.

3.4.6 Discard.

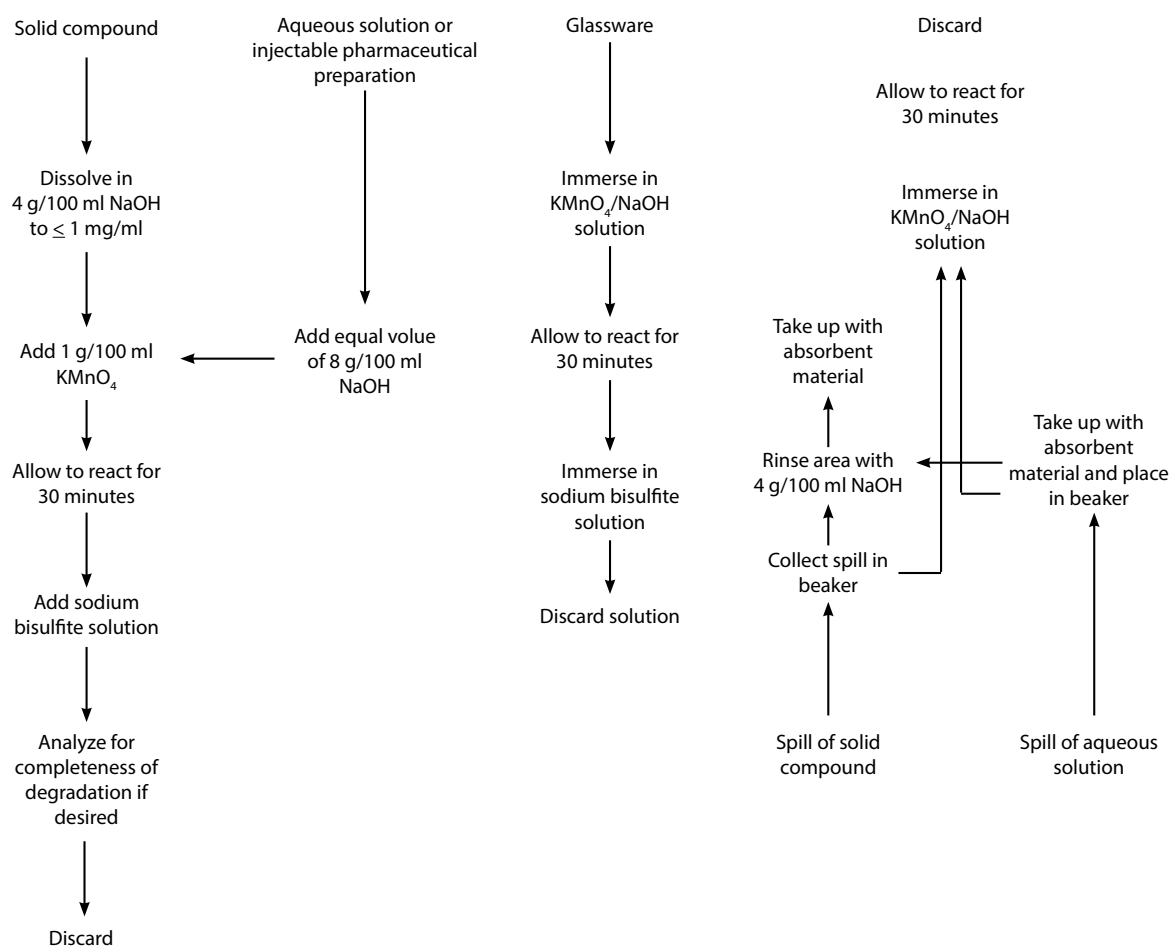

Figure A3.3 Schematic representation of procedure for destruction of methotrexate using aqueous alkaline potassium permanganate

3.5 Spill of aqueous solutions

3.5.1 Isolate the area, and put on suitable protective clothing.

3.5.2 Take up the spill with absorbent material. Place the material in a beaker and cover with potassium permanganate/sodium hydroxide solution.

3.5.3 Proceed as in 3.4.3 to 3.4.6.

A3.4 Method 4: Destruction of methotrexate using aqueous sodium hypochlorite

Methotrexate, 50 mg, dissolved in 4 g/100 ml sodium hydroxide solution, 100 ml, is destroyed by 5% sodium hypochlorite solution, 4.6 ml, in 30 minutes.

1. Reagents

- Sodium hypochlorite solution: commercial grade, 5%
- Sodium hydroxide: technical grade
- Sodium hydroxide solution: 1 mol/litre (4 g/100 ml), aqueous

2. Apparatus

- Standard laboratory equipment

3. Procedure (see Fig. A3.4)

Note 1: Solutions of sodium hypochlorite tend to deteriorate, and it is therefore essential to check their active chlorine content. The strength of sodium hypochlorite solutions may be given as weight/weight or weight/volume, which is an additional reason for estimating the concentration of available chlorine.

Note 2: Percentage (%) available chlorine = mass of chlorine in grams liberated by acidifying 100 g of sodium hypochlorite solution.

Note 3: The sodium hypochlorite solution used for this determination should contain not less than 25 g and not more than 30 g of active chlorine per litre. Assay: pipette 10.00 ml sodium hypochlorite solution into a 100-ml volumetric flask and fill to the mark with distilled water. Pipette 10 ml of the resulting solution into a conical flask containing 50 ml distilled water, 1 g potassium iodide, and 12.5 ml acetic acid (2 mol/litre). Rinse and titrate with 0.1 mol/litre sodium thiosulfate solution, using starch as indicator; 1 ml of 0.1 mol/litre sodium thiosulfate solution corresponds to 3.545 mg active chlorine.

3.1 Solid compound

3.1.1 Dissolve in 4 g/100 ml sodium hydroxide solution to obtain a concentration of not more than 50 mg/100 ml.

3.1.2 Estimate the amount of sodium hypochlorite solution required.

3.1.3 Add at least twice this estimated amount, i.e. approx. 10 ml sodium hypochlorite solution for each 50 mg of methotrexate. Allow to react for 30 minutes.

3.1.4 Discard.

3.2 Aqueous solutions, including injectable pharmaceutical preparations

3.2.1 Estimate the amount of methotrexate to be degraded.

3.2.2 Proceed as in 3.1.2 to 3.1.4.

3.3 Glassware

3.3.1 Immerse in sodium hypochlorite solution. Allow to react for 30 minutes.

3.3.2 Discard the solution.

A3.5 Method 5: Destruction of cyclophosphamide and ifosfamide using alkaline hydrolysis in the presence of dimethylformamide

Cyclophosphamide or ifosfamide, 100 mg, in dimethylformamide, 20 ml, is destroyed by 12 g/100 ml sodium hydroxide solution, 10 ml, when refluxed for 4 hours.

1. Reagents

- Sodium hydroxide: technical grade
- Sodium hydroxide solution: ~10 mol/litre (40 g/100 ml), aqueous ~3 mol/litre (12 g/100 ml)
- Dimethylformamide (DMF), analytical grade
- DMF/sodium hydroxide solution: freshly prepared solution containing 2 volumes of DMF and 1 volume of 12 g/100 ml sodium hydroxide

2. Apparatus

- Standard laboratory equipment

3. Procedure (see Fig. A3.5)

3.1 Solid compounds

3.1.1 For each 100 mg of sample, add 30 ml DMF/sodium hydroxide solution.

3.1.2 Reflux for 4 hours.

3.1.3 Dilute with water and discard.

3.2 Aqueous solutions and pharmaceutical solutions

3.2.1 Dilute with 40 g/100 ml sodium hydroxide solution to obtain a maximum cyclophosphamide and/or ifosfamide content of 10 g/litre and a minimum sodium hydroxide concentration of 12 g/100 ml.

3.2.2 Add 2 ml DMF for each ml of solution from 3.2.1.

3.2.3 Proceed as in 3.1.2 to 3.1.3.

3.3. Glassware

3.3.1 Rinse with two successive portions of 12 g/100 ml sodium hydroxide, then two successive portions of water (enough to wet all the glass). Drain completely between each rinse.

3.3.2 Treat rinses as in 3.2.

3.4 Spills of solid compounds

3.4.1 Isolate the area, and put on suitable protective clothing.

3.4.2 Collect the solid, place it in a beaker and treat as in 3.1.

3.4.3 Rinse the area twice with an excess of 12 g/100 ml sodium hydroxide solution.

3.4.4 Take up the rinse with absorbent material, and immerse the material in a freshly prepared DMF/sodium

hydroxide solution.

3.4.5 Repeat steps 3.4.3 and 3.4.4.

3.4.6 Reflux for 4 hours.

3.5 Spills of aqueous solutions

3.5.1 Isolate the area, and put on suitable protective clothing.

3.5.2 Take up the spill with absorbent material, and immerse the material in a freshly prepared DMF/sodium hydroxide solution.

3.5.3 Proceed as in 3.4.3 to 3.4.6.

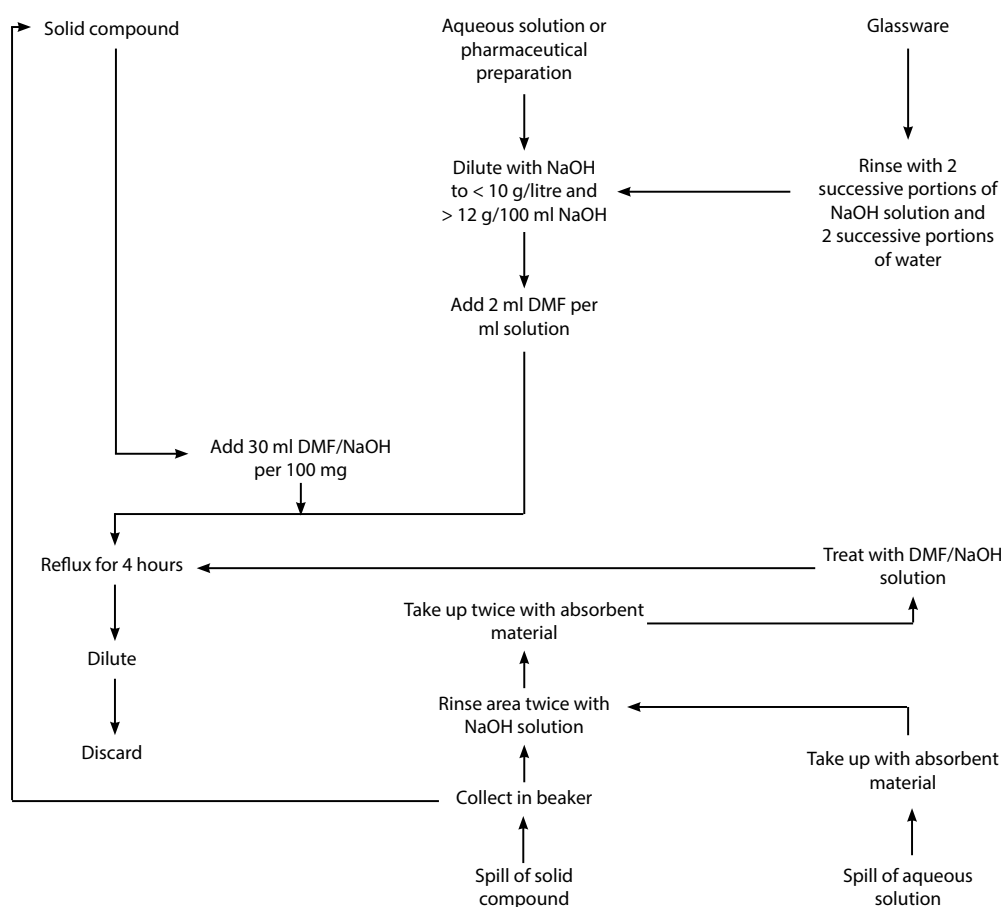

Figure A3.5 Schematic representation of procedure for destruction of cyclophosphamide and ifosfamide using alkaline hydrolysis in the presence of dimethylformamide

A3.6 Method 6: Destruction of cyclophosphamide using acid hydrolysis followed by addition of sodium thiosulfate and alkaline hydrolysis

A sample of 250 mg cyclophosphamide dissolved in 10 ml of 1 mol/litre hydrochloric acid is completely hydrolysed when refluxed for 1 hour. After addition of 1.5 g sodium thiosulfate to the neutralized reaction mixture, the medium is made strongly alkaline with 20 g/100 ml sodium hydroxide solution and the reaction is allowed to proceed for 1 hour.

1. Reagents

- Sodium hydroxide: technical grade
- Sodium hydroxide solution: 5 mol/litre (20 g/100 ml), aqueous
- Sodium thiosulfate: technical grade
- Hydrochloric acid relative density 1.19 (~12 mol/litre) (concentrated), technical grade
- Hydrochloric acid (dilute): 1 and 2 mol/litre, aqueous
- pH paper

2. Apparatus

- Standard laboratory equipment

3. Procedure (see Fig. A3.6)

3.1 Solid compound

3.1.1 For each 250 mg of sample, add 10 ml of 1 mol/litre hydrochloric acid.

3.1.2 Reflux for 1 hour. Allow to cool to room temperature.

3.1.3 Add 20 g/100 ml sodium hydroxide solution until a pH of about 6 is obtained. Allow to cool to room temperature.

3.1.4 Add 1.5 g sodium thiosulfate for each 250 mg cyclophosphamide and make strongly alkaline with 20 g/100 ml sodium hydroxide solution.

3.1.5 Allow to react for 1 hour.

3.1.6 Dilute with water and discard.

3.2 Aqueous solutions and injectable pharmaceutical preparations

3.2.1 Dilute if necessary to obtain a maximum cyclophosphamide content of 25 g/litre and add concentrated hydrochloric acid to obtain a 1 mol/litre hydrochloric acid solution.

3.2.2 Proceed as in 3.1.2 to 3.1.6.

3.3 Glassware

3.3.1 Rinse with four successive portions of 1 mol/litre hydrochloric acid solution (enough to wet all the glass). Drain completely between each rinse.

3.3.2 Treat rinses as in 3.1.2 to 3.1.6.

3.4 Spills of solid compound

3.4.1 Isolate the area, and put on suitable protective clothing.

3.4.2 Collect the solid and place in a beaker.

3.4.3 Rinse the area with four successive portions of enough 1 mol/litre hydrochloric acid to wet it. Take up each rinse with absorbent material. Place the material in the beaker containing the solid from 3.4.2.

3.4.4 Cover the contents of the beaker from 3.4.2 and 3.4.3 with 1 mol/litre hydrochloric acid solution.

3.4.5 Proceed as in 3.1.2 to 3.1.5.

3.4.6 Discard.

3.5 Spills of aqueous solutions

3.5.1 Isolate the area, and put on suitable protective clothing.

3.5.2 Take up the spill with absorbent material. Place the material in a beaker and cover with 1 mol/litre hydrochloric acid.

3.5.3 Rinse the area with four successive portions of enough 1 mol/litre hydrochloric acid to wet it.

3.5.4 Take up each rinse with absorbent material, and immediately immerse the material in the beaker containing the residues from 3.5.2.

3.5.5 Proceed as in 3.1.2 to 3.1.6.

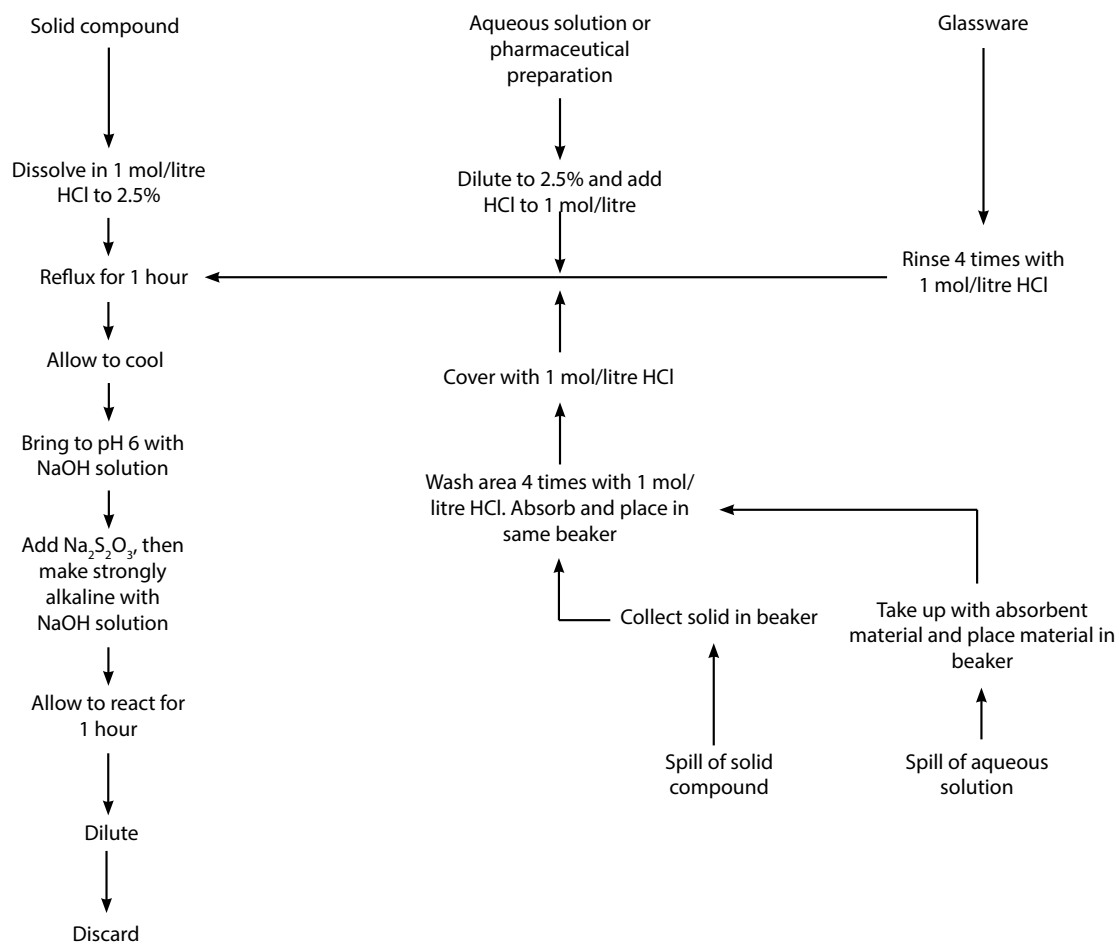

Figure A3.6 Schematic representation of procedure for destruction of cyclophosphamide using acid hydrolysis followed by addition of sodium thiosulfate and aqueous hydrolysis

A3.7 Method 7: Destruction of vincristine sulfate and vinblastine sulfate using potassium permanganate/sulfuric acid

Vincristine sulfate or vinblastine sulfate, 10 mg, in 10 ml of 3 mol/litre sulfuric acid, is completely destroyed by 0.5 g of potassium permanganate in 2 hours.

1. Reagents

- Potassium permanganate: technical grade
- Sulfuric acid (concentrated): relative density 1.84 (18 mol/litre), technical grade
- Sulfuric acid (dilute): 3 mol/litre, aqueous

Note: The dilution of concentrated sulfuric acid is an extremely exothermic reaction. Always add the acid to the water, never the reverse, and remove heat by cooling in a cold-water bath.

- Potassium permanganate to 100 ml of 3 mol/litre sulfuric acid
 - Sulfuric acid solution, add 4.7 g solid potassium permanganate
-

Note 1: To avoid frothing, add the potassium permanganate in small increments.

Note 2: The reagent should always be freshly prepared on the day of use.

- Ascorbic acid or sodium bisulfite, technical grade
- Ascorbic acid solution or sodium bisulfite: 50 g/litre, aqueous solution
- Sodium hydroxide, technical grade
- Sodium hydroxide solution: 2 mol/litre (8 g/100 ml), aqueous
- Sodium carbonate, technical grade

2. Apparatus

- Standard laboratory equipment

3. Procedure (see Fig. A3.7)

3.1 Solid compounds

3.1.1 Estimate the amount of drug to be destroyed, and dissolve in 3 mol/litre sulfuric acid to obtain a maximum content of 1 mg/ml.

3.1.2 Place flask on a magnetic stirrer; add 0.5 g potassium permanganate per 10 ml of solution from 3.1.1.

3.1.3 Allow to react for 2 hours or more, with stirring.

3.1.4 Neutralize with 8 g/100 ml sodium hydroxide solution and discard.

3.2 Aqueous solutions

3.2.1 Estimate the amount of drug to be destroyed, and dilute with water, if necessary, to a maximum content of 1 mg/ml.

3.2.2 Add slowly, with stirring, enough concentrated sulfuric acid to obtain a 3 mol/litre solution, and allow to cool to room temperature.

3.2.3 Proceed as in 3.1.2 to 3.1.4.

3.3 Pharmaceutical preparations

Note: This method has been tested using the following preparation: 1 mg of compound + 1.275 mg methyl p-hydroxybenzoate + 1.225 mg propyl p-hydroxybenzoate + 100 mg mannitol.

3.3.1 Estimate the amount of drug to be destroyed, and dissolve in 3 mol/litre sulfuric acid to obtain a maximum content of 0.1 mg/ml.

3.3.2 Place on a magnetic stirrer; gradually add 0.5 g potassium permanganate per 10 ml of solution.

Note: To avoid frothing, add the potassium permanganate in small increments.

3.3.3 Proceed as in 3.1.3 to 3.1.4.

3.4 Glassware

3.4.1 Immerse in a freshly prepared solution of potassium permanganate/sulfuric acid. Allow to react for 2 hours or more.

3.4.2 Clean the glass by immersion in a solution of ascorbic acid or sodium bisulfite.

3.5 Spills of solid compounds

3.5.1 Isolate the area, and put on suitable protective clothing.

3.5.2 Collect the solid compound and place it in a beaker.

3.5.3 Rinse the area with water. Take up the rinse with absorbent material, and place the material in the beaker from 3.5.2.

3.5.4 Cover the contents of the beaker from 3.5.3 with potassium permanganate/sulfuric acid solution. Allow to react for 2 hours. If the purple colour fades, add more potassium permanganate.

3.5.5 Discard.

3.6 Spills of aqueous solutions or solutions of pharmaceutical preparations

3.6.1 Isolate the area, and put on suitable protective clothing.

3.6.2 Take up the spill with absorbent material and place the material in a beaker. Rinse the area with water. Take up rinse with absorbent material, and place the material in the same beaker.

3.6.3 Proceed as in 3.5.4 to 3.5.5.

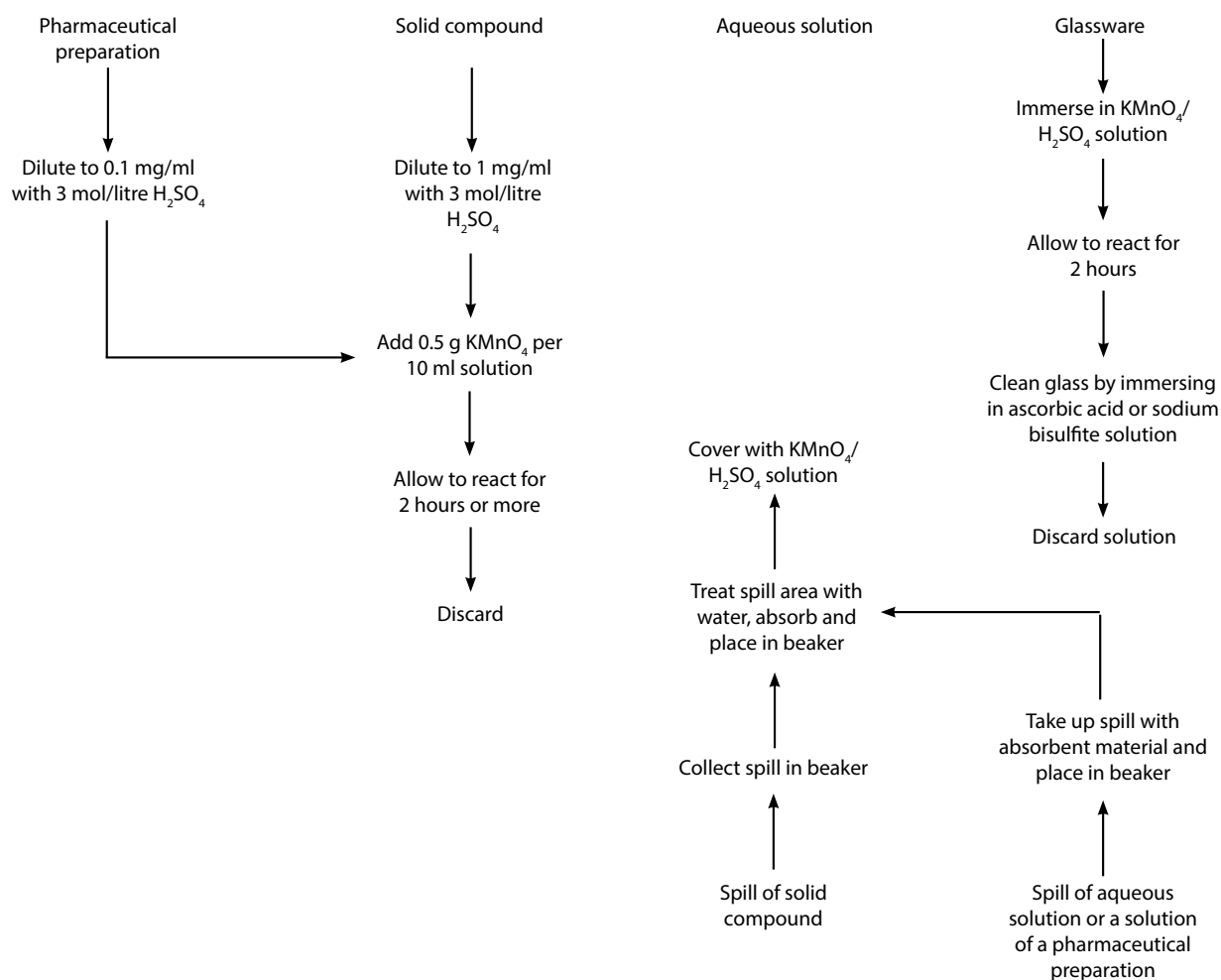

Figure A3.7 Schematic representation of procedure for destruction of vincristine sulfate and vinblastine sulfate

A3.8 Method 8: Destruction of 6-tioguanine and 6-mercaptopurine using potassium permanganate/sulfuric acid

6-tioguanine or 6-mercaptopurine, 18 mg, dissolved in 20 ml of 3 mol/litre sulfuric acid, is destroyed by 0.13 g potassium permanganate in 10–12 hours.

1. Reagents

- Potassium permanganate: technical grade
 - Sulfuric acid (concentrated): relative density 1.84 (about 18 mol/litre); technical grade sulfuric acid (dilute): 3 mol/litre, aqueous

Note: The dilution of concentrated sulfuric acid is an extremely exothermic reaction. Always add the acid to the water, never the reverse, and remove heat by cooling in a cold-water bath.

- Potassium permanganate/sulfuric: to 100 ml of 3 mol/litre sulfuric acid, add 4.7 g solid acid solution: potassium permanganate
-

Note 1: To avoid frothing, add the potassium permanganate in small increments.

Note 2: The reagent should always be freshly prepared on the day of use.

- Ascorbic acid or sodium bisulfite, technical grade
- Ascorbic acid solution or sodium bisulfite solution: 50 g/litre, aqueous
- Sodium hydroxide, technical grade
- Sodium hydroxide solution: 2 mol/litre (8 g/100 ml), aqueous
- Sodium carbonate, technical grade

2. Apparatus

- Standard laboratory equipment

3. Procedure (see Fig. A3.8)

3.1 Solid compound

3.1.1 Estimate the amount of drug to be destroyed and dissolve in 3 mol/litre sulfuric acid to obtain a maximum concentration of 900 mg/litre.

3.1.2 Place flask on a magnetic stirrer; add 0.5 g potassium permanganate per 80 ml of solution from 3.1.1.

3.1.3 Allow to react overnight.

3.1.4 Neutralize with 8 g/100 ml sodium hydroxide solution and discard.

3.2 Aqueous solutions

3.2.1 Estimate the amount of drug to be destroyed and dilute with water if necessary to obtain a maximum concentration of 900 mg/litre.

3.2.2 Add slowly, with stirring, enough concentrated sulfuric acid to obtain a 3 mol/litre solution, and allow to cool to room temperature.

3.2.3 Proceed as in 3.1.2 to 3.1.4.

3.3 Oral preparations

3.3.1 Dissolve in 3 mol/litre sulfuric acid to a maximum concentration of 900 mg/litre.

3.3.2 Place flask on a magnetic stirrer; gradually add 4 g of potassium permanganate per 80 ml of solution.

Note: To avoid frothing, add the potassium permanganate in small increments.

3.3.3 Proceed as in 3.1.3 and 3.1.4.

3.4 Parenteral solutions

Note: This method has been tested using the following two preparations: 7.5 mg 6- tioguanine in 50 ml of 5% dextrose solution, and 10 mg 6-mercaptopurine in 10 ml of 5% dextrose solution.

3.4.1 Add slowly with stirring, enough sulfuric acid to obtain a 3 mol/litre solution, and allow to cool to room temperature.

3.4.2 Proceed as in 3.3.2 and 3.3.3.

3.5 Glassware

3.5.1 Immerse in a freshly prepared solution of potassium permanganate/sulfuric acid. Allow to react for 10–12 hours.

3.5.2 Clean the glass by immersion in a solution of ascorbic acid or sodium bisulfite.

3.6 Spills

3.6.1 Isolate the area, and put on suitable protective clothing.

3.6.2 Collect the solid, or take up the liquid with absorbent material, and place the material in a beaker.

3.6.3 Rinse the area with 0.1 mol/litre sulfuric acid. Take up the rinse with absorbent material, and place the material in the beaker from 3.6.2.

3.6.4 Cover the contents of the beaker from 3.6.3 with 3 mol/litre sulfuric acid and add, with stirring, an excess of potassium permanganate. Allow to react overnight.

Note: At the end of this period, some purple colour should remain; if not, add more potassium permanganate and continue to react.

3.6.5 Discard.

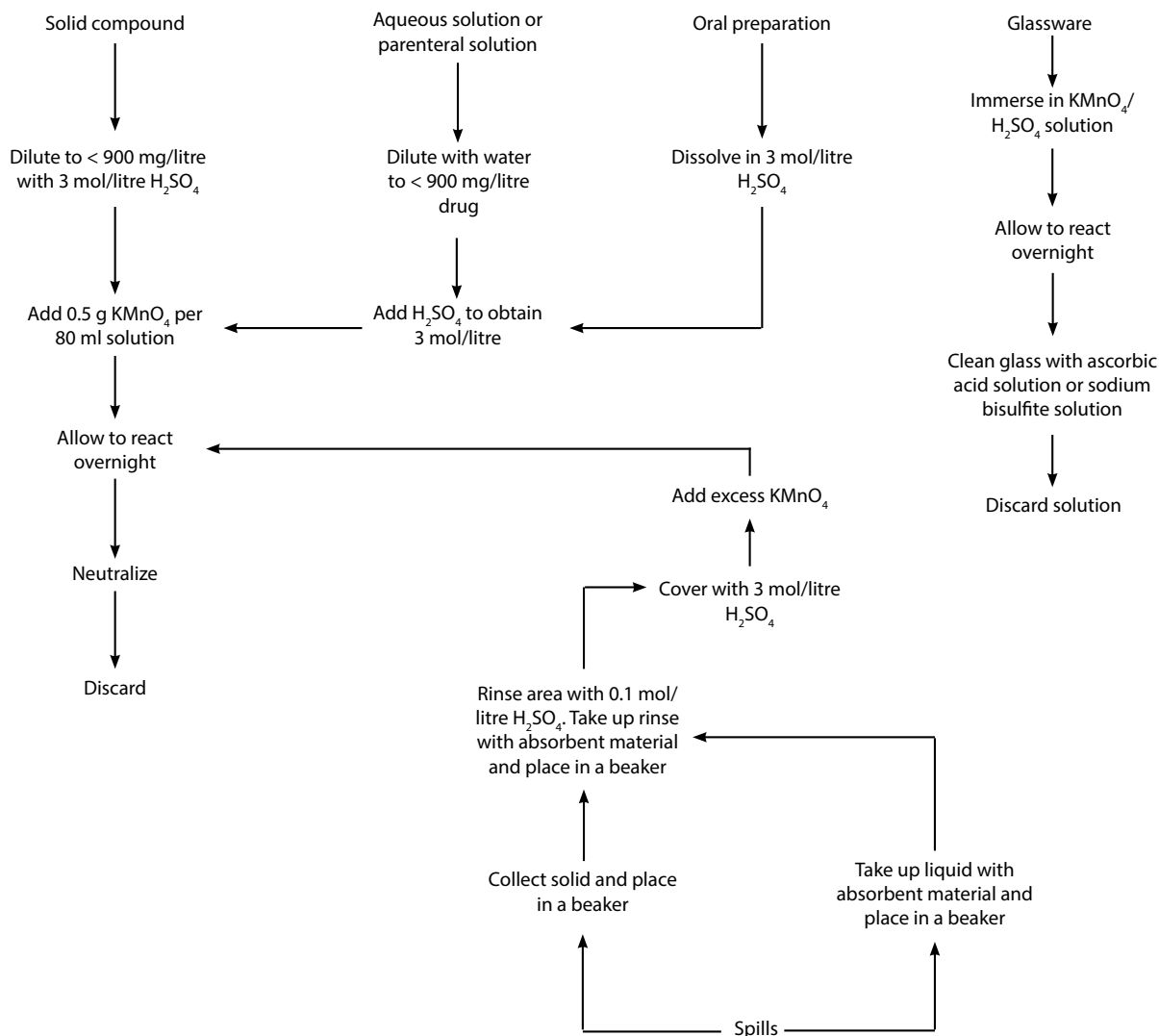

Figure A3.8 Schematic representation of procedure for destruction of 6-thioguanine and 6-mercaptopurine

A3.9 Method 9: Destruction of cisplatin by reduction with zinc powder

Cisplatin, 30 mg, dissolved in 2 mol/litre sulfuric acid, 50 ml, is destroyed by zinc powder, 1.5 g, in 10–12 hours.

1. Reagents

- Sulfuric acid (concentrated): relative density 1.84 (about 18 mol/litre); technical grade sulfuric acid (dilute): ~2 mol/litre and ~4 mol/litre, aqueous

Note: The dilution of concentrated sulfuric acid is an extremely exothermic reaction. Always add the acid to the water, never the reverse, and remove heat by cooling in a cold-water bath.

- Zinc powder: technical grade
- Sodium hydroxide: technical grade
- Sodium hydroxide solution: ~2 mol/litre (~8 g/100 ml), aqueous

2. Apparatus

- Standard laboratory equipment plus sintered glass funnel (porosity 4 or similar).

3. Procedure (see Fig. A3.9)

3.1 Solid compound

3.1.1 Dissolve in 2 mol/litre sulfuric acid solution to achieve a maximum concentration of 0.6 mg/ml.

3.1.2 Place flask on a magnetic stirrer; add 3g zinc powder per 100 ml of solution from 3.1.1.

3.1.3 Stir overnight.

3.1.4 Neutralize with 8 g/100 ml sodium hydroxide solution.

3.1.5 Discard.

3.2 Aqueous solutions and injectable pharmaceutical preparations

Note: This method has been tested using solutions in 5% dextrose or 0.9% saline.

3.2.1 Dilute with water to obtain a maximum concentration of 0.6 mg/ml.

3.2.2 Add slowly, with stirring, enough concentrated sulfuric acid to obtain a 2 mol/litre solution, and allow to cool to room temperature.

3.2.3 Proceed as in 3.1.2 to 3.1.5.

3.3 Glassware

3.3.1 Rinse at least four times with enough water to completely wet the glass.

3.3.2 Treat rinses as in 3.2.

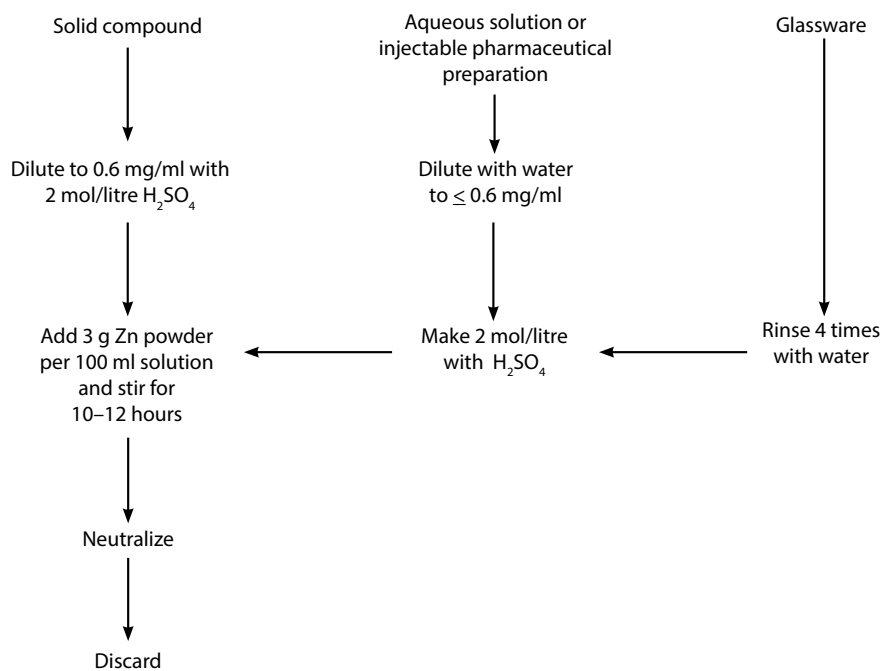

Figure A3.9 Schematic representation of procedure for destruction of cisplatin by reduction with zinc powder

A3.10 Method 10: Destruction of cisplatin by reaction with sodium diethyldithiocarbamate

Cisplatin is destroyed by decomposition with sodium diethyldithiocarbamate.

1. Reagents

- Sodium diethyldithiocarbamate, technical grade
- Sodium hydroxide, technical grade
- Sodium hydroxide solution: 0.1 mol/litre (0.4 g/100 ml), aqueous
- Sodium nitrate, technical grade
- Sodium nitrate solution: saturated, aqueous
- Sodium diethyldithiocarbamate: 0.68 mol/litre (~1 g/100 ml) in 0.1 mol/litre sodium hydroxide solution

2. Apparatus

- Standard laboratory equipment

3. Procedure (see Fig. A3.10)

3.1 Solid compound

3.1.1 Estimate the amount of drug to be destroyed.

3.1.2 Dissolve in water.

3.1.3 For every 100 mg cisplatin, add 3 ml sodium diethyldithiocarbamate solution.

3.1.4 Add an equal volume of sodium nitrate solution.

Note: A yellow precipitate of the complex of platinum II and diethyldithiocarbamate will form when the platinum concentration is greater than 100 mg/ml.

3.1.5 Discard.

3.2 Aqueous solutions, including injectable pharmaceutical preparations

Proceed as in 3.1.

3.3 Glassware

Immerse in a 1:1 mixture of sodium diethyldithiocarbamate solution and sodium nitrate solution.

3.4 Spills

3.4.1 Isolate the area, and put on suitable protective clothing.

3.4.2 Collect solid, or take up liquid with absorbent material, and place in a beaker.

3.4.3 Rinse the area with water and take up the rinse with absorbent material. Place the material in the beaker from 3.4.2.

3.4.4 Cover the contents of the beaker from 3.4.3 with a 1:1 mixture of sodium diethyldithiocarbamate solution and sodium nitrate solution.

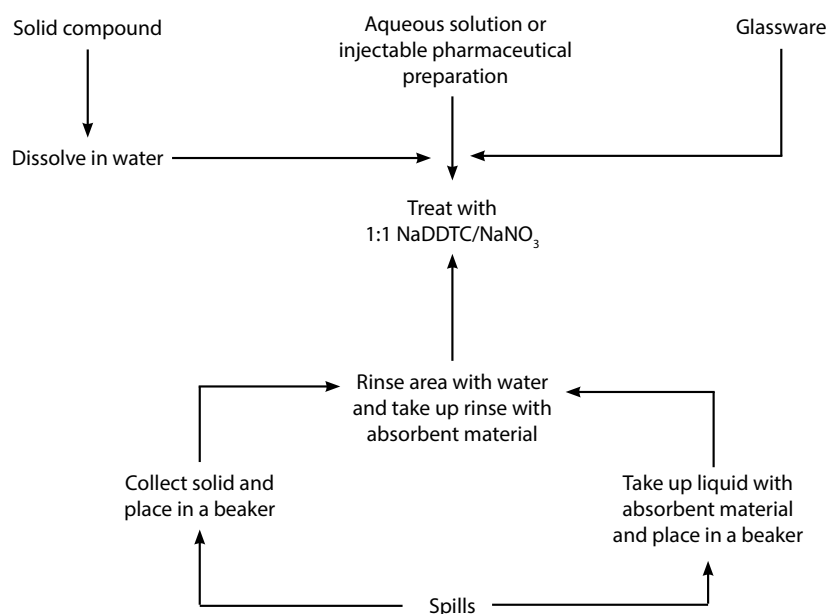

Figure A3.10 Schematic representation of procedure for destruction of cisplatin by reaction with sodium diethyldithiocarbamate

A3.11 Method 11: Destruction of procarbazine in laboratory wastes using potassium permanganate in sulfuric acid

A 25-mg quantity of procarbazine can be degraded by 5 ml of a 0.3 mol/ litre solution of potassium permanganate in 3 mol/litre sulfuric acid in 16 hours.

1. Reagents

- Potassium permanganate, technical grade
- Sulfuric acid (concentrated): relative density 1.84 (about 18 mol/litre)
- Sulfuric acid (dilute): 3 mol/litre, aqueous

Note: The dilution of concentrated sulfuric acid is an extremely exothermic reaction. Always add the acid to the water, never the reverse, and remove heat by cooling in a cold-water bath.

- Potassium permanganate: to 3 mol/litre sulfuric acid, add solid sulfuric acid solution: potassium permanganate to obtain a 0.3 mol/litre solution of potassium permanganate

Note 1: To avoid frothing, add the potassium permanganate in small increments.

Note 2: The reagent should always be freshly prepared on the day of use.

- Ascorbic acid, analytical grade.

2. Apparatus

- Standard laboratory equipment

3. Procedure (see Fig. A3.11)

3.1 Undiluted procarbazine

3.1.1 Dissolve the procarbazine in 3 mol/litre sulfuric acid to obtain a maximum concentration of 5 g/litre. (Sulfate precipitate might form but will redissolve after addition of potassium permanganate in 3.1.2.)

3.1.2 Add enough potassium permanganate to obtain a 0.3 mol/litre solution and to ensure that the purple colour remains after the reaction.

3.1.3 Allow to react overnight or longer.

3.1.4 Dilute with water and discard.

3.2 Aqueous solutions

3.2.1 Add slowly, with stirring, enough sulfuric acid to obtain a 3 mol/litre solution and a maximum procarbazine concentration of 5 g/litre.

3.2.2 Proceed as in 3.1.2 to 3.1.4.

3.3 Glassware

3.3.1 Rinse glassware with three successive portions of 3 mol/litre sulfuric acid solution. Drain completely between each rinse.

3.3.2 Treat rinses as in 3.1.2 to 3.1.4.

3.4 Spills of aqueous solutions

3.4.1 Isolate the area, and put on suitable protective clothing, including breathing apparatus if considered necessary. Add 3 mol/litre sulfuric acid solution to the spill area.

3.4.2 Take up the spill with an absorbent material, such as blotting paper; place it immediately in a beaker, and add a solution of 0.3 mol/litre potassium permanganate in 3 mol/litre sulfuric acid. Allow to react overnight or longer.

3.4.3 Pour some of the potassium permanganate/sulfuric acid solution over the contaminated area and allow to react overnight or longer; add some ascorbic acid to the area to clear the colour.

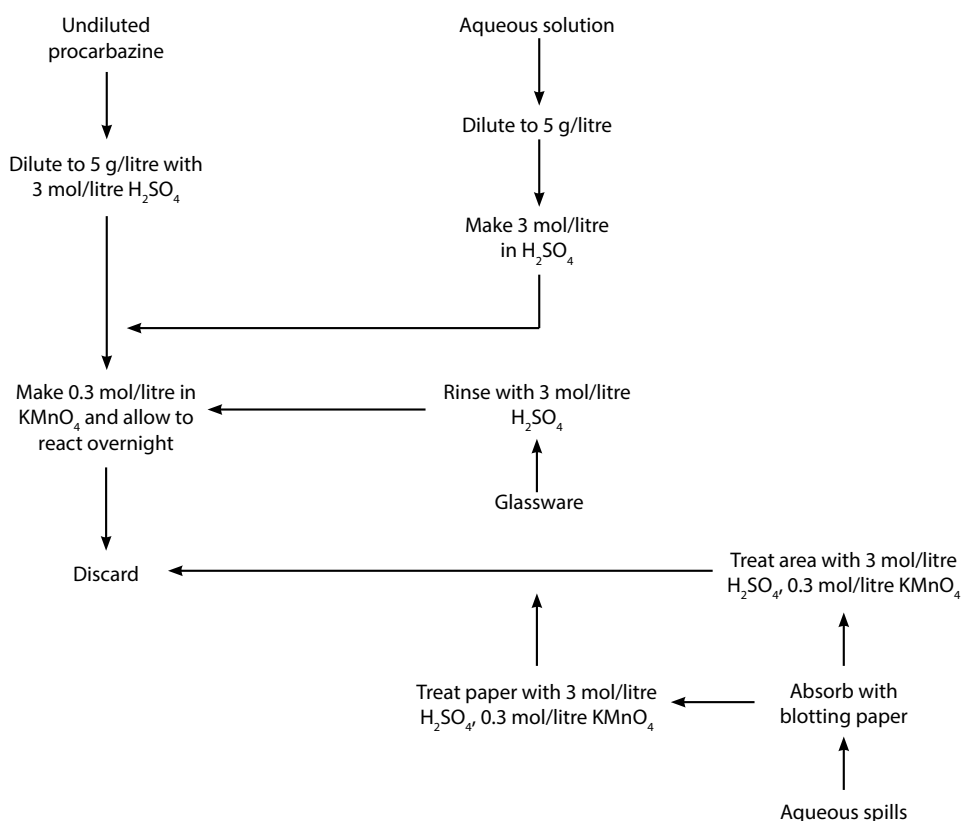

Figure A3.11 Schematic representation of procedure for destruction of procarbazine using potassium permanganate in sulfuric acid

A3.12 Methods of degradation of cytostatic drugs in hospital formulations

The three following degradation methods have been tested by a number of laboratories, coordinated by IARC, on 32 hospital formulations of cytostatic drugs (see Table A3.1). The efficiency of these methods is summarized in Table A3.2, which also indicates the mutagenic activity of the residues (tested using *Salmonella typhimurium* strains TA97, TA98, TA100 and TA102, with and without mutagenic activity). Degradation using sodium hypochlorite seems the most suitable method for these formulations.

Note: When reaction times were longer than those given in the following procedures, this is noted in Table A3.2.

Degradation by sodium hypochlorite

1. Measure the volume of the solution for administration of the cytostatic drug to be degraded.
2. Add an equivalent volume of a 5% sodium hypochlorite solution.
3. If necessary, shake to achieve complete homogeneity of the solution. (An ultrasound bath may be used for this purpose.)
4. Allow to react at room temperature for at least 1 hour.
5. If necessary, check for completeness of degradation.

6. Discard.

Degradation by hydrogen peroxide

1. Measure the volume of the solution for administration of the cytostatic drug to be degraded.
2. Add an equivalent volume of a 30% hydrogen peroxide solution.
3. If necessary, shake to achieve complete homogeneity of the solution. (An ultrasound bath may be used for this purpose.)
4. Allow to react at room temperature for at least 1 hour.
5. If necessary, check for completeness of degradation.
6. Dilute with water and discard.

Degradation by a Fenton reagent

1. Measure the volume of the solution for administration of the cytostatic drug to be degraded.
2. Place in a flask of at least 10 times the volume of solution to be degraded. Place the flask on ice.
3. Add slowly, with stirring, 0.3 g of ferrous chloride, $\text{FeCl}_2 \cdot 2\text{H}_2\text{O}$.
4. Add dropwise, with stirring, 10 ml of a 30% hydrogen peroxide solution.
5. Allow to react at room temperature for at least 1 hour.
6. If necessary, check for completeness of degradation.
7. Dilute and discard.

Table A3.1 Formulation of reconstituted and administration solutions of cytostatic drugs

Drug	Reconstituted solutions: solvents and additives		Drug concentration in reconstituted solution		Dilution for administration: diluent		Drug concentration in solution for administration	
	France	USA	France	USA	France	USA	France	USA
Aclarubicin 20 mg	Saline 0.9%		4 mg/ml		Saline 0.9% or glucose 5%		0.5 mg/ml	
Amsacrine 75 mg (contains 1.5 ml dimethyl acetamide)	Water 13.5 ml + (+)-lactic acid 42.93 mg	Water	5 mg/ml	5 mg/ml	Glucose 5%	Glucose 5%	0.15 mg/ml	0.15 mg/ml
Asparaginase	Water 2.5 ml + glycine 48.6 mg	Water	4000 U/ml	5000 U/ml	Saline 0.9% or glucose 5%	(no further dilution)	200 U/ml	5000 U/ml
Azathioprinea	Powder: lactose + starch + stearic acid +magnesium stearate	Water		10 mg/ml		Glucose 5%		2 mg/ml
Bleomycin 15 mg	Saline 0.9%, 5 ml	Water	3 U/ml	3 U/ml	Saline 0.9% or glucose 5%	(no further dilution)	0.05 U/ml or 3 U/ml	3 U/ml
Carboplatin	Water	Water	10 mg/ml	10 mg/ml	Saline 0.9%	Glucose 5%	1 mg/ml	0.5 mg/ml
Carmustine 100 mg	Ethanol (3 ml) + water (27 ml)	Water	3.3 mg/ml	33.3 mg/ml	Saline 0.9% or glucose 5%	Saline 0.9% or glucose 5%	0.2 mg/ml	0.5 mg/ml
Chlormethinea (mustine)	(Formulation contains 2 ml triethylene glycol)	Water	5 mg/ml	1 mg/ml	Saline 0.9% or glucose 5%	Saline 0.9% or glucose 5%	1 mg/ml	0.2 mg/ml
Cisplatin	Mannitol + saline + HCl (10%) to pH 4	Water	1 mg/ml	1 mg/ml	Saline	Saline	0.05 mg/ml	0.5 mg/ml
Cyclophos- phamide	Saline 0.9%	Water	20 mg/ml	20 mg/ml	Saline 0.9% or glucose 5%	Saline 0.9% or glucose 5%	1 mg/ml	4 mg/ml
Cytarabine	Water + methyl p-hydroxybenzoate	Water	20 mg/ml	100 mg/ml	Saline 0.9% or glucose 5%	Saline 0.9%	0.5 mg/ml	11 mg/ml

Table A3.1 *continued*

Drug	Reconstituted solutions: solvents and additives		Drug concentration in reconstituted solution		Dilution for administration: diluent		Drug concentration in solution for administration	
	France	USA	France	USA	France	USA	France	USA
Dacarbazine 100 mg + citric acid 100 mg + mannitol 50 mg	Water (10 ml)	Water	10 mg/ml	10 mg/ml	Saline 0.9%	Saline 0.9% or glucose 5%	0.02 mg/ml	4 mg/ml
Daunorubicin 20 mg + mannitol	Water	Water	5 mg/ml	5 mg/ml	Saline 0.9% or glucose 5%	(no further dilution)	20 mg/ml	5 mg/ml
Doxorubicin 10 mg + lactose 5 mg	Water	Water	2 mg/ml	5 mg/ml	Saline 0.9% or glucose 5%	Glucose 5%	10 mg/ml	400 mg/ml
Epirubicin 10 mg + lactose	Water or saline 0.9%		2 mg/ml		Saline 0.9% or glucose 5%		0.2–2 mg/ml	
Etoposide, 20 mg + citric acid, 2 mg + benzyl alcohol, 30 mg + polysorbate 80/Tween 80, 80 mg + PEG 300, 650 mg + alcohol 30.5%, pH 3–4			20 mg/ml	5 mg/ml	Saline 0.9% or glucose 5%	Saline 0.9% or glucose 5%	200 mg/ml	150 mg/ml

Table A3.1 continued

Drug	Reconstituted solutions: solvents and additives		Drug concentration in reconstituted solution		Dilution for administration: diluent		Drug concentration in solution for administration	
	France	USA	France	USA	France	USA	France	USA
Floxuridine	(not commercially available)	Water		100 mg/ml		Saline 0.9% or glucose 5%		0.3 mg/ml
Fludarabine ^a	Water	Water	25 mg/ml	10 mg/ml	Saline 0.9% or glucose 5%	Saline 0.9% or glucose 5%	1 mg/ml	0.4 mg/ml
5-Fluorouracil	Water (pH adjusted to 8.6–9.4 with NaOH)	Water (pH adjusted to 8.6–9.4 with NaOH)	50 mg/ml	50 mg/ml		(no further dilution)	0.01–40 mg/ml	50 mg/ml
Idarubicin ^a 5 mg + lactose 50 mg	Water or saline 0.9%	Water	1 mg/ml	1 mg/ml	Saline 0.9% or glucose 5%	Saline 0.9% or glucose 5%	0.5 mg/ml	40 mg/ml
Ifosfamide	Water	Water	71.4 mg/ml	50 mg/ml	Saline 0.9% or glucose 5%	Saline 0.9% or glucose 5%	1 mg/ml	27 mg/ml
Lomustine – used without dilution. Contains: 40 mg/capsule lactose, talc, magnesium stearate								
6-Mercaptopurine – administered orally		Water		10 mg/ml		Saline 0.9% or glucose 5%		1 mg/ml
Methotrexate	Water + methyl p-hydroxybenzoate + propyl p-hydroxybenzoate	Water	2.5 mg/ml	100 mg/ml	Glucose 5%	Saline 0.9% or glucose 5%	0.5 mg/ml	2 mg/ml
Pirarubicin 10 mg + HCl 1 mol/ litre + NaOH 0.2 mol/ litre + lactose	Water (adjusted to 5 ml)		2 mg/ml		Glucose 5%		1 mg/ml	

Table A3.1 *continued*

Drug	Reconstituted solutions: solvents and additives		Drug concentration in reconstituted solution		Dilution for administration: diluent		Drug concentration in solution for administration	
	France	USA	France	USA	France	USA	France	USA
Streptozocin 1 g + citric acid 220 mg	Saline 0.9% or glucose 5%, 9.5 ml	Water	100 mg/ml	100 mg/ml	Saline 0.9% or glucose 5%	Saline 0.9% or glucose 5%	0.1 mg/ml	14 mg/ml
Teniposide 50 mg + benzyl alcohol + dimethyl- acetamide + castor oil + ethanol	Non-aqueous solvent to 5 ml		10 mg/ml	10 mg/ml	Saline 0.9% or glucose 5%	Saline 0.9% or glucose 5%	0.5 mg/ml	1.8 mg/ml
Thiotepa 10 mg (contains saline and NaHCO ₃)	Water	Water	5 mg/ml	10 mg/ml	Saline 0.9% or glucose 5%	Glucose 5%	1 mg/ml	0.06 mg/ml
Vinblastine sulfate 10 mg	Saline 0.9% or glucose 5%	Saline 9 mg in 1 ml of 0.9 % benzyl alcohol in water, pH adjusted to 3.5–5.0	1 mg/ml	1 mg/ml	Saline 0.9% or glucose 5%	(no further dilution)	0.17 mg/ml	1 mg/ml
Vincristine sulfate 1 mg + methyl p-hydroxybenzoate 1.275 mg + propyl p-hydroxybenzoate 0.225 mg + acetic acid 0.2 mol/litre	Water (adjusted to 1 ml)	1.3 mg methylparaben in 1 ml water adjusted to pH 3.5–5.5	1 mg/ml	1 mg/ml	Saline 0.9% or glucose 5%	(no further dilution)	0.17 mg/ml	1 mg/ml
Vindesine sulfate 1 mg + mannitol 5 mg	Water		0.25 mg/ml		Saline 0.9% or glucose 5%		0.001 mg/ml	
Vinorelbine sulfate 10 mg	Water		10 mg/ml		Saline 0.9% or glucose 5%		0.1 mg/ml	

g = gram, mg = milligram, ml = millilitre, mol = mole, U = unit, USA = United States of America

^a Only the USA formulations were tested.

Note: After reconstitution of the drugs listed in this table, many are further diluted for administration to patients. However, the extent of this further dilution varies from country to country, as is evident from this table, which gives details for formulations used in France and the United States of America. The degradation methods given in this annex were tested on these formulations, in each instance using the "worst case" (i.e. the stronger solution for administration) whenever there was a difference in national practice. It should be noted that the efficiency of degradation may be reduced if a particular method is used for a more concentrated formulation of a given drug.

Table A3.2 Efficiency of the degradation methods tested on 32 cytostatic drug formulations

Drug	Degradation by sodium hypochlorite		Degradation by hydrogen peroxide		Degradation by Fenton reagent	
	Degradation	Mutagenicity	Degradation	Mutagenicity	Degradation	Mutagenicity
Aclarubicin	+	-	-		+	-
Amsacrine	+	-	-		+	-
Asparaginase	+	-	+	-	+	-
Azathioprine	+	-?	-		+	-
Bleomycin, 10 mg/ml	+	-	-		+/- ^a	+/- ^a
Carboplatin	+	-	+	-		
Carmustine:						
• 1 hour	+	+	+	-/Toxic	+	+
• 4 hours	+	-	+	-/Toxic	Not tested	
Chlormethine (mustine)	+	-	-		-	
Cisplatin	+	-	+	- (+) ^b	+	-
Cyclophosphamide	+	-	+	-	+	- (+) ^c
Cytarabine	+	-	+	-	+	-
Dacarbazine, 10 mg/ml	+	+	-		+/- ^d	+/- ^d
Dacarbazine, 4 mg/ml	+	-	Not tested		+	+/-
Daunorubicin	+	-	-		+	-
Doxorubicin	+	-	-		+	-
Epirubicin	+	-	+	-	+	-
Etoposide	+	-	-		+	+
Floxuridine	+	-	+	-	+	-
Fludarabine	+	-	+	-	+	-
5-Fluorouracil	+	-	+	Toxic	+	-
Idarubicin	+	-	-		+	-
Ifosfamide	+	-	+	- (+) ^c	+	-
Lomustine, 5 mg/ml:						
• 1 hour	+	+	+	T ^f	+ ^g /-	- ^g
• 4 hours	+	-	+	T ^f	Not tested	
Lomustine, 1 mg/ml:						
• 1 hour	+	-	+	T ^f	+	-
• 4 hours	+	-	+	T ^f	Not tested	
6-Mercaptopurine	+	-	+	-	+	-
Methotrexate	+	-	+	-	+	-
Pirarubicin	+	-	+ ^h	-	+	-
Streptozocin:						
• NaCl, 0.9%	+	-	+	-	+	-/+
• glucose, 5%	+	-	+	-	+/- ⁱ	+ ⁱ
Teniposide	+	- (+) ^c	-		+	-

Table A3.2 continued

Drug	Degradation by sodium hypochlorite		Degradation by hydrogen peroxide		Degradation by Fenton reagent	
	Degradation	Mutagenicity	Degradation	Mutagenicity	Degradation	Mutagenicity
Thiotepa	+	–	+	–	+	–
Vinblastine sulfate	+	+	+	–	+	+
Vincristine sulfate	+	–	–	–	+	–
Vindesine sulfate	+	–	–	–	+	–
Vinorelbine sulfate	+	–	–	–	+	–

a Residual concentration after degradation, 1.48%.

b Mutagenic activity detected for a United States formulation, which was 10 times stronger than a French formulation also tested.

c Mutagenic activity detected when the reaction was performed in the presence of 5% glucose.

d Residual concentration after degradation, 0.04%.

e This drug is formulated as a powder; two concentrations were tested after dilution (5 and 1 mg/ml).

f Toxic activity detected, which may have resulted from a problem in preparation of the sample for mutagenicity testing.

g In one experiment, 1.22% residual drug was detected; the sample tested for mutagenicity was >99.5% degraded.

h A reaction time of 24 hours was found necessary for efficient degradation.

i Residual concentration after degradation, 0.7%.

References

American Society of Hospital Pharmacists (1990). ASHP technical assistance bulletin on handling cytotoxic and hazardous drugs. *American Journal of Hospital Pharmacy*, 47, 1033–49.

Anderson RW, et al. (1982). Risk of handling injectable antineoplastic agents. *American Journal of Hospital Pharmacy*, 39, 1881–1887.

Centers for Disease Prevention and Control (2000). *Primary containment for biohazards: selection, installation and use of biological safety cabinets*. (www.cdc.gov/od/ohs/biosfty/bsc/bsc.htm)

Connor TH, et al. (2002). Effectiveness of a closed-system device in containing surface contamination with cyclophosphamide and ifosfamide in an IV admixture area. *American Journal of Health System Pharmacy*, 59: 68–72.

Goodin S, et al. (2011). Safe handling of oral chemotherapeutic agents in clinical practice: recommendations from an international pharmacy panel. *Journal of Oncology Practice*, 7:7–8.

Harrison BR (2001). Risks of handling cytotoxic drugs. In M.C. Perry (Ed.), *The chemotherapy source book*. (3rd Ed., pp. 566–582). Philadelphia, Pennsylvania, Lippincott, Williams, & Wilkins.

Jones RB, Frank R, Mass T (1983). Safe handling of chemotherapeutic agents: a report from the Mount Sinai Medical Center. *Ca-A Cancer Journal for Clinicians*. *American Cancer Society*, 33:257–263.

Knowles RS and Virden JE (1980). Handling of injectable antineoplastic agents. *British Medical Journal*, 281:589–591.

National Institute for Occupational Safety and Health (2004). *Preventing occupational exposures to antineoplastic and other hazardous drugs in healthcare settings*. US DHHS PHS, NIH Pub. No. 92-2621. (www.cdc.gov/niosh/docs/2004-165/pdfs/2004-165.pdf)

Polovich M (2004). Safe handling of hazardous drugs. *Online Journal of Issues in Nursing*. Vol. 9 No. 3, Manuscript 5. (www.nursingworld.org/MainMenuCategories/ANAMarketplace/ANAPeriodicals/OJIN/TableofContents/Volume92004/No3Sept04/HazardousDrugs.aspx)

Solimando DA (1983). Preparation of antineoplastic drugs: A review. *American Journal of Intravenous Therapy & Clinical Nutrition*, September: 16–27.

Stolar MH, Power LA, Viele CS (1983). Recommendations for handling cytotoxic drugs in hospitals. *American Journal of Hospital Pharmacy*, 40, 63–71.

Zimmerman PF et al. (1981). Recommendations for the safe handling of injectable antineoplastic drug products. *American Journal of Hospital Pharmacy*, 38:1693–1695.

Further reading

Barek J et al. (1998). Chemical degradation of wastes of antineoplastic agents. Part 3: amsacrine, azathioprine, asparaginase and thiotepa. *Annals of Occupational Hygiene*, 42:259–266.

Castegnaro M et al. (1997). Chemical degradation of wastes of antineoplastic agents. Part 2: six anthracyclines: idarubicin, doxorubicin, epirubicin, pirarubicin, aclarubicin and daunorubicin. *International Archives of Occupational and Environmental Health*, 70:378–384.

Hansel S et al. (1997). Chemical degradation of wastes of antineoplastic agents. Part 1: cyclophosphamide, ifosfamide, melphalan. *International Archives of Occupational and Environmental Health*, 69:109–114.

A4 Clearance levels for radioactive waste

The material in this annex has been produced by the International Atomic Energy Agency (IAEA) and is based on extracts from the following two publications, used with permission:

IAEA (1996). *Clearance levels for radionuclides in solid materials*. TECDOC 855. Vienna, International Atomic Energy Agency.

IAEA (1999). *Clearance of materials resulting from the use of radio-nuclides in medicine, industry and research*. Vienna, International Atomic Energy Agency.

Table A4.1 Generic clearance levels for solid waste

Radionuclide	Clearance level (Bq/g) for moderate quantities
H-3	1×10^6
C-14	1×10^4
Na-22	1×10^1
Na-24	1×10^1
P-32	1×10^3
S-35	1×10^5
Cl-36	1×10^4
K-42	1×10^2
Ca-45	1×10^4
Ca-47	1×10^1
Cr-51	1×10^3
Fe-59	1×10^1
Co-57	1×10^2
Co-58	1×10^1
Ga-67	1×10^2
Se-75	1×10^2
Sr-85	1×10^2
Sr-89	1×10^3
Y-90	1×10^3
Mo-99	1×10^2
Tc-99	1×10^4
Tc-99m	1×10^2
In-111	1×10^2
I-123	1×10^2

Table A4.1 *continued*

Radionuclide	Clearance level (Bq/g) for moderate quantities
I-125	1×10^3
I-131	1×10^2
Pm-147	1×10^4
Er-169	1×10^4
Au-198	1×10^2
Hg-197	1×10^2
Hg-203	1×10^2
Tl-201	1×10^2
Ra-226	1×10^1
Th-232	1×10^0

Note: The generic clearance levels in Table A4.1 are given for moderate quantities of waste (i.e. less than 3 tonnes of cleared waste per year and per facility). They are identical to the exemption levels of the international basic safety standards for protection against ionizing radiation and for the safety of radiation sources (IAEA, 1996). Clearance levels for large quantities are one tenth of the levels in Table A4.1.

Table A4.2 Liquid discharge rates to sewers, rivers or other large water bodies

Radionuclide	Annual release rate (Bq/year)	Monthly release rate (Bq/month)	Daily release rate (Bq/day)
H-3	10^9	10^8	10^7
C-14	10^7	10^6	10^5
Na-22	10^2	10	1
Na-24	10^5	10^4	10^3
P-32	10^3	10^2	10
S-35	10^6	10^5	10^4
Cl-36	10^7	10^6	10^5
Ca-45	10^7	10^6	10^5
Ca-47	10^5	10^4	10^3
Fe-59	10^3	10^2	10
Co-57	10^6	10^5	10^4
Co-58	10^5	10^4	10^3
Ga-67	10^5	10^4	10^3
Sr-85	10^3	10^2	10^3
Sr-89	10^6	10^5	10^4
Y-90	10^7	10^6	10^5
Mo-99	10^5	10^4	10^3
Tc-99	10^7	10^6	10^5
Tc-99m	10^6	10^5	10^4
In-111	10^5	10^4	10^3
I-123	10^6	10^5	10^4
I-125	10^5	10^4	10^3
I-131	10^5	10^4	10^3
Pm-146	10^7	10^6	10^5

Table A4.2 continued

Radionuclide	Annual release rate (Bq/year)	Monthly release rate (Bq/month)	Daily release rate (Bq/day)
Er-169	10 ⁷	10 ⁶	10 ⁵
Au-198	10 ⁵	10 ⁴	10 ³
Hg-197	10 ⁶	10 ⁵	10 ⁴
Hg-203	10 ⁴	10 ³	10 ²
Tl-201	10 ⁵	10 ⁴	10 ³
Ra-226	10 ³	10 ²	10
Th-232	10 ³	10 ²	10

Note 1: Table A4.2 provides annual release rates below which water-miscible liquid waste may be unconditionally discharged with normal wastewater by a pipe to a sewer, river or other large water body. Since it would not necessarily be appropriate for the whole discharge to be made over a very short time, both monthly and daily limits have also been included. These are based on 1/10 and 1/100 of the annual limits, respectively.

Note 2: The derivation of clearance levels for liquid releases is described elsewhere (IAEA, 1999). For discharge to sewers, two extreme possible scenarios were considered: (a) no radioactive material is retained in sewage sludge but all is discharged to the water body in liquid form; and (b) all radioactive material discharged is retained in the sewage sludge at the sewage treatment works. Radiation doses were calculated for both cases, and the more restrictive levels were used to derive the values in Table A4.2, after being divided by a conservative factor of 1000. This factor is intended to reflect the fact that (a) the models in the reference document (IAEA, 1999) were developed for application in temperate European and North American conditions, and the assumptions of diet, agriculture and lifestyle may not be universally valid; and (b) these models did not consider the transfer of radionuclides to terrestrial food chains as a result of irrigation or use of sewage sludge in agriculture.

Note 3: Activity from patients' discharges, after diagnostic or therapeutic use of radionuclides, should also be considered. This may be achieved by comparing discharges with the clearance levels.

Note 4: For other radionuclides and higher levels of activity, any discharge made should be specifically authorized by the regulatory authority after assessment of all the relevant conditions.

Note 5: In reality, more than one radionuclide will often be involved. To determine whether a mixture of radionuclides is at or below the clearance level, a simple ratio expression can be used:

$$\sum_{i=1}^n \frac{C_i}{C_{Li}} \leq 1$$

where C_i is the concentration of radionuclide i in the material being considered (Bq/g), C_{Li} is the clearance level of radionuclide i in the material (Bq/g); and n is the number of radionuclides in the mixture.

Table A4.3 Gaseous releases into the open air

Radionuclide	Annual release rate (Bq/year)
H-3	10 ⁸
C-14	10 ⁷
Na-22	10 ³
Na-24	10 ⁶
P-32	10 ⁵
S-35	10 ⁵
Cl-36	10 ⁴
K-42	10 ⁷
Ca-45	10 ⁵
Ca-47	10 ⁶
Cr-51	10 ⁶
Fe-59	10 ⁵

Table A4.3 *continued*

Radionuclide	Annual release rate (Bq/year)
Co-57	10 ⁶
Ga-67	10 ⁷
Se-75	10 ⁵
Co-58	10 ⁶
Sr-85	10 ⁵
Sr-89	10 ⁵
Y-90	10 ⁷
Mo-99	10 ⁶
Tc-99	10 ⁴
Tc-99m	10 ⁸
In-111	10 ⁶
I-123	10 ⁷
I-125	10 ⁵
I-131	10 ⁵
Xe-127	10 ⁸
Xe-133	10 ⁹
Pm-147	10 ⁷
Er-169	10 ⁷
Au-198	10 ⁶
Hg-197	10 ⁷
Hg-203	10 ⁵
Tl-201	10 ⁷
Ra-226	10 ³
Th-232	10 ²

Note 1: Table A4.3 provides annual release rates below which gaseous waste may be unconditionally discharged via ventilation systems (e.g. from laboratory fume cupboards) or other means to the open air. This may be done only in such a way and in such a position as to prevent the gas from re-entering any building.

Note 2: The derivation of clearance levels for gaseous releases is described elsewhere (IAEA, 1999). It assumes that a person lives 20 m from the release point and obtains all crop-based foods from an area at least 100 m from the release point and all animal products from an area at least 800 m from the release point. Values in Table A4.3 were then based on radiation doses calculated from the summation of inhalation, injection and external exposure pathways. The values in the table include a conservative factor of 1000 to reflect the fact that the models in the reference document (IAEA, 1999) were developed for temperate European and North American conditions and may differ for countries with significantly different diets, agriculture and lifestyles.

Note 3: For other radionuclides and higher levels of activity, any discharge should be specifically authorized by the regulatory authority after assessment of all the relevant conditions.

A5 Accidental contamination by mutagenic and carcinogenic products

The text of this annex has been reproduced, with minor editorial changes, from the following document:

WHO (1998). *Laboratory handling of mutagenic and carcinogenic products*. Unpublished document WHO/PCS/ 98.9; IPCS Training Module No. 2. Geneva, World Health Organization.

An accident involving contamination by a mutagenic or carcinogenic substance must be systematically planned for because it can affect the entire staff of a laboratory and the equipment. The substance in question may arise in a number of forms (liquid, solid, gas, volatile product, aerosol, etc.) and every eventuality must be catered for.

In every case:

- emergency exits must be signposted, and emergency telephone numbers (poison control centre, fire service, ambulance service, medical centre) must be prominently displayed;
- the emergency services must be notified of the existence of the hazard and of the proposed protocol;
- emergency equipment must be on hand, and trained first aiders must be available.

A5.1 Immediate action

In every case, responsible persons, whose names and telephone numbers are clearly displayed on the door to the premises concerned, must be informed.

It is the responsibility of the supervisor to notify the medical service, which must record the accident in the register of accidents at work and contact outside services, if necessary, together with the health and safety committee/works council.

The immediate action taken by the supervisor has a number of objectives:

- to evacuate personnel quickly in accordance with a pre-arranged plan if the contamination is caused by a gas, volatile product, aerosol, powdery solid or liquid;
- to avoid air currents: doors must be closed and ventilation hoods switched off if the contaminant is a powder;
- to restrict access to the contaminated area;
- to organize prompt decontamination of exposed personnel using appropriate methods;
- to organize prompt decontamination of the premises and exposed equipment.

Adequate precautions must be taken to prevent contamination of premises, equipment and individuals as far as possible.

A5.2 Evacuation of personnel

Personnel must be evacuated very promptly in serious cases of major contamination and where the contaminating product may easily disperse (in the case of gases, volatile products or aerosols). This evacuation may require the assistance of persons from outside, wearing protective clothing appropriate to the scale and type of contamination (gloves, goggles, cellulose mask, cartridge mask, self-contained breathing apparatus, overalls).

A5.3 Decontamination of personnel

Any signs of acute intoxication and/or of a life-threatening condition (injuries, breathing difficulties) must be attended to immediately. Thereafter, and depending on the type of contamination, there are a number of possible scenarios; in every case, clothing that has been soiled or is thought to have been soiled must be removed for decontamination and placed in special sacks.

A5.3.1 Contamination of the skin and mucosa

Copious and immediate washing must be carried out on the spot for 20 minutes using cold or tepid water delivered by a shower, eye bath or any other suitable method.

Never rub or scrub and never use a solvent, including alcohol, which may facilitate penetration of the contaminant through the skin.

The contaminant is diluted by this first rinsing, and the rinse water must be discarded together with mutagenic waste.

If the suspect products are lipophilic (solubility in water <0.1%), mild detergents may be used on the skin to complete the decontamination. Use of detergents, however, must remain the exception, because they can make it easier for the contaminant to penetrate the skin or mucosa, and they should never be used as the method of first resort.

In severe cases, contamination may be continued in hospital, where any systemic effects can be treated.

A5.3.2 Absorption by mouth

The process of decontamination follows medical or hospital practice (poison control centres). The mouth may, however, be rinsed out on the spot if the affected individual is conscious.

Never induce vomiting in an accident victim.

A5.3.3 Inhalation

Individuals affected by inhalation of a contaminant should be evacuated immediately to a non-contaminated area; the process of decontamination will then require the attention of specialist personnel. Treatment of the toxic effects of the contaminant may require hospitalization.

A5.4 Decontamination of premises and equipment

In every case of contamination:

- the safety service must be notified;
- the contaminated area (floors, bench tops, etc.) must be marked off and isolated using a marker or adhesive tape;
- appropriate protective clothing must be put on (gloves, cellulose mask or cartridge mask or self-contained breathing apparatus, overalls);
- nothing must be picked up with the bare hands; decontamination must be carried out.

A5.4.1 When the contaminant is a liquid

Absorbent products (e.g. a universal drying agent) may be spread over the soiled surfaces. These absorbent products must then be disposed of in receptacles set aside for genotoxic materials. The affected area should then be copiously washed and rinsed using a solvent appropriate to the contaminant; rinsing and washing liquids should be disposed of as mutagenic effluent. The final rinsing liquid should be tested for mutagenicity (using a chemical analysis, which is faster than the mutagenicity test), and access to the contaminated area must be prohibited until test results are known.

In every case, solutions must be wiped up working from the outside edge of the soiled area in towards the point of first impact to prevent the hazardous product from spreading. These operations must be performed by a properly protected and competent individual.

A5.4.2 When the contaminant is a powder

All forms of ventilation must be switched off to reduce the risk of dispersion, and the contaminated area must be cleaned using paper or a cloth impregnated with solvent. Filters must be changed after decontamination. The contaminated area must be covered by a cloth or compresses soaked in water or a neutralizing solution to prevent the generation of particulates that can be inhaled.

Premises and equipment may also be decontaminated using a wet method – initially, specific solvents, decontaminants, or detergents in an aqueous solution or soapy water. Solvents, decontaminants or detergents should be spread on absorbent paper and discarded after use into the receptacles reserved for toxic substances. Surfaces should be copiously rinsed before the premises are used again.

In every case, solutions must be wiped up working from the outside edge of the soiled area in towards the point of first impact to prevent the hazardous product from spreading.

Small equipment of low cost may be disposed of without cleaning; alternatively, it should be decontaminated using the method described above.

Clothing contaminated by accident or used during cleaning must be incinerated.

A5.5 Emergency standby equipment

An eye-bath and a shower should be available near a laboratory that uses mutagenic products.

A stock of latex gloves, cellulose masks, self-contained breathing apparatus, overalls, paper, disposable hooded coats, overshoes and drying agents must be available to personnel. Ideally, a special spill control kit containing the various items of equipment needed should be assembled.

Lastly, it is vital to have a telephone in the immediate vicinity, with the telephone numbers of the supervisor, medical service, fire service, ambulance service, poison control centre, etc. prominently displayed. This must not be located in the laboratory itself, but in the corridor outside, for example.

A5.6 Acts of vandalism, theft, fire, flood

Procedures must be geared above all to prevention of accidents/incidents. However, the laboratory supervisor must be notified at once of any incident so that appropriate action can be taken. Information must be given at once to emergency teams that may have to be brought in from outside. All personnel must be made aware of any theft or act of vandalism; details should be posted so that everyone is informed of the hazards involved.

A5.7 Notification of accidental contamination

Accidental contamination must be notified using a standard-format document, a copy of which must in every case be sent to the medical service. The document must state:

- the day and date of the accident
- the names of the persons concerned, including those who helped in the decontamination work
- the premises and equipment contaminated
- the name of the product that caused the contamination, its volume, presentation, and concentration
- a description of the operations that resulted in the accident
- a description of the actions taken after the accident.

All these details must be entered in the safety register.

A5.8 Responsibility

The laboratory supervisor has a duty to inform persons handling products that are known or suspected mutagens and/or carcinogens of the potential hazards.

Specific procedures must be available for personnel to follow.

In the event of an accident, a subsequent inquiry must determine the causes of the accident and establish means of ensuring that recurrences can be prevented.

A6 Disposal of pathological waste

Note: This annex is adapted from Médecins Sans Frontières (2010).

Treating and disposing of biodegradable pathological waste is a critical problem for many health-care facilities. The general approach for managing this type of waste is outlined in Chapter 8. This annex describes some alternative approaches, which may be relevant if incineration, cremation and advanced non-incineration technologies applicable to pathological waste (such as alkaline digestion and hybrid steam treatment systems with internal shredding) are not available, and if the pathological waste must be treated or disposed of within the compound of the health-care facility. Under no circumstances should live cultures be treated in this manner. Instead, live cultures should be disinfected in the laboratory before being sent for disposal.

Organic waste often contains too many liquids to be suitable for incineration with volume reducers or batch auto-combustion incinerators. The temperature reduction due to the evaporation of the liquids will result in formation of more toxic gases, survival of potential thermoresistant pathogens or even bringing the combustion to a halt.

Much research has focused on the elimination of enteric or waterborne pathogens in various types of composting system, both aerobic and anaerobic. As yet, there has been no comparable research for bloodborne pathogens or pathogens involved in hospital-acquired infections; however, the risk appears to be lower than that for enteric infections. Firstly, the likelihood of bloodborne or hospital-acquired pathogens surviving composting is lower than that for waterborne infectious agents. Viruses and bacteria that cannot form spores are likely to be inactivated in a short period, although bacterial spores are more resistant. Biodigestion processes with higher temperatures and longer residence times are considered to be the best at eliminating pathogens.

In any waste-disposal approach, care should be taken to prevent contact with untreated waste, such as through skin contact or splashes during collection and placement of the waste into pits, composters, digesters, and so on.

Enteric pathogens can cause infection through the usual cycle of infection – for example, someone handling compost from a digestion process may get material on their hands and then spread it to their mouth. Conversely, bloodborne pathogens are unlikely to be spread via this usual cycle of infection; it is very unlikely that someone would pick up any bloodborne pathogen by handling compost or biodigester slurry unless the worker has cuts or breaks in the skin, or there are sharps in the waste causing injury to the workers.

A6.1 Placenta pit

In many communities, burying placentas is an important ritual and one option for disposal. If it is done safely, burial can protect the community from pathogens while respecting cultural norms and religious traditions.

One disposal option is to dispose of placentas in concrete pits (Figure A6.1). The site of the pits should be as far away as possible from publicly accessible areas and from hygienically critical areas (e.g. water wells, kitchens). Placenta pits should not be built too close to buildings due to possible odours.

The dimensions of the pit will be context specific, and will depend on the average number of births and infiltration rate of the soil. In principle, allow 0.5 litres of soil infiltration per placenta, and a maximum of 5 litres of total space per placenta if all the bloody liquids are collected and no infiltration is occurring.

The liquid proportion of placentas can leach into the soil through the unsealed sides of the pit. However, the pit

should be designed to prevent the waste from contaminating the surrounding groundwater. A safety distance of at least 1.5 m from the bottom of the pit to the groundwater level is recommended. Placenta pits are not recommended in sites where the water table is near the surface or in areas prone to flooding.

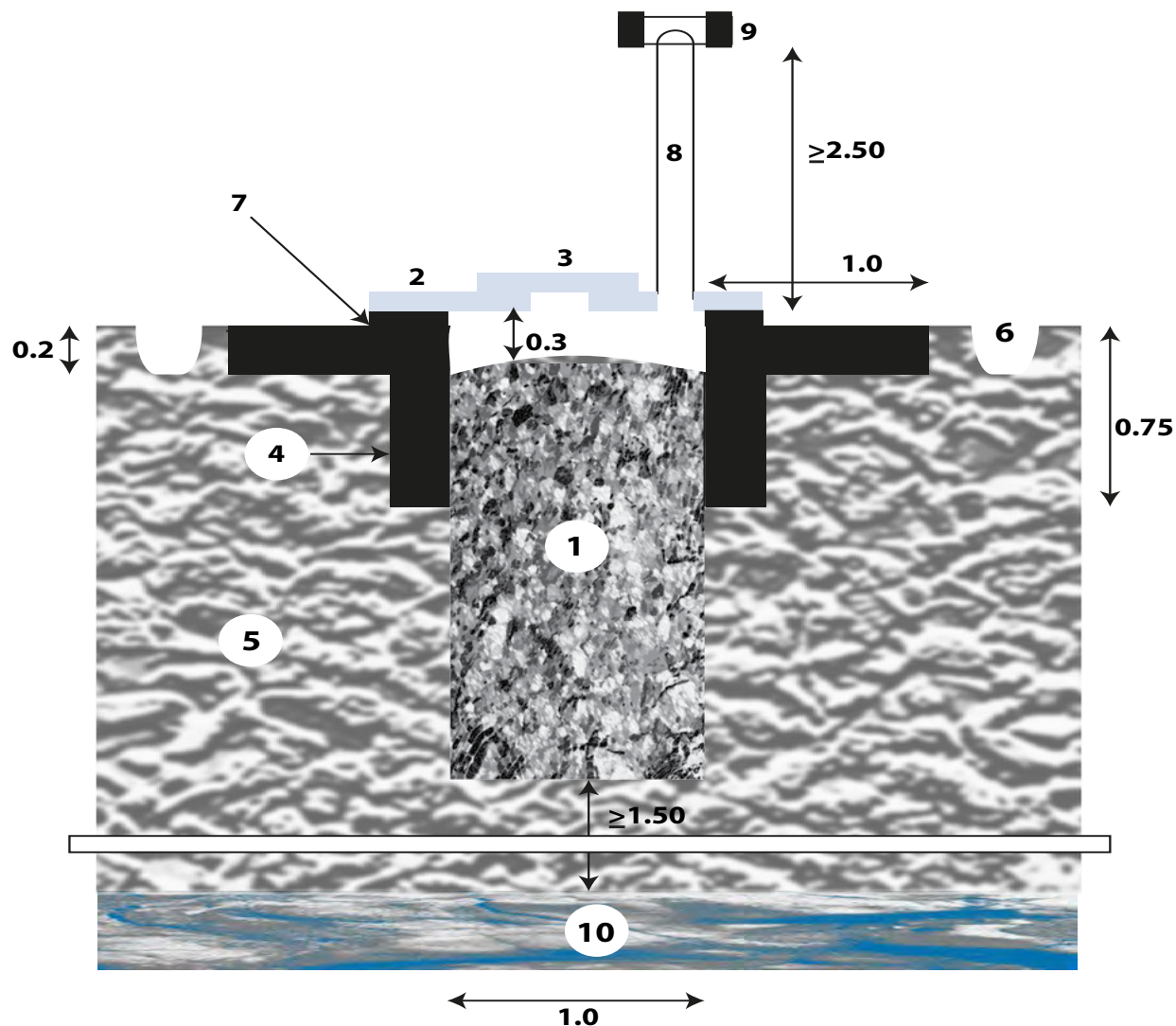

The top 50 cm (or more) of the pit should be reinforced with concrete to prevent surface water infiltration. The base of the pit should be made from concrete to stabilize the structure and to slow the downward movement of liquid towards the water table. Placenta pits can be also constructed from a standard concrete ring with a diameter of about 1 m. The top slab should be above ground level and made from watertight concrete to prevent surface water infiltration. The top should be closed by a lockable hatch and a vent pipe installed to ensure that the generated gases can escape and air can get in. Where soil is particularly sandy, extra precautions may need to be taken to protect the water table and to prevent the pit from collapsing: the sides may be reinforced with bricks, laid with gaps between them so that the liquids can still escape.

1. Pit: string line, sticks and measuring tape
2. Slab: shovel, hoe, pick axe, miner's bar
3. Lid: fired bricks or cement blocks
4. Base or lining: sand, cement, gravel and clean water
5. Permeable soil: reinforcement bars (diameter 8 mm)
6. Drainage channel: tools to prepare and cast concrete; masons' tools
7. Mortar layer (at least 10 mm thick): jute sacking or plastic sheeting
8. Ventilation pipe: prefabricated slab with lid
9. Tee with mosquito netting: protective clothing for operators
10. Water table: polyvinyl chloride (PVC) pipe (preferably diameter 150 mm), piece of stainless steel or nylon mosquito net

Dimensions are indicated in metres; labour requirements are for an experienced mason and one or two labourers

Source: Médecins Sans Frontières (2010)

Figure A6.1 Example of a placenta pit

It is recommended that two placenta pits are built so that the second one is available as soon as the first is filled. Once a pit is filled up, it should be closed. Any sealed pits should be marked and their locations recorded. However, it may be possible to reopen pits after enough time has passed and the material has been degraded. When pits are reopened, it may be necessary to remove some of the degraded material. In this case, the concrete bottom of the pit has the added advantage that it will prevent workers digging too deeply and either destabilizing the pit or getting too close to the water table.

The process of biodegradation in the pit can destroy pathogenic microorganisms as the waste is subjected to changes in temperature, pH and a complex series of chemical and biological reactions. The degradation processes in a pit are anaerobic, with some aerobic decomposition in the upper layers where oxygen is available for aerobic bacteria. The waste should not be treated with chemical disinfectants such as chlorine before being disposed of, because these chemicals destroy the microorganisms that are important for biological decomposition.

At present, few data are available on how long it will take for all pathogens and eggs to die – particularly because the decomposition process depends on the local conditions (e.g. surrounding temperatures). Therefore, it is recommended that placenta pits should remain for at least two years before reopening. More research is needed on this subject.

Ash or charcoal helps reduce odours without adversely affecting the decomposition. Although adding lime will help to reduce odours, it will increase the pH of the soil and thereby slow the rate of decomposition, and therefore is not recommended. Adding ash will also reduce odours and decrease soil pH. It will also correct the carbon to nitrogen (C:N) ratio and speed up decomposition.

The operation of a placenta pit is based on the following steps and principles (MSF, Technical Brief 6.08):

- Dispose of the organic waste into the pit immediately when it arrives at the waste zone. Use only one pit at the time. Make sure that the pits are always closed with the slab's lid.
- Disinfect the empty organic waste bins with a 0.1% chlorine solution, rinse them with clean water, and finally clean them with water and soap. Never mix chlorine and soap together.
- Close the pit down when the level of the organic waste is about 0.5 m underneath the slab. Put a thick layer of wood ash on top of the organic waste and top up with compacted soil if the pit is closed permanently. Do not use ash from burnt soft waste for this purpose. Most organic waste will decompose into harmless matter, so it is normally possible to empty a pit that has been closed down for at least two years. However, be aware that bones of amputated limbs will still be intact. The general public may find the removal of these remainders offensive. Take particular care to avoid injuries with sharps that have accidentally been discarded in the organic waste pit. A new permanent burial place should be found for the organic waste remainders, potentially a controlled tip or a sanitary landfill.

A6.2 Aerobic composting

Composting is an aerobic treatment method for biodegradable waste. Aerobic bacteria that thrive in an oxygen-rich environment break down waste primarily into carbon dioxide, water, ammonia, and a dark earthy mixture (compost) that can be used to enrich soil. Composting organisms require four equally important things to work effectively:

- carbon – for energy; the microbial oxidation of carbon produces heat
- nitrogen – to grow and reproduce more organisms to oxidize the carbon
- oxygen – for oxidizing the carbon; the decomposition process
- water – in the right amounts, to maintain activity without causing anaerobic conditions.

Certain ratios of these materials provide beneficial bacteria with the nutrients to work at a rate that will heat up the compost pile. Since water is released as vapour and the oxygen is depleted, the pile must be actively managed. The

hotter the pile gets, the more often air and water are added; the air–water balance is critical to maintaining high temperatures (75–80 °C) until the materials are broken down. At the same time, too much air or water also slows the process, as does too much carbon (or too little nitrogen). The heat destroys pathogens at 55 °C and higher.

The C:N ratio is of paramount importance. The optimal C:N ratio of raw materials is about 30:1. Many composting guidebooks and manuals provide C:N ratios of common organic materials, allowing workers to combine wastes and estimate the resulting C:N ratio. Paper, sawdust and dried leaves have high C:N ratios, while grass, plant cuttings, and fruit and vegetable scraps are high in nitrogen. Animal carcasses have a relatively low C:N ratio of about 5:1.

The pH is also an important factor for ensuring that the bacteria degrading the waste can survive. The pH scale is a measure of the acidity or alkalinity of soil, with 7 considered “neutral”, numbers less than 7 acidic, and numbers greater than 7 alkaline. The pH of the compost pile will fluctuate during the decomposition process, with a pH range of 5.5 to 8 being the most conducive to the microorganisms. The pH should be monitored and adjusted.

Aerobic oxidation does not smell bad. If odours are present, either the process is not entirely aerobic or there are materials present, arising from other sources than the oxidation that have an odour. Aerobic decomposition or composting can be accomplished in pits, bins, stacks or piles, if adequate oxygen is provided. To maintain aerobic conditions, it is necessary to add oxygen by turning the pile occasionally or by some other method. After the compost pile is no longer hot, worms, insects and fungi further break up the material.

To ensure proper conditions for composting, it may be helpful to mix pathological waste with other biodegradable waste, such as garden waste or food waste, as well as leaves, wood chips, sawdust and shredded paper, to increase the C:N ratio. Aerobic composting of placenta and pathological waste is possible. The wet waste (especially placenta) provides moisture needed to support the metabolic activity of the microorganisms, which require a moisture level of 40–65%. Aerobic composts of pathological waste should be aerated mechanically. Manual turning of a compost pile containing pathological waste is not recommended, especially in the early phase of decomposition. Some hospitals in the Philippines have composted placentas in rotating compost tumblers with the addition of a soil mixture containing beneficial microorganisms. The compost is then used in the gardens on the hospital grounds.

A6.3 Vermi-composting

Vermi-composting is the degradation of biological substances by worms. This kind of composting uses worms that thrive in decomposing organic matter to speed up the composting process. Worms not only ingest partly composted material, but also continually re-create aeration and drainage tunnels as they move through the compost. As worms digest organic matter, they generate vermicast, a brown soil-like material that is high in nutrients and can be used as a soil conditioner. The result is homogeneous and stabilized humus.

Vermi-composting of biodegradable municipal solid waste is done in many places. However, there is comparatively little information about using the same vermi-composting techniques to treat and dispose of pathological waste – although it is used in several locations for this purpose. For example, the General Santos Doctors Hospital in South Cotabato, Philippines, uses vermi-composting of placenta and kitchen waste. In India, a successful test was conducted on vermi-composting of infected biomedical waste, which reported elimination of *Escherichia coli*, *Staphylococcus aureus*, *Pseudomonas* sp. and *Proteus* sp. during the process (Mathur, Verma & Srivastava, 2006).

A6.4 Anaerobic digestion (fermentation)

Composting without oxygen results in fermentation. This causes organic compounds to break down by the action of living anaerobic organisms. As in the aerobic process, these organisms use nitrogen, phosphorus and other nutrients in developing cell protoplasm. However, unlike aerobic decomposition, this reduces organic nitrogen to

organic acids and ammonia. Carbon from organic compounds is released mainly as methane gas (CH_4). A small portion of carbon may be respired as CO_2 . The resulting methane gas can be processed and offers the potential for cheap, low-cost energy for cooking and lighting.

Anaerobic composting may be accomplished in large, well-packed stacks or biodigesters. Stacks should contain 40–75% moisture, into which little oxygen can penetrate. Waste for biodigesters should contain 80–99% moisture so that the organic material is a suspension in the liquid. If necessary, water can be added to reach the desired moisture content.

Biodigester designs come in many forms, the most common of which is the dome form. Figure A6.2 illustrates a small-scale low-cost version made from water tanks.

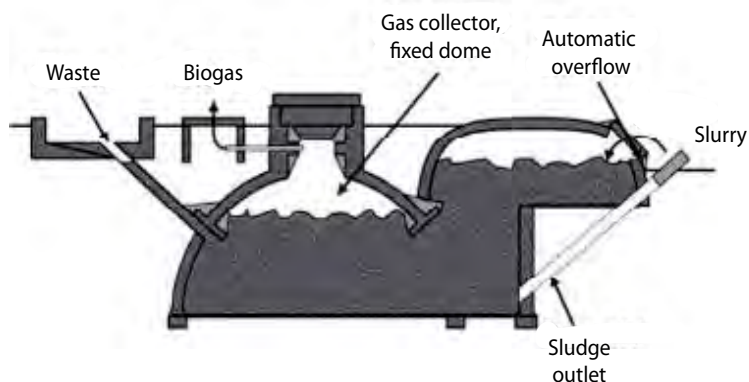

Design by Camartec, cited in Riuzzi (2009)

Figure A6.2 A dome biogas digester

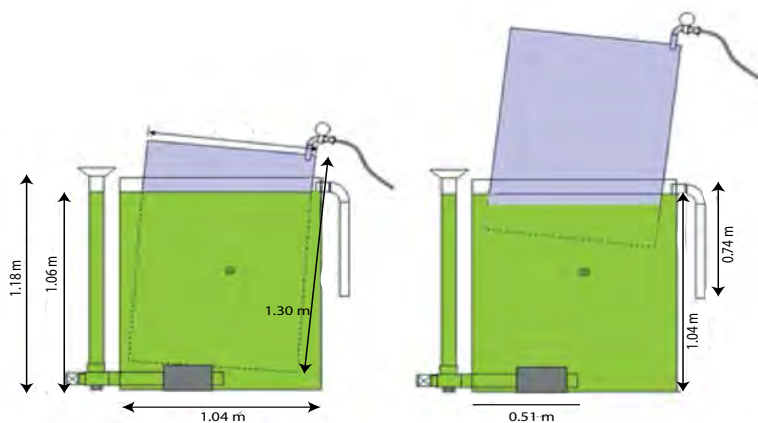

ARTI design compact biogas plant, made from one 750-litre and one 1000-litre water tank (Riuzzi, 2009)

Figure A6.3 A biogas plant

As described above, waste is usually introduced into the biodigester system in a liquid or slurry form. Manure is often used at the start of the process to provide the bacteria required. As the anaerobic bacteria degrade the waste, they generate gases, predominantly methane and carbon dioxide. These rise to the top of the dome (or storage tank, depending on the design) from where they can be tapped off. They can be used as a renewable fuel source. Digested slurry or sludge will either overflow automatically or can be tapped off periodically. Once this slurry has been tested to ensure that no pathogens have passed through, it can be used as fertilizer.

As with composting, the macro-parameters, such as the C:N ratio, water content and so on, are critical to the performance of anaerobic digestion systems. These systems also require a large volume of waste to function properly. Hence, it is unlikely that anaerobic digestion systems would be appropriate for placental or pathological waste alone. However, as much as 25% of the total waste arising from hospitals can be food waste and, where there is no sewage system, anaerobic digestion can be used in place of septic tanks. Anaerobic digestion systems based on these as the primary waste stream should be able to process placental or pathological waste (not laboratory waste) safely.

Anaerobic systems can operate at different temperatures: psychrophilic (5–15 °C), mesophilic (25–40 °C) or thermophilic (55–70 °C). The higher temperature systems destroy pathogens more quickly. Most research has been done with enteric pathogens because of the widespread application of anaerobic digestion to farm manure and human sewage.

Research has shown that a bench-scale thermophilic digester operating at 55 °C can remove all coliforms, faecal coliforms and faecal streptococci in 15 days, while the mesophilic version at 35 °C takes 35 days (Amani, Nosrati & Sreekrishnan, 2011).

Ascaris are nematode worms that can infest the intestines. They are generally regarded as the most resistant disease parasites in wastes. A separate research study showed that a thermophilic system (55 °C) reduced counts of Enterobacteriaceae, thermotolerant coliforms and faecal streptococci to below 103 per 100 ml, rendered cytopathic enteroviruses undetectable and destroyed the viability of *Ascaris suum* ova within four hours. The mesophilic process (35 °C) reduced bacterial counts by 90% and enteroviruses by 99%, but had no effect on the viability of *Ascaris* ova (Carrington et al., 1991).

Therefore, anaerobic digestion should be monitored closely, and should occur in a controlled system. If *Ascaris* eggs are not destroyed by the anaerobic digestion, the composted material must be held for periods of six months to a year to ensure relatively complete destruction.

A6.6 References

Amani T, Nosrati M, Sreekrishnan TR (2011). A precise experimental study on key dissimilarities between mesophilic and thermophilic anaerobic digestion of waste activated sludge. *International Journal of Environmental Resesarch*, 5(2):333–342.

Carrington et al. (1991). Destruction of faecal bacteria, enteroviruses and ova of parasites in wastewater sludge by aerobic thermophilic and anaerobic mesophilic digestion. *Water Science and Technology*, 24(2):377–380.

Mathur UB, Verma LK, Srivastava JN (2006). Effects of vermicomposting on microbiological flora of infected biomedical waste. *Journal of Indian Society of Hospital Waste Management*, 5(1):21–27.

MSF (Médecins Sans Frontières) (2010). *Public health engineering in precarious situations*, 2nd ed. Geneva, Médecins Sans Frontières (http://www.refbooks.msf.org/MSF_Docs/En/Public_health_en.pdf).

MSF. Technical Brief 6.08: *Organic waste pit (“placenta” pit)*. Geneva, Médecins Sans Frontières.

Riuji LC (2009). *Research on anaerobic digestion of organic solid waste at household level in Dar es Salaam, Tanzania* [thesis]. Zurich, Zurich University of Applied Sciences.

Further reading

Anaerobic digestion. Cardiff, Cardiff University, 2005.

Whatcom County Extension (2011). *Anaerobic fermentation*. Bellingham, Washington State University (http://whatcom.wsu.edu/ag/compost/fundamentals/biology_anaerobic.htm).

Doelle HW (2001). Biotechnology and human development in developing countries, *Electronic Journal of Biotechnology* (<http://www.ejbiotechnology.info/content/vol4/issue3/issues/02>).

Friends of the Earth (2007). *Anaerobic digestion briefing paper*, London, Friends of the Earth (http://www.foe.co.uk/resource/briefings/anaerobic_digestion.pdf).

Herrero JM (2007). Transfer of low-cost plastic biodigester technology at household level in Bolivia. *Livestock Research for Rural Development*, 19(12).

Marchaim L (1992). *Biogas processes for sustainable development*. Rome, Food and Agriculture Organization of the United Nations (<http://www.fao.org/docrep/T0541E/T0541E00.htm#Contents>).

MSF (Médecins Sans Frontières). Technical Brief 4.05: *Soil stability and permeability tests*. Geneva, Médecins Sans Frontières.

Wagner EG, Lanoix JN (1958). *Excreta disposal for rural areas and small communities*. Geneva, World Health Organization.

Glossary

The definitions given in this glossary refer to the use of terms in this handbook and are not necessarily valid in other contexts.

Activity	Disintegration of an amount of a radionuclide in a particular energy state at a given time per time interval.
Antineoplastic	Inhibiting or preventing the development of neoplasms.
Antisepsis	Prevention of infection by inhibiting the growth of infectious agents.
Calorific value	See <i>heating value</i> .
Capacity	The quantity of solid waste that can be processed in a given time under certain specified conditions, usually expressed in terms of mass per 24 hours.
Characterization	The determination of the physical and chemical and – for radioactive waste – radiological properties of waste, or of other features, to establish the need for further adjustment, treatment or conditioning, or suitability for further handling, processing, storage or disposal.
Clearance levels (in the context of radioactive waste management)	A set of values established by the regulatory authority and expressed in terms of activity concentrations and/or total activities, at or below which sources of radiation can be released from regulatory control.
Cluster	Group of institutions, agencies, nongovernmental organizations forming a sectoral committee in an emergency situation (e.g. health cluster) for coordinating the implementation in that sector and developing specific standards for the delivery of assistance.
Conditioning	Operations that produce a package suitable for handling, transportation, storage and/or disposal.
Container	Vessel in which waste is placed for handling, transportation, storage and/or eventual disposal. The waste container is a component of the waste package.
Contingency planning and emergency preparedness	A programme of long-term development activities whose goals are to strengthen the overall capacity and capability of a country to manage efficiently all types of emergency and to bring about an orderly transition from relief through recovery and back to sustained development.
Cytostatic	Causing suppression of growth and multiplication of cells.
Cytotoxic	Possessing a specific destructive action on certain cells; used in particular in referring to the lysis (disintegration or dissolution) of cells brought about by immune phenomena and to antineoplastic drugs that selectively kill dividing cells.
Decontamination	Reduction of microbiological contamination to a safe level.
Disasters	Events that occur when significant numbers of people are exposed to extreme conditions to which they are vulnerable, with resulting injury and loss of life, often combined with damage to property and livelihoods.
Disaster-management cycle	Consists of a continuous chain of activities of disaster management that include hazard prevention, preparedness, emergency response, relief and recovery, such as activities to reconstruct infrastructure and rehabilitate shattered lives and livelihoods. For the purposes of this handbook, the following three major phases have been chosen: rapid initial assessment, emergency response and recovery.
Disinfectant	Chemical agent that is able to reduce the viability of microorganisms.

Disinfection	Treatment aimed at reducing the number of vegetative microorganisms to safe or relatively safe levels.
Disposal	Intentional burial, deposit, discharge, dumping, placing or release of any waste material into or on any air, land or water. In the context of radioactive waste management, disposal means the placement of waste in an approved, specified facility (e.g. near-surface or geological repository) or the approved direct discharge of effluents into the environment. Disposal is undertaken without the intention of retrieval.
Emergencies	Situations that arise out of disasters in which the affected community's ability to cope has been overwhelmed, and where rapid and effective action is required to prevent further loss of life and livelihood.
Emergency medical care activities	All types of health-care activities implemented during emergencies.
Exempt waste (in the context of radioactive waste management)	Waste that is released from nuclear regulatory control in accordance with clearance levels because the associated radiological hazards are negligible. The designation should be used in terms of activity concentration management and/or total activity, and may include a specification of the type, chemical/ physical form, mass or volume of waste, and its potential use.
Flue gas (or exhaust gas)	Gases and suspended particles emitted from an industrial stack or chimney.
Furnace	The chamber of the incinerator into which the refuse is charged for subsequent ignition and burning.
Genotoxic	Descriptive of a substance that is capable of interacting directly with genetic material, causing DNA damage that can be assayed. The term may refer to carcinogenic, mutagenic or teratogenic substances.
Groundwater	The water contained in porous underground strata as a result of infiltration from the surface.
Handling	The functions associated with the movement of solid waste materials, excluding storage, processing and ultimate disposal.
Hazard	Intrinsic potential property or ability (e.g. of any agent, equipment, material or process) to cause harm. Note: harm is an injury or damage to health of people and/or to the environment.
Heating value (or calorific value)	The quantity of heat that is produced when the unit mass of a material undergoes complete combustion under certain specified conditions. For solids, it is expressed in terms of calories or joules per kilogram (kcal/kg, kJ/kg, MJ/kg, etc.). The high heating value includes the specified enthalpy of vaporization, whereas the low heating value omits it.
Incineration	The controlled burning of solid, liquid or gaseous combustible wastes to produce gases and residues containing little or no combustible material.
Leachate	Liquid from a landfill containing substances that were present in the waste, either as liquids or as solids, and were dissolved by the water passing through the waste.
Microorganism	Any microbiological entity, cellular or non-cellular, capable of replication or of transferring genetic material.
Monitoring	The measurement of a concentration or other parameter (radiation or radionuclide concentration in the context of radioactive waste management) for purposes of assessment or control of environmental quality or exposure, and the interpretation of such measurements. Monitoring can be continuous or non-continuous.
Monofill	A landfill site that contains only one category of waste, with the bottom covered by a huge sheet of plastic to prevent the waste from coming in contact with the outside soil, particularly the groundwater. Since there is only one specific waste within the site, as technology is developed, it may become possible to dispose of the waste more efficiently and potentially recycle the waste completely.

Municipal waste	General waste for collection by municipalities, generated mainly by households, commercial activities and street sweeping.
Prion	A poorly characterized slow infectious agent. Prions are believed to be the cause of a number of neurodegenerative diseases (e.g. Creutzfeldt–Jakob disease).
Pyrolysis	The decomposition of organic material by heat in the absence, or with a limited supply, of oxygen.
Radioactive waste	Material that contains, or is contaminated with, radionuclides at concentrations or activities greater than clearance levels and for which no use is foreseen.
Radioimmunoassay	Assay or test involving radionuclides and using an antibody as the receptor.
Radionuclide	A nuclide (i.e. an atom of specified atomic number and mass number) that exhibits properties of spontaneous disintegration, liberating energy, generally resulting in the formation of new nuclides. This process is accompanied by the emission of one or more types of radiation, such as α - and β -particles and γ -rays.
Radiotherapy	The use of ionizing radiation to treat disease.
Recycling	Converting waste into a reusable material or returning materials to an earlier stage in a cyclic process. Note that recycling is distinct from reuse.
Repository	A nuclear facility where radioactive waste is emplaced for disposal. Future retrieval of waste from the repository is not intended.
Residence time	The time that elapses between the entry of a substance into a furnace or incinerator and the exit of exhaust gases or burn-out residue from the furnace or incinerator.
Residue	The material remaining after combustion of wastes such as ash or slag. Also refers to materials extracted from a liquid or gas stream.
Risk	Probability that a hazard will cause harm in combination with the severity of that harm.
Sanitary landfilling	An engineered method of disposing of solid waste on land in a manner that protects the environment; for example, by spreading the waste in thin layers, compacting it to the smallest practical volume, covering it with soil by the end of each working day, constructing barriers to infiltration, and evacuating the gases produced.
Scavenging	The manual sorting of solid waste at landfills or dumpsites, and removal of usable material.
Sealed source	Radioactive material that is permanently encapsulated or closely bound in a solid form to prevent its release under the most severe conditions likely to be encountered in normal use and handling.
Segregation	The systematic separation of solid waste into designated categories.
Sewage	A community's water supply after it has been fouled by various uses. Its source may be a combination of the liquid or water-carried wastes from domestic, municipal and industrial premises, together with such groundwater, surface water and stormwater as may be present.
Sewerage	A system for the collection and transport of sewage, including conduits, pipes and pumping stations.
SI	Abbreviation for the <i>Système International d'Unités</i> , a system of units of measurement developed to permit international harmonization and acceptability.
Sludge	The accumulated solids that separate from liquids such as water or wastewater during processing. Distinct from sediments, which are deposits on the bottom of streams or other bodies of water.
Sterilization	A reduction in microorganisms of more than 10^6 (more than 99.9999% of the microorganisms are killed), achieved by physical, chemical or mechanical methods, or by irradiation.
Stoichiometric	Describes a quantitative relationship, usually expressed as the ratio between two or more substances undergoing a physical or chemical change; the point at which the reaction ends or stabilizes.

Storage	The placement of waste in a suitable location or facility where isolation, environmental and health protection, and human control (e.g. monitoring for radioactivity, limitation of access) are provided. This is done with the intention that the waste will be subsequently retrieved for treatment and conditioning and/or disposal (or clearance of radioactive waste).
Teletherapy	Therapeutic irradiation in which the source of irradiation is located at a distance from the patient's body.
Telemedicine	Rapid access to shared and remote medical expertise by means of telecommunications and information technologies, no matter where the patient or relevant information is located. Telehealth is a method of source reduction – it can reduce the need for clinical visits and reduce the transportation (carbon footprint) as well as the wastes produced from clinical activities.
Treatment	Any method, technique or process for altering the biological, chemical or physical characteristics of waste to reduce the hazards it presents and facilitate, or reduce the costs of, disposal. The basic treatment objectives include volume reduction, disinfection, neutralization or other change of composition to reduce hazards, including removal of radionuclides from radioactive waste.
Waste generator	Any person, organization or facility engaged in activities that generate waste.
Waste inventory	In the context of radioactive waste management, a detailed, itemized record maintained by the operator or regulatory authority in accordance with established regulations; it may contain data such as physical quantity, infectivity or radioactivity of the waste, and the radionuclide content.
Waste management	All the activities, administrative and operational, involved in the handling, treatment, conditioning, storage and disposal of waste (including transportation).
Waste package	The product of waste conditioning, which includes the waste form, waste container(s) and any internal barriers (e.g. absorbing materials or liners), prepared in accordance with requirements for handling, transportation, storage and/or disposal.

Further reading

IAEA (International Atomic Energy Agency) (1993). *Radioactive waste management glossary*. Vienna, International Atomic Energy Agency.

Shleien B, ed. (1992). *The health physics and radiological health handbook*, revised ed. Silver Spring, MD, Scinta.

Stedman TL (1995). *Stedman's medical dictionary*, 26th ed. Baltimore, MD, Williams & Wilkins.

WHO (World Health Organization) (1980). *Glossary on solid waste*. Copenhagen, World Health Organization Regional Office for Europe.

Safe management of wastes from health-care activities – Second edition

The waste produced in the course of health-care activities, from contaminated needles to radioactive isotopes, carries a greater potential for causing infection and injury than any other type of waste, and inadequate or inappropriate management is likely to have serious public health consequences and deleterious effects on the environment. This handbook – the result of extensive international consultation and collaboration – provides comprehensive guidance on safe, efficient, and environmentally sound methods for the handling and disposal of health-care wastes in normal situations and emergencies. Future issues such as climate change and the changing patterns of diseases and their impacts on health-care waste management are also discussed.

The various categories of waste are clearly defined and the particular hazards that each poses are described. Considerable prominence is given to the careful planning that is essential for the success of waste management; workable means of minimizing waste production are outlined and the role of reuse and recycling of waste is discussed. Most of the text, however, is devoted to the collection, segregation, storage, transport, and disposal of wastes. Details of containers for each category of waste, labelling of waste packages, and storage conditions are provided, and the various technologies for treatment of waste and disposal of final residues are discussed at length. Advice is given on occupational safety for all personnel involved with waste handling, and a separate chapter is devoted to the closely related topic of hospital hygiene and infection control.

For health-care settings in which resources are severely limited, the handbook pays particular attention to basic processes and technologies that are not only safe, but also affordable, sustainable, and culturally appropriate.

The guide is aimed at public health managers and policy-makers, hospital managers, environmental health professionals, and all administrators with an interest in and responsibility for waste management. Its scope is such that it will find application in developing and developed countries alike.

Department of Public Health,
Environmental and Social
Determinants of Health

World Health Organization
Geneva 27, CH-1211
Switzerland
www.who.int/phe

